



PURSUIT[®]

"SCIENCE IS THE PURSUIT OF THE UNEXPLAINED"

VOL. 6 NO. 4

OCTOBER, 1973

SOCIETY FOR THE INVESTIGATION OF THE UNEXPLAINED

Columbia, New Jersey 07832
Telephone: Area Code 201 496-4366

MEMBERSHIP

Membership is \$10 a year and runs from the 1st of January to the 31st of December. Members receive our quarterly journal PURSUIT, an Annual Report and Auditor's Report, and all special Society publications for that year.

Members are welcome to visit our Headquarters if they wish to use the Library or consult the staff but, due to limited facilities, this can be arranged only by prior appointment; and at least a week in advance.

- YOU DON'T HAVE TO BE A PROFESSIONAL OR EVEN AN AMATEUR SCIENTIST TO JOIN US.

ORGANIZATION

The legal and financial affairs of the Society are managed by a Board of Trustees in accordance with the laws of the State of New Jersey. The Society is also counselled by a panel of prominent scientists, which is designated the Scientific Advisory Board.

The Society is housed on eight acres of land in the Township of Knowlton, Warren County, New Jersey.

IMPORTANT NOTICES

- The Society is completely apolitical.
- It does not accept material on, or presume to comment upon any aspects of Human Medicine or Psychology; the Social Sciences or Law; Religion or Ethics.
- All contributions, but not membership dues, are tax deductible, pursuant to the United States Internal Revenue Code.
- The Society is unable to offer or render any services whatsoever to non-members. Further, the Society does not hold or express any corporate views, and any opinions expressed by any members in its publications are those of the authors alone. No opinions expressed or statements made by any members by word of mouth or in print may be construed as those of the Society.

PUBLICATIONS

Our publishing schedule is four quarterly issues of PURSUIT, dated January, April, July, and October, and numbered as annual volumes — Vol. 1 being 1968 and before; Vol. 2, 1969, and so on. These are mailed at the end of the month. (Subscription to PURSUIT, without membership benefits, is \$5 for 4 issues.) Order forms for back issues will be supplied on request.

PURSUIT is listed in Ulrich's International Periodicals Directory and in the Standard Guide to Periodicals; and is abstracted in Abstracts of Folklore Studies. It is also available from University Microfilms, 300 N. Zeeb Rd., Ann Arbor, Michigan 48106. The price is \$4.10 per reel. An annual index appears in the October issue.

Vol. 6, No. 4
October, 1973

PURSUIT®

THE JOURNAL OF THE SOCIETY FOR THE
INVESTIGATION OF THE UNEXPLAINED

DEVOTED TO THE INVESTIGATION OF "THINGS"
THAT ARE CUSTOMARILY DISCOUNTED

Editor & Publisher: Hans Stefan Santesson
Executive Editor: Marion L. Fawcett
Consulting Editor: Walter J. McGraw
Assistant Editor: Robert J. Durant

CONTENTS

Editorial, by Hans Stefan Santesson	78
<u>Chaos and Confusion</u>	
Whose Point of View?	78
The Avenger Flight; and Others	79
Mermaids	80
He Talked with the Seagulls	81
<u>Astronomy</u>	
The Tunguska "Meteorite"	82
<u>Geology</u>	
Lightning Again	82
London for Darknesses?	82
Pre-Earthquake Phenomena	83
<u>Biology</u>	
ABSMal Affairs in Pennsylvania and Elsewhere, by Allen V. Noe	84
<u>Anthropology</u>	
Not the Salzburg Steel Cube, but an Iron Object from Wolfsegg, by Hubert Malthaner	90
The Chinese Pyramid	93
<u>Members' Forum</u>	95
<u>Department of Loose Ends</u>	96
<u>Book Reviews</u> , by Sabina W. Sanderson	97
<u>Index for 1973</u>	99

EDITORIAL

A number of quasi-semantic crimes have undoubtedly been committed by enthusiastic pseudo-Forteans, at times even in the pages of this publication, in part, as Hubert Malthaner points out by implication in this issue, because of the desire of dilettante archaeologists to prove the case for the existence, in remote pre-historic times, "of civilizations on this earth far surpassing our own in technological development". Colonel Churchward is obviously the classic example of this rather casuistic approach to pre-history, which rationalizes the selective "editing" of references cited in support of the case for the prior existence of these civilizations. Latterday Churchwards, not content with paraphrasing Helena Petrovna Blavatsky without due credit, and shifting happenings from the Caribbean to the Pacific, have of course shown a marked talent for blatant plagiarism of earlier plagiarists, and also been inclined to paraphrase not only not wisely but all too well. The result has been decidedly confusing.

We are concerned at SITU not with this pseudo-Fortean approach to pre-history, but with the evidence, as yet unexplained by the technicians who have pontificated on the subject in the past, which adds up to the possibility that ours is possibly not the best of all possible worlds but simply the most recent chapter in man's repeated efforts to reach the stars.

We tend to view with suspicion anything which suggests that we may in fact have come this way before. We ignore the historical precedents which should remind us of how technicians, administrators, bureaucrats as truly sanctified in their days as in ours, have in the known past prevented earlier advances, ignoring want and hunger and ignoring misery and injustices in their no doubt understandable preoccupation with formulae aimed at prolonging the status quo of the day.

It is tempting, but intellectually dishonest, to dismiss out of hand the possibility that civilizations have risen and fallen and literally vanished into the mists of time on this world of ours, solely because of the excesses of these latterday Churchwards whose sins are obvious and whose devotion to truth may properly be questioned.

If we therefore recognize this possibility, and extrapolate from the known to the presumed, we are legitimately speculating on a subject which has intrigued thousands, including many of our members, throughout these and earlier years. We would be lacking in the humility demanded of students of history if we thus denigrate this possibility solely because of the best-selling charlatans who have in recent years muddied the waters.

This is assuming we pay more than lip-service to our description of ourselves as Forteans, and that we have a certain sense of history to which so many among us are proudly alien.

Hans Stefan Santesson

CHAOS & CONFUSION

WHOSE POINT OF VIEW?

A cartoon reprinted from Punch, the famous English comic magazine, shows two apes (variety not distinguishable) in a cage and a little man in another corner of a room. The caption reads "It's most interesting, by pushing this lever 20 times you can get him to walk across here with a banana."

Obviously, this is intended to be funny, but we did a kind of mental double-take after reading it. How do we know that this isn't the reaction—the true one—of animals subjected to various tests designed to measure their intelligence, adaptability, etc? Actually, we don't. But we are so certain of our superior mentality that it seldom occurs to us to even consider the possibility that such tests may work both ways.

There is a common notion that animals (i.e., properly "mammals") do not "think", though just what is meant by this word I am not certain; and that one must not attribute human emotions to other animals. If an animal shows apparent affection for its young, this is put down to instinct—a catch-all word if there ever was one—but not to the 'fact' that the

animal may indeed be fond of its offspring. Ivan Sanderson, in his book The Dynasty of Abu (still in print, Alfred A. Knopf, NYC), includes the story of a female elephant tested for her mental capacity and memorizing ability at a scientific institute in Germany. The gentlemen who did the testing noted that after a few trials the elephant "became much annoyed, but usually chose the neutral, just in case"; and Ivan Sanderson concluded that "Her peeve was apparently with the nature of the experiment, not with its result". It would seem to be impossible to become peeved if you cannot 'think'.

Certainly, much of animal behaviour, including our own (though this notion may not be popular), is "instinctive" but it probably is a mistake to assume that all of it is. On many occasions I have watched our dogs lying on the lawn and obviously calculating their chances of catching a groundhog pottering about on the periphery of the lawn. (Here I should put on record that on one occasion a young groundhog was found approximately 7 feet up in an apple tree at one end of the lawn: the trunk is vertical for the first 4 feet. I was not aware that they could climb.)

It is impossible to draw any firm conclusions from any of this, but it is perhaps a good idea to keep it all in mind.

THE AVENGER FLIGHT; AND OTHERS

The unexplained loss of a flight of five Navy torpedo bombers off the Florida coast in December, 1945, was the incident that began the entire "Vile Vortices" business. This is not to say that the Navy planes were the first to disappear in that area in strange circumstances. On the contrary, there are records of hundreds of disappearances of ships and aircraft in the so-called "Triangle" as well as a tradition of suspicious goings-on that dates back several hundred years. But the loss of the five torpedo bombers, and of a search plane sent after them (but see below), brought the situation very dramatically to the attention of the public. Writers such as Vincent Gaddis (Invisible Horizons) and Ivan Sanderson (Invisible Residents) collated a large number of case histories from the Triangle and offered the Navy incident in the context of a long and continuing history of unexplained occurrences.

The U. S. Navy makes exhaustive investigations of accidents that occur to its ships and aircraft. The loss of the five torpedo bombers and the search plane touched off an unusually detailed study. The transcript of the official board of inquiry is the basic source document for data on the incident, but it has been a difficult matter to get access to it. The report has been available to the public, but only to those willing and able to visit an obscure office in the Bureau of Naval Personnel in Washington. Furthermore, only the testimony and exhibits were available—the conclusions of the board of inquiry were kept under wraps. Apparently the Navy feared legal problems might result from the release of the conclusions of the board. However, the Navy did inform us (this was long after Invisible Residents was published), "off the record", that the board pinned full responsibility on the leader of the flight, and concluded that he had simply lost his way, panicked, and eventually led the flight out to sea where it ran out of fuel.

We are pleased to report that Member #372 has recently succeeded in convincing Naval officials that the entire report, including the conclusions of the board, should be made public. Furthermore, the Navy has agreed to make microfilm copies for general distribution. This may be ordered from Operational Archives Branch, Naval Historical Center, Washington Navy Yard, Bldg. 210, Washington, DC 20374; the price is \$4.00, and requests should specify that this is the case of the five TBMs or Avengers lost on December 5, 1945.

The Navy should be commended for this forthright action, as should our member for his persuasiveness. Without both, the original report would probably be lost forever to serious researchers. It is true that the

new data in the report simply puts the blame on Lt. Taylor, the flight leader, and then corrects the findings to say that he wasn't to blame and that "the flight disappeared for reasons or causes unknown". (Even if he was, there are certainly some peculiarities still remaining.) Robert J. Durant, who has done much work on this, tells us that he has interviewed two pilots who were in the same training program and that their information "makes Lt. Taylor, the leader, look bad,... but really only serves to confuse the central question of 'what happened?'"

And the question of the Martin Mariner sent to look for the lost flight is most odd. The official Navy version is that it "disappeared" but that a flash of light was seen by a freighter in the area where the plane ought to have been and that it is believed that it probably blew up. A radio talk-show MC in Florida has told us that these planes were probably the worst death-traps of that era; gasoline fumes had a tendency to leak into the plane—one spark, and that was that—and that the crew of one plane in the squadron to which he was assigned and which was sent out shortly after the Martin flying boat, saw the plane blow up. If this is true, and our informant certainly was sincere, why didn't/doesn't the Navy know of this and say so?

While we are at it, Member #372 has also eliminated one of the vessels formerly believed to be connected with the mystery of the "Triangle". This is the John and Mary, listed by both Gaddis and Sanderson, and just about everyone else. The SS West Quechee sighted the 125-foot fishing schooner at 31°29' North and 63°29' West, southeast of Bermuda, at 4:45 p.m. on the 16th April, 1932; the crew and the ship's papers and documents were missing. Our member checked through Coast Guard records on derelict ships and found that:

"All of the six crew members had already been rescued on March 8, 1932, by the master motorship Tidewater. There had been an explosion in the engine room of the John and Mary, after which the crew panicked, abandoning the ship hastily at 1:38 p.m. The crew was soon picked up and had brought the ship's papers with them. The location of the abandonment was at 36°58' North and 69°50' West.

"It was found that the engine had exploded but no other damage had been done, so it was taken into tow as a derelict."

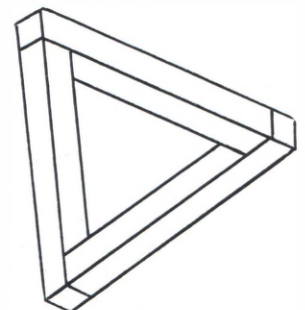

The Impossible Triangle

MERMAIDS

Mermaids have been a popular topic for many years, one viewpoint being that these were simply manatees or dugongs seen by love-starved sailors, and the other that mermaids really exist. I have always been inclined to believe that it was pretty close to libel to suggest that sailors were this blind, but there proves to be another facet to this, as reported in Elaine Morgan's book The Descent of Woman (reviewed in this issue). Mrs. Morgan says, "...a report on the dugong by H. A. F. Goohar...offers the most probable solution to the mystery of the mariner and the mermaid. It points out that there is a striking resemblance between the genitalia of dugongs and those of human beings; and that in the Red Sea area there is an oral tradition that in former centuries a sailor after months at sea who found a dugong in the shallows—large, docile, warm-blooded, air-breathing, smooth-skinned, female-breasted. and with ventral genital organs which remarkably well fitted his own—wouldn't worry over-much if she was comparatively faceless." This is certainly a more rational explanation than the mere suggestion that sailors saw dugongs or manatees and mistook them for beautiful women.

On the other hand, many reports of mermaids come from areas in which no sirenian has ever been found and in which they could not survive, e.g. in the northern latitudes. There have been some deliberate hoaxes and publicity stunts, but there are other reports which cannot be so easily dismissed. One such report is included in Sea Enchantress by Gwen Benwell and Sir Arthur Waugh (New York, The Citadel Press, 1965; pp. 113-114):

"Deposition by John M'Isaac, a farmer,...

"At Cambeltown, twenty-ninth of October, 1811. In presence of Duncan Campbell, Esq., Sheriff-substitute of Kintyre, appeared John M'Isaac, tenant in Corphine...solemnly sworn and examined depones.... That about three or four o'clock of the afternoon of Sunday the eighteenth current having taken a walk towards the seaside, he came to the edge of a precipice above the shore, from which he saw the appearance of something white upon a black rock at some distance from him.... He crept upon all fours... until he came within twelve or fifteen paces of the rock where it lay: That, upon looking at the object with attention, he was impressed with great surprise and astonishment at its uncommon appearance.... That the upper half of it was white, and of the shape of a human body, and the other half towards the tail of a brindled reddish-grey colour apparently covered with long hair; and as the wind blew off the land, it sometimes raised the hair over the creature's head, and every time the gust of wind would do this, the animal would lean towards one side, and taking up the opposite hand, would stroke the hair backwards, and then leaning upon the other side of its head in the same manner. That at the same time, the animal would put

back the hair on both sides of its head in this manner; it would also spread or extend its tail like a fan, to a considerable breadth, and while so extended, the tail continued in tremulous motion and when drawn together again it remained motionless and appeared to the deponent to be about twelve or fourteen inches broad lying flat upon the rock.... That the animal, upon the whole, was between four and five feet long, as near as he could judge: That it had a head, hair, arms, and body, down to the middle like a human being, only that the arms were short in proportion to the body which appeared to be about the thickness of that of a young lad, and tapering gradually to the point of the tail:.... (observer watched for near two hours) ...he saw its face, every feature of which he could distinctly mark, and which to him had all the appearance of the face of a human being, with very hollow eyes...the cheeks were of the same colour with the rest of the face: That the neck seemed to be short....(could not see the chest, half submerged in the water, so could not say if it were male or female) All which he declares to be truth as he shall answer to God; and depones he cannot write.

DUNCAN CAMPBELL, Sheriff-Substitute"

Witnesses: Rev. Doctor George Robertson and Mr. Norman MacLeod, minister of Campbeltown, and James Maxwell, Esq., Chamberlain of Mull.

A second report is taken from Silliman's American Journal of Science, Vol. II (1820), pp. 178-179, and is identified as an extract from the log book of the ship Leonidas, "sailing from New-York towards Havre, Asa Swift master; May 1817. Lat. 44°, 6' north". It was "communicated to Benjamin Silliman by Mr. Elisha Lewis of New-Haven, a respectable merchant", and reads as follows:

"First part of the day light variable winds and cloudy; at two P.M. on the larboard quarter, at the distance of about half the ship's length, saw a strange fish. Its lower parts were like a fish; its belly was all white; the top of the back brown, and there was the appearance of short hair as far as the top of its head. From the breast upwards, it had a near resemblance to a human being and looked upon the observers very earnestly; as it was but a short distance from the ship, all the afternoon, we had a good opportunity to observe its motions and shape. No one on board ever saw the like fish, before; all believe it to be a Mermaid.

"The second mate Mr. Stevens, an intelligent young man, told me the face was nearly white, and exactly like that of a human person; that its arms were about half as long as his, with hands resembling his own; that it stood erect out of the water about two feet, looking at the ship and sails with great earnestness. It would remain in this attitude, close along side, ten or fifteen minutes at a time, and then dive and appear on the other side. It remained around them about six hours. Mr. Stevens also stated that its hair was black on the head and exactly resembl-

ed a man's; that below the arms, it was a perfect fish in form, and that the whole length from the head to the tail about five feet."

Both these accounts are very straightforward, and it is unlikely that either was simply "made up". Under English law, perjury is a very serious offense — what the penalty was in 1820 I do not know, but it must certainly have been sufficient to deter anyone from making such a deposition unless he were very sure of his facts. Also, Mr. M'Isaac's daughter made a similar deposition, stating that she had seen the 'creature' on another occasion; and the Witnesses were convinced of Mr. M'Isaac's sincerity.

As for the entry in the log of the Leonidas, it was an offense to make an incorrect entry and ship captains had better things to do with their time than to write down fairy tales that could easily discredit them with ship owners.

Neither report has much in common with 'legendary' mermaids, the beautiful blondes who lure sailors to their doom by singing at them. In fact these mermaids don't sound at all attractive, but they do share one peculiarity: noticeably short arms. This is an odd thing to make up if you are concocting a story.

Whether M'Isaac's deposition was widely published and might have been seen by Mr. Stevens, the second mate of the Leonidas, is unknown, but even if it was, the initial report must still be considered to be an accurate description of what John M'Isaac saw.

None of this proves anything, but it does suggest that reports of mermaids should be given more consideration than is often the case.

HE TALKED WITH THE SEAGULLS

Our member #1434 has sent us a number of accounts of unusual events in his part of the world, but perhaps the most unusual — though it is not strictly within our province — is the following. (We do not have permission to use the full name of the witness.)

"Dick B. was working in some of the more remote areas of Alaska in the early 50s. One morning an older Amerind laborer disappeared for a while. When he returned, he was very concerned about his wife, stating that she was ill and that he had to go to her. The only available communication was a shortwave

radio which, at that time, was not working. The Amerind explained that he had gone and talked with the seagulls who told him that his wife was seriously ill and he had to go to her. She was 500 miles away.

"Later that day a plane came through heading north, and the Amerind went along.

"As soon as the radio was repaired, the pilot was contacted and he reported that upon landing at the island the wife's illness was confirmed. There had been no advance notice of the Amerind's arrival, and yet, the only auto on the island was waiting to deliver them to the village some 13 miles distant. The pilot had no explanation for the fact that the taxi was there to meet them.

"When the Amerind returned to his job, he commented casually that it was a good thing that he had gone to talk with the seagulls."

This is really most extraordinary, though there are possible theories that come to mind. Amerinds in many places are, or at least used to be, noted for using smoke signals, and these are also used by the Australian Aborigines. In some cases the smoke signals themselves convey a message, but in others (and this seems to be particularly true of the Australians) the smoke signals seem to be simply an attention-getting device, the message actually being sent by "mental telepathy". It is also true that many so-called mediums use their crystal balls, tea leaves, or whatever, not as sources of information per se but as objects which help them to concentrate, the 'message' coming from some other 'source'. It seems unlikely that seagulls as such convey even simple bits of information from one human to another, but it is possible that a tribe or even a family of Amerinds might choose, say, a seagull as a sort of guardian angel and thus an unwitting intermediary in an exchange of news by what is now called mental telepathy. It is unfortunate that the Amerind was not quizzed more thoroughly but this, of course, may not have been possible for many reasons.

The modus operandi of mental 'telepathy' is not understood at the present time, but we believe it likely that it, too, will prove to be a physical phenomenon, operating on a "wavelength" not yet detectable by us.

If any of our members know of similar occurrences, we will be happy to hear of them.

David Scott-Moncrieff, head of David Scott-Moncrieff & Son Ltd., Purveyors of Horseless Carriages to the Nobility and Gentry since 1927, is the 'limericist' whose work was quoted in our July issue. Herewith another of his efforts:

The monster that lives in Loch Ness
Said he lived in the days of Queen Bess.
When they said "Do you mean
That you lived WITH the Queen?"
He replied with a wink, "More or less".

V. ASTRONOMY

THE TUNGUSKA "METEORITE"

Still another theory to explain the explosion and odd pattern of damage at Tunguska in Siberia in 1908 has been put forward by A. A. Jackson 4th and Michael P. Ryan Jr., physicists at the Center for Relativity Theory at the University of Texas at Austin. Their suggestion is based on experiments carried out by Soviet scientists in 1966, which showed that the pattern of tree felling at Tunguska could have been caused by a "cylindrical explosion travelling down a wire at an angle of 30 degrees to the ground". This experiment was done with a scale model of the Tunguska site and produced an identical pattern to that found there.

Messrs. Jackson and Ryan suggest that all the effects noted at Tunguska, and also those recorded elsewhere at the time of that 'explosion', were produced by a "black hole" that plunged straight through the earth. "Black holes" are not, of course, "holes"

but incredibly dense and minute bodies that are believed to be the final stage in the collapse of a star. A black hole is described by Jackson and Ryan as "a grain of dust weighing a million billion tons and travelling at about 25,000 miles an hour when it hit the earth. If it entered at Tunguska, it would have exited somewhere in the North Atlantic between Newfoundland and the Azores, and it would have produced shock waves here also. They therefore suggest that ships' logs be examined for accounts of any unusual occurrences on the 30th June 1908 and that any other records of changes in air pressure in the North Atlantic should also be checked for confirmatory evidence.

It may never be possible to prove the cause of the devastation at Tunguska—comet head, "space ship", an antimatter meteorite, or a black hole—but the continued accumulation of evidence, not simply from the site itself but from other areas, may provide us with a probable answer.

VI. GEOLOGY

LIGHTNING AGAIN

One of our members, who prefers to be known as X, sends the following:

"Aside from Fort's comments on lightning's affinity for wedge-shaped objects, it has been known to do some crazy things such as fusing coins inside a pocket without causing other damage, fusing a live bullet to the barrel of a gun, and burning photographic images into glass. But the following incidents are my favourites.

"In the Scientific American (old series), 11-344: 'A Lightning Well Borer: During a recent thunderstorm at Kensington, N.H., the lightning descended perpendicularly in an intense discharge into a pasture field, and made a hole about a foot in diameter and 30 feet deep, forming a well which soon filled up with good water.' What better way to dig a well, but how does one get "perpendicular" lightning?

"And in the early morning of June 29, 1869 the residents of Pradettes, France, caught glimpses of a naked man sneaking about. The naked man turned out to be the mayor. From out of the blue, a bolt of lightning struck him and burnt away every stitch of clothing without touching him. I've heard of seams being burnt away, but not all at once! (See Hart's Giant Book of Fascinating Facts, p. 148.)

"From the same source there is an undated account of lightning striking near a flock of sheep grazing near Lapleux, France. All the black sheep in the flock were killed instantly, but not one of the white sheep was so much as touched. This sort of thing carries selectivity of targets a bit too far."

Perhaps, but... In our issue of July 1972 we reported on a Shenandoah National Park Ranger, Roy C. Sullivan, who had been struck by lightning no less than four times and lived to tell about it. He's been hit again.

The Washington Star-News (Washington, D.C.) of the 27th August 1973, reports that Sullivan was struck for the fifth time on the 7th August of this year. They quote him as saying, "I had had a dream that I was going to be struck again this year and after that I had been dodging every storm that came near me". He added that every time he saw a storm gathering, he leaped in his car and headed in the opposite direction at top speed, but miscalculated in August 7th. "It struck me right on the head, set my hair on fire and went down my left arm and left leg, knocked my left shoe off, but didn't untie the lace or cut it, then crossed over to my right leg below the knee and went into the ground." This time he was away from work for seventeen days.

Mr. Sullivan is no longer afraid of being struck. He states that he has had another dream. "That was the last one. I know exactly why it happened—it was all for good purposes." However, he will not elaborate on this, saying simply, "That's between God and me, and nobody but us will ever know". A 'final' answer but not a helpful one. Only time will tell whether he is correct. For his sake, we hope so.

LONDON FOR DARKNESSES?

One of our English subscribers sends the following account to be added to our catalogue of "unnatural darkneses".

"This happened to me, circa Spring 1942, when I was working for the war time Government in an obscure department as typist. The building where I worked was near Westminster Abbey and the Houses of Parliament and the bus that took me homewards went up Whitehall, the seat of the Government where all the civil servants and war officers were situated.

"One day, about 4 p.m., I got on my bus to go home, and it was a clear, rather dull day. But as the bus turned past the Houses of Parliament and up towards Whitehall, the whole atmosphere darkened and we drove into a perfect fog; dark air billowed round the bus and the conductor had to put on the lights, and we looked at each other startled. (I don't remember anyone else on the bus — but do remember the look between the conductor and myself). We drove up Whitehall without a stop — it is quite a short street — and then came onto Trafalgar Square, and lo! the fog lifted and the streets were clear again. Fog over Whitehall! yes, literally true. I never saw this mentioned by anyone... I seem to remember the lights being on in the offices in Whitehall as we went through, but not elsewhere."

Again, we would ask that any members who might have further information on this incident get in touch with us; or if you have other examples, we will be happy to have them.

PRE-EARTHQUAKE PHENOMENA

One of the things that interested Charles Fort was the occurrence of various phenomena preceding earthquakes, almost invariably dismissed by the 'experts' as being 'unrelated' to the quake. Despite this, the common man has continued to report such things as glows in the skies, odd dark clouds, etc. This has now become almost 'respectable' because of the near necessity for finding some way to predict earthquakes so that at least some precautions can be taken or arrangements made to provide relief for the victims afterwards.

A recent earthquake in Mexico was preceded by flashing red glows, similar to "heat lightning", and sounds of thunder in a clear blue sky. White flashes were seen after the quake. Also, Soviet scientists studying the 1966 earthquake that wrecked Tashkent have announced that the sky there did glow several hours before the quake, and that the cause was a "redistribution of electric charges in the earth-atmosphere system". Electron concentrations were measured at stations at Alma Ata and Tashkent the night of the quake; the ionosphere over Alma Ata was found to be "calm", but over Tashkent "a silent storm of electrons" broke out several hours before the quake, reached its peak before the first tremor, and then subsided.

We have reported before on the fact that animals show every evidence of sensing an impending earthquake, despite a lack of obvious warning signals, and

have speculated that some electromagnetic disturbance may be at the root of this. (Probably Man also has the necessary 'receptors' but these are either hypertrophied or we have trained ourselves to ignore the signals. If you read reports by persons who have had some type of "psychic" experience, you will often find a statement to the effect that the episode frightened the person so much that he or she does not want anything like that to happen again and will deliberately try to 'block' such abilities. This could be true of more 'physical' predictions as well. It would seem that few premonitions have to do with pleasant events.) Some very bizarre and measurable phenomena occurred before the earthquake that hit Hawaii Island on the 26th April 1973; so bizarre that one scientist said, "It's too much like Buck Rogers—we have no explanation for it yet".

About an hour before the earthquake struck Hilo (on Hawaii Island, some 200 miles southeast of Oahu) the radiowave-reflecting layer of the ionosphere some 50 miles up "suddenly disappeared—that is, for some odd reason, the layer did not reflect radiowaves sent up from the ground". And the Navy's "Omega Navigational System", producing longwave-length radio signals to guide ships far at sea, "began drifting and not making any sense". "Omega" hit its maximum drift just about the time the quake occurred and then began to recover; and the ionosphere again began reflecting radiowaves immediately after the quake.

Discovery that the ionosphere was 'missing' was a serendipitous outcome of studies set up to try to provide an early-warning system for tsunamis (so-called tidal waves). Major tsunamis are commonly preceded by a particular type of earthquake shock wave—called Rayleigh waves—which are detectable in the atmosphere as well as in the ground, and it

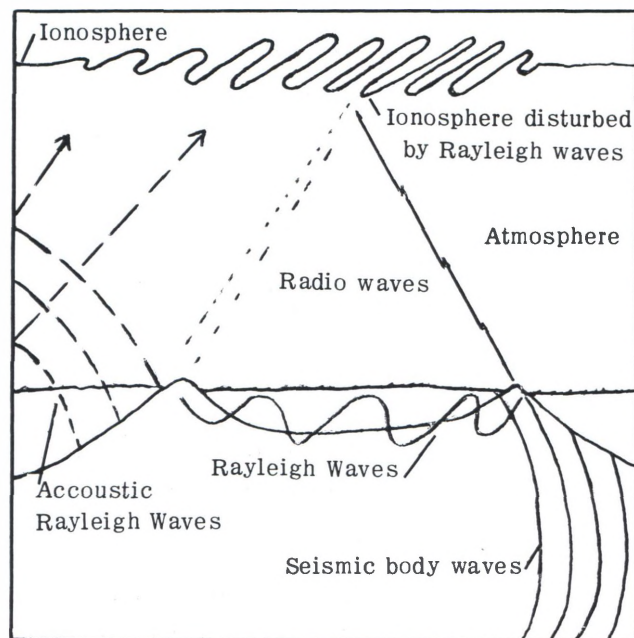

Redrawn from AP Diagram

was these Rayleigh waves that the observatory at Oahu, which discovered the 'missing ionosphere', was looking for. They can be detected by special radio signals, and it was these that failed to return from the ionosphere.

This Hawaiian earthquake was also abnormal in that tremors at Oahu continued to be recorded for two hours instead of the usual 30 to 45 minutes. The reason for this is unknown. To date, so far as we know, there have been no published speculations on just what happened here or why. The widespread reports of flashing lights in the sky prior to earthquakes may indicate that "electron storms" are a common event in conjunction with earthquakes. In the articles available to us there is no mention of such before the Hawaiian quake but, obviously,

something went 'wrong' with the ionosphere. Equally, it would appear that the ionosphere, though disturbed over Tashkent, did not disappear before or during that 1966 earthquake. Nevertheless, there now seems to be no question that there are unusual atmospheric concomitants to earthquakes, and we would suggest that the scientists should pay more attention to reports from the "benighted natives" of bizarre events preceding or following earthquakes. The basic mechanism governing the occurrence of quakes is fairly well understood, and their destructive powers well known; what we need now is a thorough study of the less visible consequences. Flashing lights are far from being the only unusual phenomena that have been reported before earthquakes. The others tend to be even "worse".

VII. BIOLOGY

ABSMAL AFFAIRS IN PENNSYLVANIA AND ELSEWHERE

by Allen V. Noe

Editor's Note: This issue of Pursuit was deliberately held up in order to bring you this report on the extraordinary events in Pennsylvania. As of the time of writing (mid-October), there have been no new reports for about two and a half weeks and it seems that the creatures have withdrawn from the area for the time being. Publicity on this has been kept to a minimum, both to avoid panic locally (and we must emphasize that there are no reports of humans having been molested in any way, even when they have taken pot shots at the 'monsters') and to avert an influx of trigger-happy monster-hunters who too often damage private property and show a tendency to take pot shots at anything that moves. We would ask our members not to go barging off to Pennsylvania where they will probably only cause us trouble at this point. There is no current activity there in any case. We are in touch with investigators there and are prepared to take any necessary action.

In August of this year, I took my wife and Number Two son on a trip to Arkansas, Oklahoma, and Texas, primarily to visit relatives but also to check on Unexplaineds along the way. While visiting a friend in Little Rock, Arkansas, I first heard of sightings of large, hairy creatures in the vicinity of Pine Bluff, and we therefore made a detour to that city. The Sheriff's Office there had reports from two out-of-state motorists that they had seen a large, hairy something standing upright on the highway north of Pine Bluff. When the motorists approached it, the creature dropped to all fours and took off into the woods in a hurry. Since this was consistent with a bear's behaviour, neither the Sheriff nor I considered that this was anything other than a bear, but in the light of more recent developments, it is more than possible that it was not a bear.

Others had also reported sightings, but there were insufficient details to warrant the assumption that a bipedal animal was involved. A newspaper clipping just received, however, reported that three boys riding motorcycles near Pine Bluff had seen a large, hairy, ape-like beast cross the road, walking upright and carrying a blonde girl in its arms! We are told that no blondes are known to be missing, and this story remains for the moment "unconfirmed", but we are still checking on it.

While in Pine Bluff, I telephoned a contact in Texarkana to inquire about the status of the "Fouke Monster" (first reported on in our issue of October 1971). I was told that the creature had not been seen in the area for some time but that there had been reports of a similar creature decimating the chicken population in northern Louisiana. (I had visited Fouke, Arkansas, in October 1972, at which time Glenn Zorn, who had grown up on his grandfather's farm near Fouke in the area where all the footprints were found, was my guide. I obtained a cast of the creature's footprint, saw the bed made of brush, grass and leaves where it had been sleeping, and interviewed witnesses who had seen it crossing a nearby road several times.)

A letter, dated the 5th October 1973, from the Commerce Journal of Commerce, Texas, reported two sightings of another monster in the South Sulphur River bottoms near Peerless, Texas. One person reportedly has photos of some tracks, and we have taken steps to obtain copies of these. Also, Johnny Newcomb, a SITU member from Oklahoma City, reported a large, hairy creature which had been seen near Hobart, Oklahoma, but noted that the available information is insufficient to permit a definite statement on the nature of the beast.

I returned home on the 23rd August, believing—quite erroneously—that that was that for the summer. As I caught up with my reading I came across an AP release dated the 31st August, which reported "Bigfoot" sightings in Westmoreland County,

Pennsylvania. The release suggested considerable reluctance on the part of Greensburg (the county seat) officials to talk about this, so I contacted Stan Gordon, Director of the Westmoreland County UFO Study Group (WCUFOSG) and now one of our members, who was stated to be investigating the matter. He told us of what must be one of the greatest known concentrations of sightings of huge hairy bipeds in history.

There had been frequent sightings, starting in June and reaching peak during the hot and humid weather in August, at which time Stan had as many

Pittsburgh for analysis but that no reports were forthcoming. Stan Gordon therefore went with me to the Museum and we retrieved the material, which I brought back to SITU headquarters. The hair and feces, together with additional specimens gathered by me on a subsequent trip, were sent to Frederick Ulmer, formerly Curator of Mammals at the Philadelphia Zoo but now retired, for examination; and other specimens which I will discuss below, were sent to Professor George Agogino of the Paleontological Institute of the University of Eastern New Mexico. As of the 12th October 1973, the hairs have



Map of Westmoreland County, Pennsylvania, showing locations of major sightings and areas of concentration (circled on the map).

as five people to man telephones and two-way radio communications with the members of his group who were attempting to visit and question all those who had reported seeing the creatures and to look for footprints and other evidence. For about two and a half weeks they got little or no sleep.

Accompanied by my wife Polly, an avid monster hunter, and by Robert E. Jones, an enthusiastic new member of SITU, I drove to Greensburg on the 6th September, returning home on the 10th. We had an opportunity to interview several persons who had seen the 'monsters' and to respond to some telephone reports. Further, we learned that samples of hair and feces and a cast of an almost certainly authentic footprint had been taken to the Carnegie Museum in

not been identified as those of any known species, but no definitive report is expected for some time. The identification of hairs is a much more complicated business than most people realize.

I returned to Greensburg on the 21st September and stayed until the 4th October, both to be on hand to help to investigate current reports and to organize the reports already on hand. We now have over 6,000 feet of tape-recorded (at 1 7/8 ips) statements of eye-witnesses and on-site searches for footprints, etc. We also prepared a card index (on 3 x 5 cards) with condensed accounts of approximately 100 sightings, many by more than one person, thus constituting reports of some 150-175 witnesses. Questionable reports and known hoaxes were not included here.

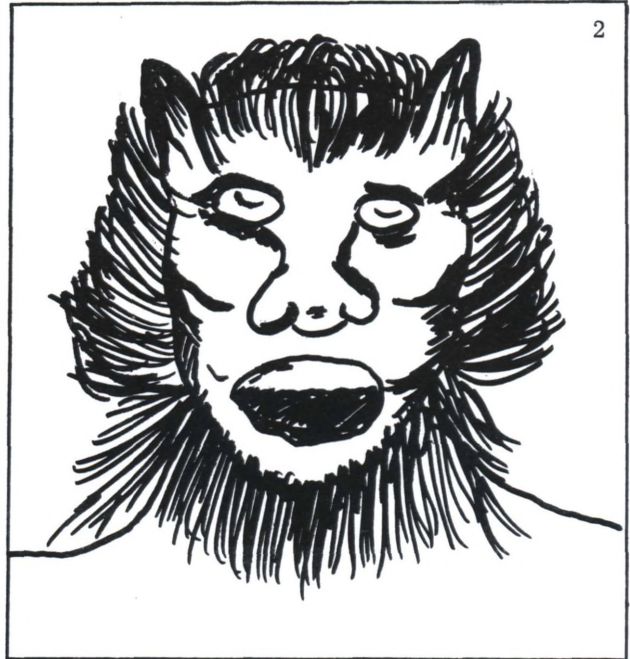

Drawings by Bob McCurry of the Westmoreland County U.F.O. Study Group, redrawn for Pursuit. Reproduced with permission from WCUFOSG.

1) Seen at Luxor, Pa., on the 26th August 1973 at 5:00 p.m. The absence of a neck is typical of ABSM reports though the face would seem to be far too "human".

2) Seen at Latrobe, Pa., in September (exact date not legible). This is most curious, having a very catlike appearance. The body, not reproduced here, is more or less typically "absmal" but shows definite hips, not usually reported of ABSMs; and the hands are turned backward as in Erb's paralysis, otherwise known as "porter's tip hand".

3) Seen at Beech Hills, near Jeannette, Pa., on the 27th August 1973 at 2:30 p.m. The very prominent fangs shown here have, so far as we know, never been reported of an 'ordinary' ABSM.

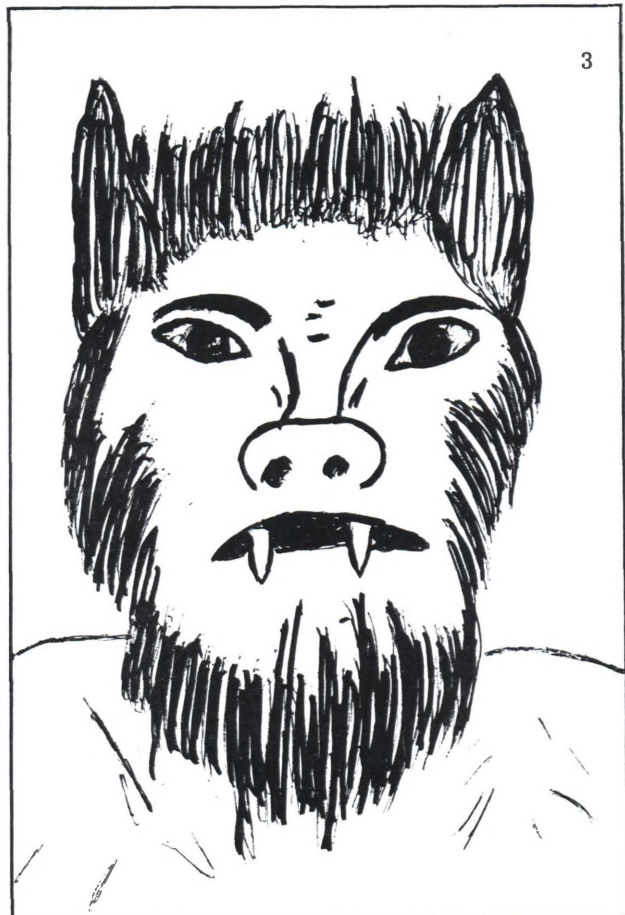

(One 18" foot print, for example, was a very crude fake, though it received perhaps more publicity than any other prints found.)

The usual description of the creatures was as follows: 8 to 9 feet tall, covered with dark hair; walking upright on two feet; having a smell like "sulphur", "rotten eggs", or "rotten meat"; with long legs (a 50- to 57-inch stride when walking); long arms reaching below the knees; large orange-red eyes that glowed in the faintest light; a flat, broad nose; "pointed" ears; a large mouth with a long white 'fang' at each corner; and a gait that seemed awkward until the creature started to run — witnesses stated that they doubted that a deer could outrun it. Young ones were also reported. A "family group" was seen on a golf course one night by five persons, who

estimated their heights as approximately 4 feet, 6 feet, and 8-9 feet.

It is impossible to ascertain how many of these 'monsters' were in the area. As many as three were seen at a time, and nearly simultaneous reports were received from widely separated areas, including at least three adjoining counties. The map shows the areas of greatest activity (circled areas). Most were seen at night: crossing roads; along railroad tracks; in people's dooryards; looking through second-story windows (!); on porches; in one instance, on the roof (a long arm with a "three-clawed hand" was reportedly seen reaching down); and frequently near abandoned coal mines or caves. There were, however, a few daylight sightings, usually early in the morning or late in the afternoon.

A few representative cases are related here, names being used only when we have specific written permission.

At 6:35 p.m. on the 1st September 1973, a woman from Whitney, Pa., was in the Youngstown, Pa., cemetery placing flowers on her mother's grave. Her baby girl, a toddler, went toward the edge of the woods (about 30 feet away). The mother smelled an overpowering rotten odor and heard her baby start to cry. She turned round and saw a large, hairy, ape-like creature moving slowly toward the child. She grabbed her, just a few feet from the monster, ran to her car, and drove to her father's house (about five miles away) to call the police. An hour later the creature (she believes it was the same one) showed up at the father's house; her brother and sister saw it standing at the corner of the house.

On the 2nd September, Mr. and Mrs. Chester Yothers of Whitney, Pa., were sitting with friends on the screened front porch of their trailerhome. Mr. Yothers, a retired coal miner, told me that he had

believed the whole thing was a hoax and that he would believe it was real when he saw it. He even called out, "Hey, Bigfoot, come on in here; I want to see you." They all laughed about it; the company left, and the Yothers went to bed. About 4:30 a.m. Mr. Yother heard a noise outside and thought that someone was trying to break into his garage. He pulled back the window curtain, looked outside, shook his head, then looked again. The "monster" was standing about five feet away, looking at the house next door where eight small children live, who usually sleep on the front porch on hot nights. He shook his wife, asked her if she was awake. He told her not to be scared, but if she wanted to see "Bigfoot" she should look out the window, because he was standing right outside! She did so, and they decided to call the police. As they made their way through the trailer to the phone in the living room, they looked out the back door and noted that the creature was still standing there looking at the house next door. After calling the police, they looked again but he was gone. Two police cars arrived soon afterward, and they found wet footprints on the rear concrete terrace; these were also visible in the wet grass. Older footprints were discovered in flowerbeds at a corner of the trailer. Mr. Yothers is known in the area as an absolutely honest man, and his experience made "believers" of a lot of local residents. I talked to one of the State Policemen who investigated this incident, and he stated that he was convinced that the Yothers had seen exactly what they described. The Yothers, incidentally, were afraid to stay at their trailer, and visited relatives for a few days until the shock of their experience had faded somewhat.

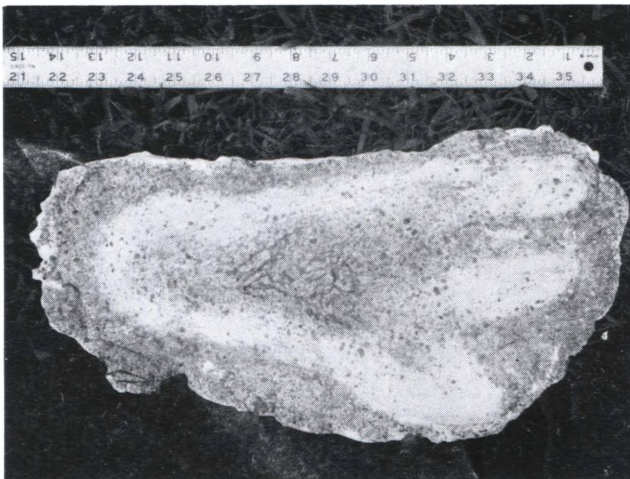

Cast of the 'standard' three-toed print found in Westmoreland County. The print has been outlined with a very thin layer of plaster to make the contour easier to see. The print does not match any known type of foot.

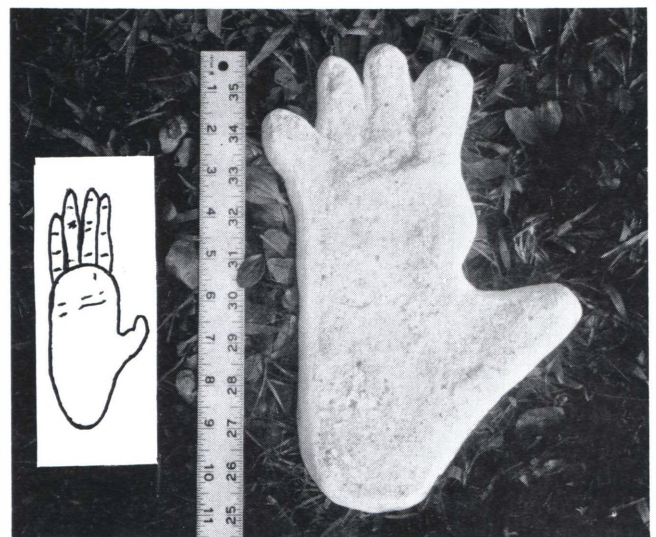

Cast of the ape-like print found in the Verona-Penn Hills area of Pennsylvania, together with the outline of an orangutan's footprint. Notice the shortness of the 'front' toes and the apparent lack of any joint in the great toe.

Although generally dogs were reported to react to these creatures with signs of extreme fright (many dogs seem to have been either mauled or simply carried away by these "Bigfeet"), a woman called from a housing development near Latrobe, Pa., and gave the following account. She was awakened at about 2:00 a.m. by the sound of a dog tearing at something across the street. She went to the window and saw that a dog had a giant creature by the right heel. The creature was tall and built like a very hairy man. Its legs were long, and its arms were so long that it didn't have to bend its knees to beat the dog off. The woman went out into her front yard to get a better look, when the creature broke away and took tremendous leaps going across the yard. She said she could feel the vibration whenever its feet hit the ground. The dog could not catch it, and the woman—more intrepid than most—chased after it in her nightgown to see where it was going. She noticed no odor, and commented that the creature was entirely covered with hair except for the elbows and palms of the hands, which appeared flesh-colored. She did not see the face.

At the edge of Greensburg, near the State Police Barracks and St. Anne's Home for the Aged, both on a hilltop, there is a valley filled with a veritable jungle of briars, thorn trees, brush, and larger trees. On the 21st September at about 2:00 p.m., a group of ten boys ran into the State Police Barracks and told officers that they had been down by the edge of the woods, and saw the head and upper body of a "gorilla-like" creature. They said it was a sort of tan color—which matched patches of hair found on the ground and on tree branches in the area. Two troopers investigated and found footprints. While they were searching the area, the boys saw the creature again, moving deeper into the woods. Stan Gordon, another member of his group, and I visited the site, guided by three of the boys. We found footprints deeply impressed in soft earth in a grassy spot, and also several fecal specimens. Pulling the long grass from the impressions, we found the dimensions of the prints to be about 14 inches long and 7½ inches wide across the toe portion. The individual toe prints could not be distinguished in the matted grass. We also found some tan-colored hair.

On Monday, the 24th September, at about 2:30 p.m. two boys were in the woods in the same area, and reported that they saw a large, "gorilla-like" creature lying asleep on some old grass clippings which had been dumped there by St. Anne's maintenance personnel. The boys were very frightened and ran up the hill to get a man and his son to come down. When they returned, the creature had gone. They described the creature in great detail to the WCUFOSG artist, Bob McCurry, who made a sketch under their direction. That same evening at about 5:00 p.m., a newsboy was delivering papers near the St. Anne's Home, when he looked toward a hill on the other side of the wooded valley and saw a tall, tan-colored creature which walked with a stooped posture "like it was drunk".

All the reports are generally similar except for three in which someone shot—or shot at—one of the creatures, never (so far as can be ascertained) with any particular effect. No specimen was acquired for scientific study, and no photographs were obtained. We did get four 'clots' of what was thought to be blood from one of the creatures, shot (at?) with a .35 calibre rifle. One sample was sent to a local police laboratory, the rest to Professor Agogino in New Mexico. They proved not to be blood, but further tests to determine just what they are, are being carried out by experts chosen by Professor Agogino. These may take some time but the results, together with the report on the hairs and feces will be published when available.

Just when we had decided that the overall picture presented above was reasonably accurate, we were considerably jolted by two incidents. The first was initially reported to us by Channel 11 TV at Pittsburgh. We immediately contacted the party mentioned, who directed us to the vicinity of Verona, Pa., in the Penn Hills area. There is here an extremely wild 100-acre tract of tangled trees, brush, berry and grape vines, etc., in the midst of a built-up area. Some of the local boys were riding their motorbikes through some trails on Saturday, the 22nd September, when they heard something large in the woods, moving through the brush and breaking tree branches. They rode home in panic but returned later the same evening. They found fresh tracks in the area but none had casting materials. That night there was heavy rain, and the next day the father of one of the boys—a Mr. Baird, who is a bank employee—went to the area but found the tracks washed out. He went deeper into the woods, found some fresh tracks, and made a cast of the best one he could find. So help me, it was a pongid-type (i.e. ape-type) track, 11 inches long, 5 inches across the four-toed portion, and 7 inches across the great toe. One of the boys had reported seeing a monkey-like creature in the woods the summer before, but everyone laughed at him. What he said he saw was something in the trees with long legs and arms and a tail. Apes, of course, do not have tails.

We had not 'recovered' from this when a WCUFO-SG member from an adjoining county called concerning a most extraordinary case. This had occurred at about 9:30 p.m. on the 27th September, when two girls encountered a seven- or eight-foot, white hairy creature carrying a luminescent sphere in its hand. Both girls were white with shock when they returned to the house. The father of one of the girls (the property owner) was said by his daughter to have gone into the woods for over an hour, but when interviewed later, he denied having gone into the woods, stated that there were some things that shouldn't be discussed and that he did not want anyone tramping about in his woods. After the incident, it was reported that a "plane" was seen shining a bright light down into the woods. (The man appeared to have experienced a personality change following this whole

BEAVER
Co.

experience, and the possibility that he may be one type of UFO 'contactee' must be borne in mind.) Further reports from this area note the finding of several sheep with "their intestines ripped out" and the body of a dog with a "hole in its skull".

Apparently there was a considerable UFO activity in the Westmoreland County area, but there is really no evidence, let alone proof, of any connection between UFOs and the 'monsters', with the possible exception of the last case reported here, and even in this instance the evidence is purely circumstantial. Dr. Douth, Curator Emeritus of the Carnegie Museum in Pittsburgh, when told of the monster sightings, speculated that they seemed to bear out the Amerind legend of the Wendigo which howled and prowled round the tepees at night. In the circumstances this may be as good an explanation as any!

The tracks found are none of them truly hominid or pongid. Although the Fouke Monster had/has three toes, the footprint is quite different from the Westmoreland County prints which show three broad and rather widely separated toes rather than three thinnish ones directed straight forward. Nor is the "ape" print "right". The toes (or fingers) are much too short if one compares them with, for example, an orangutan's print (shown, not to scale, with the "ape" print). In fact, the various footprints resemble nothing known to us, but they are themselves facts, and physical ones at that. Taken with the hair and other specimens, it seems that the monsters must be physical beings, wherever they come from. There are those who have suggested that ABSMs (abominable snowpersons generally) may be "projections", i.e. non-material entities, and that this explains why none has been caught. Certainly they are exasperatingly elusive and, apparently, "immune" to bullet holes!

The Bigfoot, Sasquatch, or what you will, of our Northwest, Canada, and elsewhere, has a hominid foot, as proved by casts of genuine prints, and though parts of the description of the Westmoreland monsters fits the 'ordinary' Sasquatch description, some details do not. So far as we know, the "pricked" ears are not reported of the Sasquatch, though it is quite possible that this is actually a tuft of hair and not actually a pointed ear. The sketches drawn by Bob McCurry of WCUFOSG under the direction of witnesses are somewhat dismaying. (The copies given us were not reproducible and have been redrawn for Pursuit.) No. 1 reminds us of Charlton Heston playing some dismayed prophet; No. 2 has a curiously catlike look about it; and No. 3 looks like something out of Frankenstein Meets the Wolfman. Please understand that this is not meant as any

reflection on Mr. McCurry's ability; I know he has done his utmost to duplicate the witnesses' recollection of what they saw and has done an excellent job of it. This leaves us with two possibilities: either the creatures did look this way, or the witnesses tended to see what they 'expected' to see, based on past experience with horror films and such, and subconsciously coloured their descriptions of the face. Since we "weren't there", it is impossible to be certain on this point, but we are unnerved, to put it mildly, to think that there might be five types wandering about in western Pennsylvania. Viewing conditions were usually not the best possible, and it seems best to withhold judgment on the drawings and go by the general description given. The "ape" and the sphere-carrying creature do seem to form totally separate categories and probably should be kept separate from the other reports.

Just why there should have been this "population explosion" among ABSMs in western Pennsylvania and where they came from is, of course, unknown, though there are a number of factors which may be pertinent. We learned that reports actually go back a number of years —witnesses were scoffed at and ridiculed and soon learned to keep their mouths shut—so we must assume that these ABSMs have been resident in that area for some time. In very recent years there has been initiated a very active program for filling in old strip mines and closing off old mine shafts which the ABSMs may have used as shelters. Also, many small farmers have simply given up their farms, with resulting elimination of salt blocks in pastures and the return of considerable acreage to its natural wild state. All this may have combined to produce this "explosion". We will be studying all the collected material most carefully for both general information and specific patterns of behaviour, appearance, etc., and as finances permit, will make further "expeditions" to the area if circumstances require it. We as a Society, and Science generally, owe a great debt to Stan Gordon and the Westmoreland County UFO Study Group for the tremendous job they have done, without compensation, in recording for study all possible details of of this extraordinary series of events.

There are an increasing number of reports of ABSM-type 'monsters' from many parts of this country, and the cooperation of all our members is solicited in this effort. Please report to us any such incidents in your area, no matter how unlikely such reports may seem from the standpoint of sightings near large cities and other "built-up" areas. We will do our best to investigate these reports.

"Researchers Get Windfall"

A Reuters report datelined Cranfield, England, 29 June 1973, noted that "Researchers studying the effect of wind on buildings got some dramatic findings Wednesday when they discovered that a freak wind during the previous night had blown the roof off their research station here."

VIII. ANTHROPOLOGY

NOT THE SALZBURG STEEL CUBE, BUT AN IRON OBJECT FROM WOLFSEGG

by Hubert Malthaner (translated by H. Friedrich)

An increasing number of books today advocate the theory that there existed, in remote so-called prehistoric times, civilizations on this earth far surpassing our own in technological development. It is alleged that these civilizations were annihilated by great natural catastrophes which might, perhaps, have been triggered by global warfare employing 'super-weapons' of some type.

As irrefutable evidence of such prehistoric super-civilizations the authors of several such books mention a steel cube found in 1885 in a block of coal in Austria. Although none of these authors apparently was able to inspect this object personally, they all wrote about it, freely adding details. For an extended period of years the famous Salzburg steel cube was thought to be lost. But since the strange object has now been rediscovered, so to speak, it seems proper to follow its traces through the literature, beginning with the first reports and ending with the facts brought to light by the latest photographs and analysis.

Charles Fort, that indefatigable collector of newspaper and journal articles about strange and enigmatic occurrences, cites four reports from scientific journals about 'our' object in his Book of the Damned, published in 1919. Two of them (Comptes Rendus, 103-702, and Science Gossip, 1887-58) I mention here only for the sake of completeness because I have been unable up to now to locate them. Fort says that in Comptes Rendus a full account of this object is given. Perhaps one of our members may succeed in locating a copy. The third report mentioned by Fort is Nature, 35th year, issue of November 11, 1886. This report, on page 36, reads as follows:

"At a recent meeting of the Nieder-rheinische Gesellschaft für Natur- und Heilkunde at Bonn, Dr. Gurlt described a fossil meteorite found in a block of Tertiary coal, and now in the Salzburg Museum. He said it belonged to the group of meteoric irons, and was taken from a block of coal about to be used in a manufactory in Lower Austria. It was examined by various specialists, who assigned different origins to

it. Some believed it to be a meteorite; others, an artificial production; others, again, thought it was a meteorite modified by the hand of man. Dr. Gurlt, however, came to the conclusion, after a careful examination, that there is no ground for believing in the intervention of any human agency. In form, the mass is almost a cube, two opposite faces being rounded, and the four others being made smaller by these roundings. A deep incision runs all round the cube. The faces and the incision bear such characteristic traces of meteoric iron as to exclude the notion of the mass being the work of man. The iron is covered with a thin layer of oxide: it is 67mm. high, 67 mm. broad, and 47 mm. at the thickest part. It weighs 785 grammes, and its specific gravity is 7.75; it is as hard as steel, and it contains, as is generally the case, besides carbon, a small quantity of nickel. A quantitative analysis has not yet been made. This meteorite resembles the celebrated meteoric masses of Saint Catherine in Brazil and Braunau in Bohemia, discovered in 1847, but is much older, and belongs to the Tertiary epoch."

Fort's fourth source is given as L'Astronomie, 1887-114, but this is not correct; it is page 463, and the year is 1886, not 1887. There one finds, under the headline "Une meteorite fossile", essentially the same text as in Nature. But, in addition to the above report, the French text reports that "the object was discovered in 1885 in a big block of coal in the steel factory of Mr. Isidor Braun at Schöndorf near Vöcklabruck, Lower Austria. The block of coal originated from the coal pit at Wolfsegg near Schwannstadt."

Thus Fort's source material from scientific journals of the last century. There are some minor errors in these articles: for instance, Vöcklabruck is a small town in Upper, not Lower, Austria; and the object has never been in any Salzburg museum. Charles Fort, too, I regret to say, is guilty of incorrect reporting, for he states of the object, "It's a cube" (p. 132, Collected Works). But later on, reports on the strange object become even more unreliable. In Science et Vie no. 516/September 1960, Georges Ketman writes (in his article "Les cartes bouleversantes de Piri Reis, une carte de l'Antarctique vieille 10.000 ans", p. 89):

"Quelle est, par exemple, l'origine de ce parallé-

IMPORTANT NOTICE

Our member #761 has brought to our attention a 'review' in the New York Times of the 1st August 1973, of a program produced by an organization calling itself "SITU (an acronym for Society for Investigation of Things Unnameable)...a loose alliance of dancers, film makers, musicians and artists who create multimedia events, and have been doing it for two years here and in Europe". We very much doubt that this group's choice of name and acronym is accidental and, although "imitation is the sincerest form of flattery", we must put on record most strongly that that group is in no way connected with our Society or its founder, the late Ivan T. Sanderson, and any suggestion to the contrary is entirely false.

épipède parfaitement régulier, composé d'acier, qui est actuellement exposée au Musée de Salzbourg?" [What is, for example, the origin of this perfectly regular parallelepiped,* composed of steel, which is actually on view at the Salzburg Museum?]

The three words "parallélépipède, parfaitement régulier", apparently stemming from Ketman's imagination, were the cause of much confusion and premature hopes. As we shall soon discover, there is nothing at all in Ketman's description that can be justified by the actual appearance of the object. And two years later the Russian author Alexander Kasanzew in Die Sowjetunion Heute (a German language Soviet information monthly; Cologne 1962, no. 1-7) published a series of articles about contacts with superior civilizations arriving on earth from space.† According to him, the object is "A cube with parallel and smooth surfaces of 67 x 67 x 47 millimeters with a weight of 785 grams made of worked steel". All of this, apparently stemming from Ketman and Kasanzew, found its way into articles and finally into books by best-selling authors such as Charroux and von Daniken. The confusion became even worse when someone "translated" Ketman's "parallelepiped" a bit too carelessly and thus transformed the Wolfsegg iron object into "parallel pipes"! For instance, in Newsletter (edited by C. Honey, Anaheim, California), of January 1963, and thereafter in UFO publications around the world, readers found the information that "The Russian archaeologist Alexander Kasantsev is going to Salzburg with the intention of analysing parallel pipes of polished steel embedded in the deep veins of an Austrian coal mine and dating 30,000 years before our era."

With this lengthy but necessary prologue out of the way, we now turn to the facts.

In the autumn of 1885 in the iron foundry of Isidor Braun's sons at Schöndorf near Vöcklabruck in Upper Austria a workman was smashing big blocks of coal which had arrived from the coal pit at Wolfsegg as fuel for heating a smelter. During the course of this work he found the now famous object, a find that was then widely noticed because of its form and circumstance of discovery. In 1886 a mining engineer, Dr. Adolf Gurlt, gave a lecture for the Naturhistorischer Verein (Natural History Society) at Bonn concerning his investigations of the object. He told the audience that some specialists felt that, because of its roughly square form, the metal object might have been worked on, but that in his opinion it was a fossil iron

meteorite because of a thin film of oxide on the surfaces and the strange, hollow marks thereon. The report was printed in Verhandlungen des Naturhistorischen Vereins der preussischen Rheinlande, Verlag Max Cohen & Sohn, Bonn, 1886, page 188. This was the first report on the object and the source of all later reports. Translated into English, the most pertinent section reads as follows:

"Dr. Gurlt submitted a strange iron meteorite, so-called Holosiderite,... which was found in tertiary brown coal. It is in the possession of the municipal Carolino-Augusteum Museum at Salzburg and was presented to it by Messrs. Isidor Braun Sons at Schöndorf near Vöcklabruck in Upper Austria. The object was discovered at the steel and file factory of this firm, accidentally...in 1885 by a workman when he smashed a block of brown coal...". The essential contents of this report were those included in Nature and L'Astronomie. Dr. Gurlt further told his audience that a polished and etched surface showed no Widmanstätten pattern. He thought that the shape of the iron object was caused by the strong heat plus the rotation of the "meteorite" during its flight through the atmosphere. Dr. Gurlt also stated, erroneously, that the object was kept in the Carolino-Augusteum Museum at Salzburg, but the object was in fact never at Salzburg. In my opinion, Dr. Gurlt was confused by the similar-sounding names of two museums, one at Salzburg and the other at Linz. The Francisco-Carolinum Museum at Linz had the object from 1950 to 1958 and I suppose that it had been presented to this museum by its finders [this is not absolutely certain. Ed.]. This museum, which is today the Oberösterreichisches Landesmuseum, has in its possession a plaster copy of the "Wolfsegg Iron". Photographs 1 and 2 are of this plaster copy because they show the uninjured outline of the object.

The original "cube" was in the possession of the Braun family at Vöcklabruck but in 1958 the Wolfsegg Iron was presented to a local museum, the Heimathaus at Vöcklabruck, where it is in the loving custody of Herrn Oberschulrat Robert Bernhart, retired. I was able to inspect it personally this year. Photographs 3 and 4 show the original object in its present form. In my opinion these photographs will eliminate all speculation about a "cube". The only smooth surface occurs where a sample was taken for analysis in Vienna in 1966 (A). One can see there also an older cut and polished surface where, in Dr. Gurlt's time, an unidentified scientific institution (allegedly in Paris) had tried in vain to find Widmanstätten figures (B in photo).

In 1966/67 the object was subjected to the most modern electron-beam microanalysis at the Vienna Naturhistorisches Museum and it was found that the "Wolfsegg Iron" contained no traces of nickel, chromium, or cobalt and that, therefore, it could not be a meteorite. Because the object contains very little manganese, the final opinion of Dr. Kurat of the Naturhistorisches Museum and Dr. R. Grill of the Geologische Bundesanstalt in Vienna is that the

*See Editor's Notes.

† These issues of Die Sowjetunion Heute are now out of print, but Kasanzew's report was reprinted in Die Andere Welt, no. 6, 7/1962 (edited by Hermann Bauer Verlag, D-78 Freiburg.)

object is cast-iron. Dr. Grill believes that such iron objects were used as ballast with primitive mining machinery.

Thus far in examining the iron find from Wolfsegg we have approached truth through several statements in the negative: it is not steel, it is not a cube, and it is not a meteorite. And, though Dr. Gurlt told his audience that the object was found enclosed in tertiary brown coal, there seems at the moment to be no way positively to ascertain such an alleged age for it. And as we have seen, there are several errors in his report. Apparently Dr. Gurlt had neither visited the correct museum nor had he examined the block of brown coal with the intention of finding the cavity or part of a cavity which might have contained the iron object. The man who is today the owner of I. Braun's Sons file factory, Herr Diplomingenieur Martin Braun, does not exclude the possibility that the object was simply found between the coal fragments and might perhaps not have been actually enclosed in any of them. If the object is cast iron and was found in an

iron foundry, it might very well have originated there, and in fact even have been cast there.

It seems to me that this strange object could well have been made in the following way: to cast any object one needs a pattern to make a mould. The rows of hollow marks on the surface of the object show us a possible way in which it might have been manufactured. The pattern was kneaded from some soft material (clay or wax); and the marks are imprints of fingertips. When the periphery of the two opposite faces being rounded was pressed down, the four edges were pressed outward. In this way the "deep incision round the four sides of the cube" could have originated. The pattern was moulded in sand and then the "Iron of Wolfsegg" was cast.

This ends my report on the strange find which has become known around the globe and has posed an enigma to several generations. In my opinion the facts are now clear, though an intriguing residue of unsolved problems still plagues my mind.

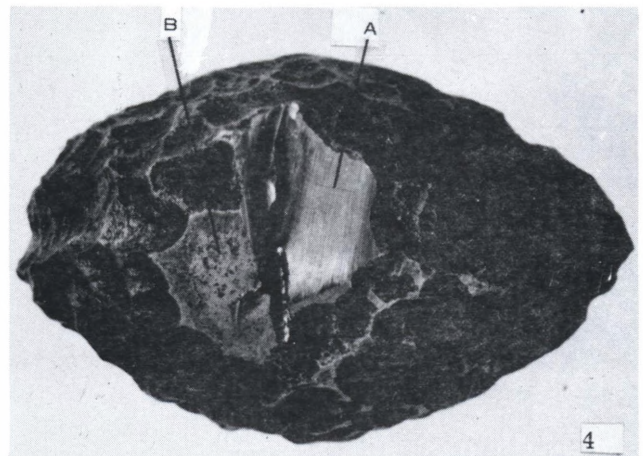
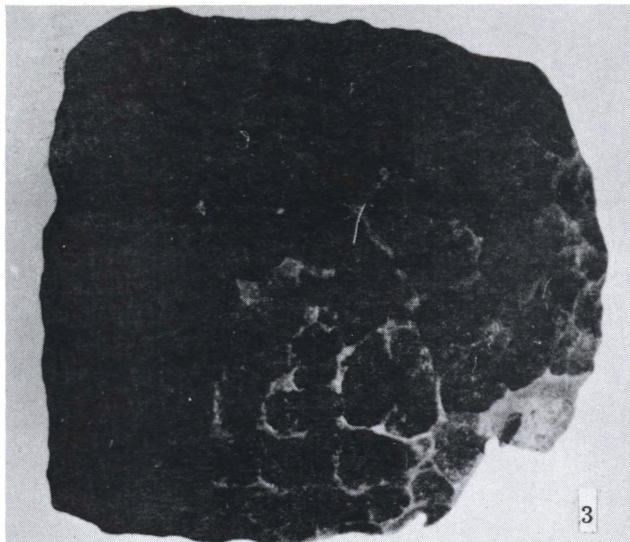
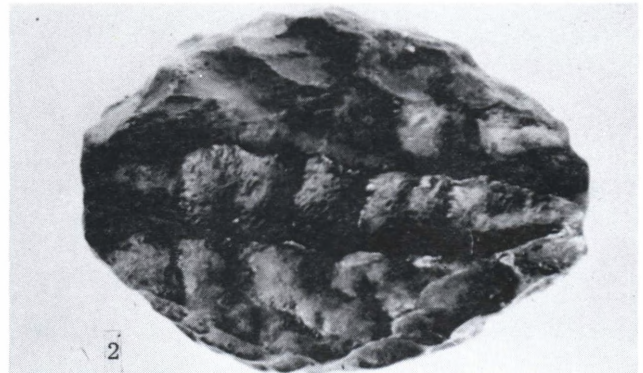
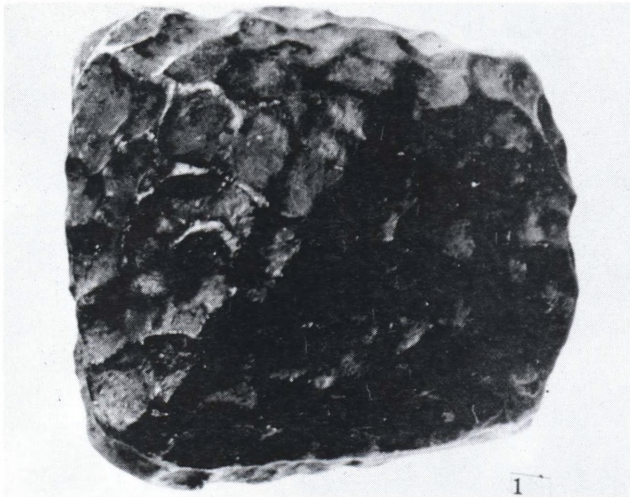

1) Plaster copy, top view, scale 1:1. 2) Same, side view. Both courtesy of the Francisco-Carolinum Museum, Linz, and Herr Malthaner. 3) Original "cube", top view, showing (lower right) the area from which material was taken for analysis; and 4) The same, transverse side view, showing the two cuts made for material for analysis. Courtesy of Herr Malthaner.

Editor's Notes: Messrs. Malthaner and Friedrich are both members of the Society, resident at Munich, Germany, and we are indebted to them for this very full report.

The term "fossil meteorite" is a bit misleading but is presumably used here simply to indicate an old meteorite rather than one that was 'picked up hot off the ground as it were. One of the puzzles of meteorites is the fact that no meteorites have been found in other than recent strata. It is not surprising that the "cube" was thought by some to be a meteorite, since both the coating of iron oxide and the "thumbprints" on the surface, known technically as piezoglyphs, are characteristic of many meteorites. The Widmanstätten pattern is a complicated cross-hatching found on certain types of meteorites, and on no other natural formation, indicating an 8-faced, octahedral crystalline structure.

And the parallelepiped is a 6-sided prism whose faces are parallelograms. Needless to say, it has nothing to do with parallel pipes. It is unfortunate but true that translations are all too often made by lazy or uneducated persons who do not know the subject in any case. Hence the infamous canals of Mars; cannali means lines or striations, not canals.

THE CHINESE PYRAMID

One of the tantalizing stories we have been working on is that of an enormous pyramid in China, far exceeding in size any in Egypt or elsewhere. Our member Ron Dobbins has found for us several of the "initial" reports in the New York Times and a photograph of a pyramid (see below) from a book published in 1902. The NYT article in a UP dispatch, datelined Shanghai, March 27, 1947, and reads in part as follows:

"A giant pyramid in isolated mountains of Shensi Province in western China was reported today by Col. Maurice Sheahan, Far Eastern director for Trans World Airline.

"From the air, Colonel Sheahan said, the pyramid seems to dwarf those of Egypt. He estimated its height at 1,000 feet and its width at the base at 1,500 feet.

"The pyramid, he said, is at the foot of the Tsinling Mountains, about forty miles southwest of Sian, capital of the province. A second pyramid, he continued, appears much smaller.

"The pyramid, Colonel Sheahan went on, is at the far end of a long valley, in an inaccessible part. At the near end, he said, are hundreds of small burial mounds. These can be seen, he said, from the Lung-Hai railroad.

"When I first flew over it I was impressed by its perfect pyramidal form and its great size." Colonel Sheahan said. 'I did not give it thought during the war years partly because it seemed incredible that anything so large could be unknown to the world.

From the air we could see only small footpaths leading to a village at the site of the pyramid.'

"Chinese said that because of the almost complete absence of communications, even trails, in some parts of the West China mountains it was not impossible that a huge pyramid might have been long forgotten...."

The article goes on to note that Dr. James L. Clark of the American Museum of Natural History and Dr. Arthur Upham Pope of the Asia Institute both considered the discovery to be one of "great scientific interest". Dr. Pope, in a letter to the Times dated March 30, 1947, said,

"This raises the further question whether it will not perhaps verify the Chinese tradition of their first, Hsia, dynasty, which it has been fashionable among Western sinologists to question. The next dynasty, the Shang, beginning about 1700 B. C. was long rejected by Western scholars also, until Chinese excavations at An-yang established it beyond further doubt."

The Hsia Dynasty is now, I believe, accepted as real (the latest dates that I have for it are, Traditional - 2205-1766 B. C.; and "scientific" - 1994-1525 B. C.) but it is incredible to me that after the An-yang discoveries there has ever been any doubt that something must have preceded the Shang (or Shang-Yin) Dynasty. This latter is noted for its exquisite bronzes, which certainly were not developed overnight, and suggest a long period of sophisticated technological growth. In any case, Pope speculates that such a pyramid might be a Hsia royal tomb and notes that it would be "one more demonstration of the Asia-wide importance of the cosmic mountain and the astro-celestial cult of which it was a central feature."

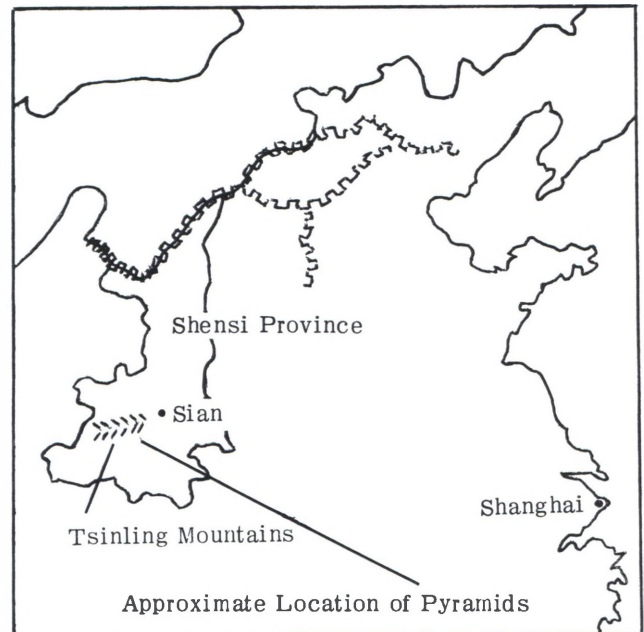

Mr. Dobbins, using other references which are not specifically listed in his letter (we suspect a previous loss in the mails here), says,

"The Great Pyramid of Shensi is interesting—a virtual man-made mountain at 1000 feet high. This dwarfs the so-called "Great Pyramid" at Giza, which is about 470 feet high by 765 feet on the base line. Despite the claims of 'discovery' in '47, the Georgia psychic and healer "Doc" Anderson visited the thing prior to the War & testified to its size. He claimed that it was made of earth or clay, and had a leveled top on which perched the ruins of some kind of temple. Apparently the locals wouldn't let him get a closer look. And, apparently, it is located near the 'field' of smaller pyramids. This group covers an area of some ten square miles—possibly more pyramidal structures here than in all the rest of the world put together! And all oriented on the north-south line, like the Egyptian examples. These Chinese pyramids have not been dated yet, and I wouldn't be too surprised if they are also the oldest findable."

This still leaves us with some problems. Issue #21 of Doubt, edited by Tiffany Thayer, contains the following article:

"The story of Col. Maurice Sheahan was sent out by UP, under a Shanghai date line, 3-28-47 old style. Sheahan had seen 'several years ago' a pyramid in China bigger than any in Egypt. He had taken a photo from his plane. He had the photo at his home in Ontario, Calif. Ontario is in San Bernardino County, near LA [Los Angeles].

"The next day, the LA Daily News printed a four-column photo, 'First Picture of Great Chinese Pyramid.' The photo credit was to 'Acme Telephoto'. Mr. Sheahan is not mentioned, neither is the picture dated, but if this is the photo taken by Sheahan 'several years ago', why was it necessary to send it by wire from Ontario [California] to LA, and since when has a village the size of Ontario had the facilities to send 'telephotos'?"

"Two days later, 3-31-47, AP sent its papers a story under a Nanking dateline, stating that 'the Provincial government had announced, following an investigation, that the reported discovery of a giant pyramid in Shensi province proved to be groundless.'"

This last may have been 'political', i.e. a move designed to discourage foreign investigators or simply to provide an excuse for saying No to anyone requesting permission to visit the area. On the other hand, the photograph reproduced here is said to show one of the smaller pyramids but contains nothing that makes it possible to determine its actual size. Or—let's be frank—its location. Still, the photograph is itself a fact, and unless one wishes to call both Col. Sheahan and "Doc" Anderson liars, it is necessary to accept the photograph as evidence that there are enormous pyramids in China.

The largest artificial mound in western Europe is Silbury Hill near Avebury in England. It is 'only' 130 feet high with a base covering more than five acres; small compared with the Great Pyramid but still representing an enormous amount of labour, and, because of its earthen construction, closer to the

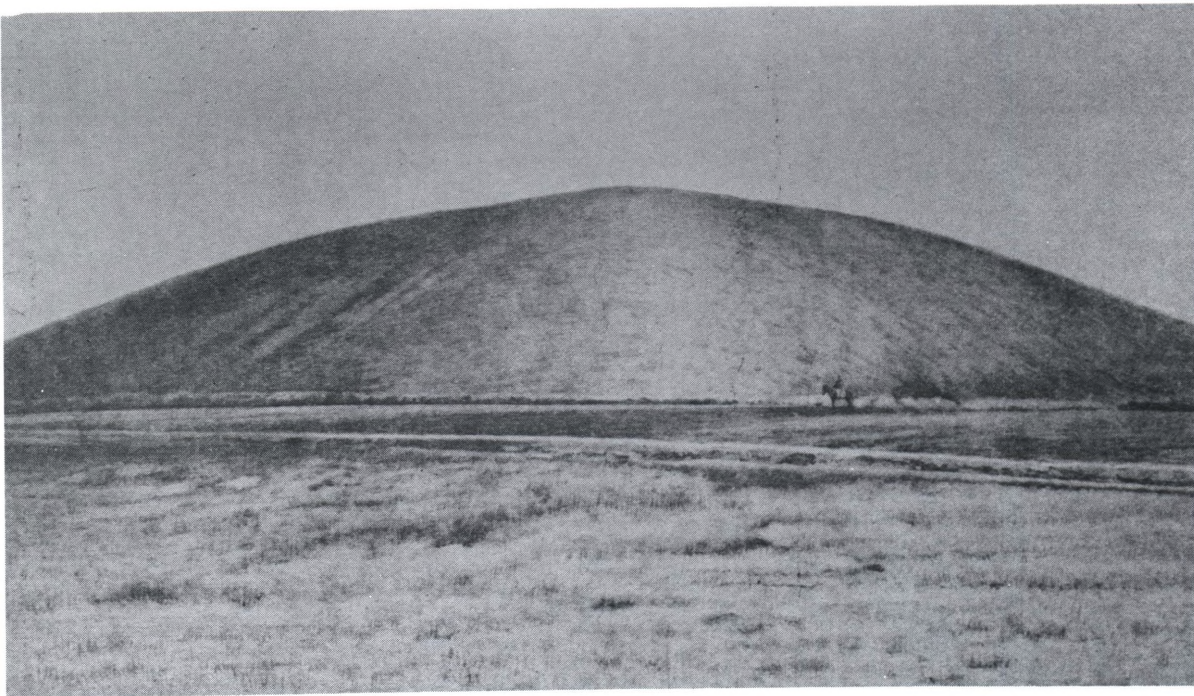

Shensi Pyramid. Its age and purpose are unknown, shafts dug into it at various times revealing no burials, or in fact chambers of any kind.

Enquiries sent to the Chinese on a number of

subjects have so far gone unanswered, but we shall try again to see whether they have changed their minds about the existence of these pyramids and whether anything at all has been done about them.

ADMINISTRATIVE AFFAIRS

We are sorry to report that Mark Hall has had to return to his home for personal reasons. As we have noted before, he has been of exceptional help to the Society during a most difficult period, and it had been hoped that he could remain on the Board of Trustees after his return home. However, circumstances have made this unfeasible.

With Mr. Hall's departure, Robert C. Warth takes over as Acting Director though he is not resident here. Our Treasurer, Allen Noe, who lives nearby and is now on forced early retirement, has pitched in to help with the work at our headquarters, and is here nearly every day.

Please, once again, let us know of any change of address as far in advance as you can. Third class mail is not forwardable unless you make a special request of the post office. If it is returned to us, the local post office sometimes indicates your new address, but not always—in which case it becomes impossible to get Pursuit to you until you get around to giving us your new address. And always include your zip code; Pursuit does not go through without it. We have a zip code directory, but it does not give a complete breakdown of codes within major cities. Thank you.

MEMBERS' FORUM

Member #1471 is interested in reports of large snakes (really oversized ones) in the United States in the 1950s. Anyone having such reports, or references to such, is asked to get in touch with us. He is also interested in reports of UFOs between 1942 and 1946.

Survival Kits: Since many of our members have at least expressed an interest in visiting rather out-of-the-way areas for one reason or another, it may be appropriate to list here some basic items which should be carried at all times. "Survival kits" are usually available at sporting goods stores and generally are small enough to fit in a shirt pocket. However, they can be assembled quite easily. The container can be made from a small metal box which should be taped shut so that it is waterproof. Mrs. Joyce MacDuffie, an expert on wilderness survival, suggests the following contents: kitchen matches dipped in paraffin, string dipped in paraffin, a wad of very fine steel wool ("it burns even when wet"), some picture-hanging wire (for snares), tape, safety pins, leader for a fishing line, chlorine tablets, fish hooks, aluminum foil, finishing nails, vitamin pills, salt, antibiotic ointment (check with your pharmacist if you have any allergies to any antibiotics!), adhesive bandages, a whistle, and a piece of mirror glued to the inside of the box cover. We would add a compass, razor blades, tropical chocolate bars if you can get them, salt and dextrose tablets, and a snakebite kit (check for the most recent types—methods change periodically) if there are any poisonous snakes in your area. Needless to say, you really should not go

into any wilderness area without at least a general map of that area and, if it is really a wilderness area, you should 'register' with the local police, telling them where you plan to go and approximately how long you intend to be there.

Member #1436 is investigating a particular "spook light" and would like to hear from other members who have experience in this field. Specifically, he would like to know of any patterns that have turned up: seasonal, associated with phases of the moon, time of day or night, and the like; and will also be grateful for suggestions concerning equipment that might be useful in studying this phenomenon.

THINGS TO COME

Work done by Marjorie Fish on a three-dimensional star map which goes far toward confirming the star chart drawn by Betty Hill while under hypnosis, will be reported on at length in a future issue or issues of Pursuit. The article which appeared in Saga Magazine was inadequate in a number of ways, and Ms. Fish will be given all the space she needs in Pursuit to present a full and accurate account.

BACK ISSUES OF PURSUIT

Our supply of some back issues of Pursuit is dwindling rapidly and when these are gone, these issues will not be available even as Xerox copies. Anyone wishing copies of these issues should order

promptly. Those in short supply are as follows:

- Vol. 2, No. 1, a fair supply
- Vol. 2, No. 2, few
- Vol. 2, No. 3, very few
- Vol. 2, No. 4, very few Xerox copies left (\$2.00 each)
- Vol. 3, No. 1, few
- Vol. 3, No. 3, fair supply
- Vol. 3, No. 4, few

We have available the following papers (Xerox copies); the price includes first class postage (for the U.S., Canada and Mexico).

"The Two Gravitational Fields and Gravitational Waves Propagation" by John Carstou, \$1.75

"Gravitation and Electromagnetism—Tentative Synthesis and Applications" by John Carstou, \$1.75

"An Experiment in Dowsing" by Ivan T. Sanderson, \$1.75

"The Fitzgerald Report" by Robert J. Durant, \$2.50
 "Journal of the Interplanetary Exploration Society",

Vol. 1, No. 3, (December 1961). Contains articles on ancient space travel, plus Ivan T. Sanderson's "Non-Cuverian Cataclysms". \$3.50.

We also have a very limited number of "tear sheets" of some of Ivan T. Sanderson's articles from Argosy. These include "This 'Airplane' Is More Than 1,000 Years Old!" (November 1969); "The Five Weirdest Wonders of the World" (a title not to be taken too seriously) (November 1968); "Visitors from Outer Space..." (February 1969); "The Spreading Mystery of the Bermuda Triangle" (August 1968); and "Wisconsin's 'Abominable Snowman'" (April 1969). These are available on a first-come, first-served basis for \$1.50 each including first-class postage.

For those who lacked the money to buy the hard-cover edition of Ivan T. Sanderson's book Invisible Residents, this is now available in paperback as an Avon Book, 95¢. So far as we know, the paperback rights to Investigating the Unexplained are still hanging fire.

THE IVAN T. SANDERSON MEMORIAL FUND

Members are reminded once again that contributions to the Society are deductible for income tax purposes and that they will help us to serve you better. Our immediate need is a good copier; we are now dependent on outside copying services, and these are more expensive — for you as well as for us — and also a nuisance. Your contributions to the Ivan T. Sanderson Memorial Fund will help us to grow and make SITU a living memorial to Ivan and the work he began. We may never finish it, but we would like to try.

DEPARTMENT OF LOOSE ENDS

Just in case there is any question about it, the Banana River, mentioned in Ivan T. Sanderson's article on luminous men (July 1973), is in Florida.

Member #1176, discussing the prediction of 'geons' by Prof. Wheeler ("Worm-Holes" in Space", July 1973, p. 64), notes that "Jules Verne 'predicted' the submarine with such clarity and accuracy that when it was finally produced by man it was unable to be patented."

Those who might like to experiment with building "Pharaoh's Pump" will want to get copies of Edward J. Kunkel's patent from the Patent Office: they should ask for "Hydraulic Ram Pump", Patent No. 2,887,956.

As yet we have no further information on the Caspar, Wyoming, mummy, but still want very much to track this down. And we cannot resist quoting Paul Willis of INFO who notes, "I doubt that the thing is very modern though —obviously if the little guy was anencephalic and had been alive in modern times, he'd have run for Congress".

Further references to the Great Wall of Peru are: Flights into Yesterday by Leo Deuel, St. Martin's Press (New York), 1969; and The Geographical Review, January 1932.

A CORRECTION

Nils O. Jacobson of Sweden, author of the book entitled Life After Death, did not himself conduct any experiments on "weighing the soul" by placing terminally ill patients on scales and noting any weight loss at the moment of death. In fact, he simply reported the earlier experiments by Duncan MacDougall. The allegation that he did so apparently originated with an inattentive reporter at a press conference in Dusseldorf, Germany. Dr. Jacobson's book will be published in the U.S.A. late this year by Seymour Lawrence Inc. of Boston, Mass. No publication date or price are known to us.

We apologize to the Saturday Evening Post for having labelled it extinct. It did indeed 'fold' several years ago, but has been resurrected though not, apparently, on a weekly basis.

Members are reminded that dues —still \$10 per annum— are payable before the end of this year. May we also suggest that membership in SITU will make an excellent Christmas gift for that special person on your list. We would advise that you renew your own membership and send in new ones before the 1st January since skyrocketing costs may require us to raise our rates next year. If you wish to renew for more than one year, you will not then be affected by any increase in dues.

Members are urged to find us new members. We will be happy to supply copies of our "brochure" to anyone requesting them.

SLANDER AGAINST IVAN T. SANDERSON

We are informed that a Mr. Bob Parsons has been exhibiting a "specimen frozen in ice" —in fact an obvious fake— labelled a "Missing Link" and alleged to be that reported in Argosy Magazine in 1969. This is said to have been exhibited in Massachusetts this past summer, and Mr. Parsons is reported to have claimed that he "rented the Missing Link from Ivan T. Sanderson last spring". We are making further inquiries about this and will appreciate any help that our members can give us. Should the facts prove to be as stated, suit will be brought against Mr. Parsons, asking damages for slander.

BOOK REVIEWS

by Sabina W. Sanderson

Elaine Morgan. The Descent of Woman. New York: Stein & Day. 1972. (Price unknown) New York: Bantam Books. 1973. \$1.75. London: Souvenir Press. ?1972. £2.50.

This book has caused and will undoubtedly continue to cause considerable controversy, much of it —in my opinion— for all the wrong reasons. Even the reviewer in the New Scientist, a woman at that, devoted 4" to the first ten chapters and 8½" to the last two which deal in cursory fashion with what is usually called "Women's Lib".

As Mrs. Morgan points out:

"She was there all along, contributing half the genes to each succeeding generation. Most of the books forget about her for most of the time. They drag her onstage rather suddenly for the obligatory chapter on Sex and Reproduction, and then say: 'All right, love, you can go now,' while they get on with the real meaty stuff about the Mighty Hunter..."

The basic thesis of Mrs. Morgan's book is that human evolution was influenced far more by the female of the species than the male. Obviously this will not and does not please many men, though it has always been my observation that men who are certain of their masculinity do not worry about "competition" from women.

The suggestion that truly human as opposed to general primate evolution actually took place in an aquatic environment was first made by A. C. Hardy back about 1960, but it did not seem to catch on much, and Prof. Hardy has not, to my knowledge, presented a really detailed picture of what may have happened. Mrs. Morgan does, and it makes sense —much more sense than many if not most of the others that have been published. She has used the examples of current primitive peoples' behavior as her model for the behaviour of 'prehistoric' man, thus avoiding some of the absurdities that crop up in other books; and when she does 'invent' incidents to suggest a possible, or even probable, origin of some facet of human behaviour (in its widest sense), she keeps it within the bounds of common sense —an all too rare commodity in any case.

According to Mrs. Morgan's outline of Man's evolution, there never was a truly aquatic period but rather an amphibian one: and the reasons given for this shift to a semi-aquatic existence are very plausible, as are those for our return to terra firma. The gross differences between Man and Apes are due, however, to this probably lengthy sojourn at the seaside, which resulted in our having in some ways more in common with dolphins than apes.

For heaven's sake, buy this book and read it thoroughly. Apart from stretching the mind, it is great fun and unqualifiedly worth reading.

Lyall Watson. Supernature. Garden City, N. Y.: Anchor Press/Doubleday. 1973. \$7.95

This is an excellent book for confirmed sceptics and non-forteans; it will, most of it, make rather dull reading for those already familiar with the borderlands of science. The author notes that

"All the best science has soft edges, limits that are still obscure and extend without interruption into areas that are wholly inexplicable.. On the fringe, between those things that we understand as normal occurrences and those that are completely paranormal and defy explanation, are a cluster of semi-normal phenomena....that I choose to describe as Supernature."

This book is divided into four parts: Cosmos, Matter, Mind, and Time. The last two are more interesting than those on Cosmos and Matter, which deal primarily with phenomena that are respectable enough to earn government grants for their investigators and thus put them outside the field of true forteana. However, they are just the kind of thing needed to upset the aggressively orthodox —for whom the book is probably intended in any case. Also for their benefit, there are more than adequate references (called a bibliography) and a good index.

Lyall Watson does cover "Supernature" pretty thoroughly though he does not devote a great deal of space to any one thing. In some cases he gets a bit carried away, e.g. astrology, on which he waxes quite eloquent, only to admit finally that "astrology is particularly weak and open to criticism in the field of prediction". Inasmuch as this is the astrologers' basic claim, this weakens his argument rather seriously. He displays a similar naivete elsewhere, but these lapses are not frequent enough to do any real damage.

Forteans will want to skim through this book for items and ideas that are new to them, but are advised that it will make an excellent Christmas present for a stuffed shirt.

James B. Sweeney. A Pictorial History of Sea Monsters and Other Dangerous Marine Life. New York: Crown Publishers. 1972. \$9.95

This is a "coffee-table book", i.e. oversize, with lots of illustrations (372 in fact), but with more text than is found in many books of this genre. Unfortunately, the text leaves much to be desired. It will set the informed reader's teeth on edge and will mislead the uninformed. In addition it suffers from rather blatant 'padding'; in a number of cases the author has been reduced to saying that an animal is "totally inoffensive" (the Basking Shark) but awfully big, or likely to retaliate if attacked (who wouldn't?), etc., and therefore is "dangerous".

The book is divided into two parts, Part One on "Sea Monsters" and Part Two on "Other Dangerous Marine Life". Part Two is divided into four sections— "Killers and Their Close Relatives", "Dangerous Through Size", "Stingers and Shockers of the Sea", and "Poisonous to Eat". There seems to be no particular scheme for the placement of illustrations in Part One —they are simply dumped in— though those in Part Two generally accompany the text references (except for the Giant Squid trapped in Trinity Bay, Newfoundland, which is discussed on page 201; the illustration faces page 87). One also suspects that the author ran out of captions for the illustrations; some of these are a bit bewildering, to say the least. On page 120, an enormous 'fish' with very large fangs is attacking a boat (with two masts, yet), and the caption reads "Some who have seen the Loch Ness monster have said that it resembles this sixteenth-century sea monster, depicted by Olaus Magnus in 1555". Aside from the fact that this is a sixteenth-century drawing of a sea monster, I cannot recall a single description of a Loch Ness monster that even remotely resembles this. Again, on page 27: "The terms sea monster and sea serpent became interchangeable. When erect, the creature is often called a sea monster; but when swimming, it becomes a sea serpent."

To be blunt, I fear the author does not write very well. In some cases he is guilty simply of vast oversimplification, as when he states "...the elephantlike giants called mammoths, split into factions, some preferring the sea. We now know them as the familiar manatee, or sea cow" (!); but in others he has either forgotten how to write English or has been wretchedly edited. For example: "An inventory of shark attacks reveals that the worst violators, in order of frequency, are: first, mackerel shark; second, requiem shark; third, sand shark; fourth, hammerhead shark; and fifth, many sharks of unknown species." Another beauty appears on p. 28: "Germany's Lorelei has long been an inspiration as a tourist attraction that is still pointed out to foreign visitors. This particular siren is said to sit on a cliff..." So far as I know, it is the cliff, not the siren, that is the tourist attraction.

There are a fair number of outright mistakes sprinkled through the text (and the captions for illustrations), and several misspellings which cannot be attributed to simple typographical errors, e.g. Loch Morar is invariably spelt 'Morer'. And this apart from the fact that neither Loch Ness nor Loch Morar has any place in a book on sea monsters. Some of the infelicities are most probably the work of an 'editor' (whoever it is, he or she apparently loathes hyphens, thus producing such monstrosities as 'eellike' and 'sentinellike').

Despite the fact that the author is pro sea monsters, we cannot recommend this book.

R. L. Dione. God Drives a Flying Saucer. New York: Bantam Books. 1973. \$1.25.

Don't bother with this. It's largely drivel.

John Philip Cohane. The Key. New York: Crown Publishing Company. 1969. \$7.50.

There was a man who was struck by the similarity in Waikiki and Wichita. So he said (p. 180) "The only logical explanation I can think of is that the same names were taken in prehistoric times from one common source, and then, through lack of communication, and with people remembering less from generation to generation, they took on a wide assortment of local meanings that had nothing to do with the original ones. Being ancient, however, they were regarded with reverence and tampered with as little as possible." And he made it his life work to demonstrate, by means of the world-wide distribution of each of six key "names", that mankind in the person of far-ranging, Mediterranean-based Semites fanned out across the face of the earth from one common origin point.

Concerning the efforts of dedicated Atlantists to prove by random linguistic similarities the existence of Atlantis, L. Sprague de Camp (in Lost Continents, p. 101) snorted, "Such considerations [phonology, inflection, syntax] never bother the Atlantists, however, who seize upon any chance resemblance of names or other words to prove their case. By their methods I could, for instance, 'prove' that the Amerinds are the descendants of colonies from ancient Greece: I could derive the Croatan Indians from Crotona in Italy, the Cherokees from Kerkyra, the Chilkats from Chalkis, the Mandans from Mantinea, and the Aleuts from Eleusia. Why not?" The scorned derivations of the Atlantists involved whole words. Imagine how vastly the comparative process can be expanded, what unlikely relationships can be expounded, if instead of randomly similar words the exponent seizes upon randomly similar combinations of two or three letters—in English, regardless of the language source—comprising a portion of a name of anything. The proof? Built of moonbeams, bottomed on quicksand.

Suppose—just suppose, mind you—that before there was a language identifiable as English, there were two gods, or heroes, or whatever, whose names would be rendered in English as Haue and Oc. And suppose that the victors of a particularly bloody fracas triumphantly saluted Haue! Oc! Havoc!

This author's search for linguistic evidence of mankind's common source is havoc indeed. A process of indiscriminate removal, insertion, and change of vowels and consonants which the author unblushingly asserts are "equivalent" proves that Avebury (Hauebury) in England and the Incan Empire (Anahuac) share a common source. OCs, OGs, OCHs, HAWWAHs, ALAs, and AVAs are scattered through this book with never a reminder that in most instances these name-fragments represent some Englishman's effort to make familiar, if not intelligible, the gabble of a benighted heathen. [Just to indicate how helpful 'English' spellings can be, a pamphlet published in Boston in 1836 with a Seneca Amerind text is entitled "Diuhsawahgwah Gayádosháh. Gówahás Goyádoh. Sgáóyadhí dówánandenyó". Ed.]

So we are conducted from China's Yalu to Florida's Yellow to Mexico's Yalalag to Turkey's Yalak to Australia's Yallock. Do they really prove worldwide distribution of the ancient Aya-Ala/Ala-Ala/Ala-Og-OC? We are reminded of William S. Baring-Gould's jocular proof that Nero Wolfe was sired by Sherlock Holmes: "...and surely it is no coincidence that his Christian name contains the er-o of Sherlock, and his surname the ol-e of Holmes."

We are not convinced that the worldwide distribution of OG, Hawwah, Ala, Mana, Tema, and Ash or sounds more or less like them prove the author's thesis, but we must admit that new worlds of speculation are opened by The Key.

J. Warner Mills III

INDEX — VOLUME 6

ONTOLOGY

'Worm-Holes' in Space, 64

PHYSICS

Coanda Effect, The, 32

CHEMISTRY

Alleged Fallout-Free Water, 10, 47

ASTRONOMY

Life on the Moon?, 13, 47

Mariner 7, 47

Moons of Mars, The, by Robert J. Durant,

11

Planet X, 66

Saturn's Rings, 32

Tunguska "Meteorite", The, 82

GEOLOGY

Erupting Rocks, 33

Has the Earth Shifted?, 33

Lightning Again, 82

Mediterranean, The, 13

On the Subject of "Cold", 13

Pre-Earthquake Phenomena, 83

BIOLOGY

ABSMal Affairs in Pennsylvania and Elsewhere,
by Allen V. Noe, 84

- Ancient Seeds, 16
 Beware an Alleged 'Bigfoot' Skeleton, 37
 "Blob, The", 67
 Botanical Puzzle, A (Bamboo), 68
 Current Search and Research of ABSMs, 36
 Florida's Wild Wildlife, 37
 Giant Herbs, 15
 Giant Skeletons, 69
 "Horrors" from the Mesozoic, by Mark A. Hall, 40
 Luminous People and Others, by Ivan T. Sanderson, 66
 More New Cats?, by Ivan T. Sanderson, 35
 Nomeus—A Fish That Disappears, by Craig Phillips, 38
 Paraguayan "Barking Snake", The, 14
 Pearls in Hens' Eggs, 15
 Scaly Beast, A, 17
 Second Lobster Mystery, A, 16
 That New Very Human-looking Skull, 14
 Tropical Fish in Siberia, 16
- ANTHROPOLOGY**
 Chinese Pyramid, The, 93
 Julsrud Ceramic Collection in Acambaro, Mexico, The, 41
 Kirkbride's Wall and the Great Wall of Peru, 43
 Leys—Ancient British Power Network, by Janet Bord, 70
 Linguistic Surprise, A, 19
 Metallic Balls from Here!, 19
 More on Mercury Engines, 20
 Not the Salzburg Steel Cube, but an Iron Object from Wolfsegg, by Hubert Malthaner, 90
 Pharaoh's Pump, by Adolph L. Heuer, Jr., 71, 96
 "Yesu" of the Druids, 18
- UFOLOGY**
 Can We Tick Off Another One?, 4
 Mystery Airship, The, 55
 Possible Alien Space Probe, A, 28
- CHAOS AND CONFUSION**
 Avenger Flight; and Others, The, 79
 Bermuda Triangle, Again, The, by Robert J. Durant, 55
 Cat Conclave, A, 6
 Chipmunks and ITF, by Sabina W. Sanderson, 59
 "Chopped-off" Corn, 59
 Eagle Requiem, by Stanley W. Tyler, 29
 Entombed Toads, by Sabina W. Sanderson, 60
 He Talked with the Seagulls, 81
 Light "Wheels" Under the Sea, 7
 Mary Celeste, The, 5
 Mermaids, 80
 One of the PKs to the Fore, 5
 Spook Lights, 31
 Stone, England, Mystery Bell, The 20
 That Disappearing Eskimo 'Village', 38
 Unnatural Darkness, 29, 82
 Weighing the Soul, 30, 97
 Who's Down There?, 30
- Whose Point of View?, 78
 Why Did the Foxes Sing?, by John Stuart Martin, 57
- MISCELLANEOUS**
 Books in Paperback, 48
 Department of Loose Ends, 20, 47, 96
 Editorials: by Hans Stefan Santesson, 78
 Great Semantic Mess, The, by Ivan T. Sanderson, 3
 Our Greatest Crisis?, by Sabina W. Sanderson, 54
 Sensible Breakthrough at Last, The, by Ivan T. Sanderson, 27
 In Memoriam—Ivan T. Sanderson, by Sabina W. Sanderson, 26
 Members' Forum, 21, 73, 95
 Papers Available in Xerox Form from SITU, 21, 97
 Translating Charles Fort's Notes, by Carl J. Pabst, 46
- BOOK REVIEWS**
 (By Sabina W. Sanderson—nom-de-guerre Marion L. Fawcett— unless otherwise noted)
Before Columbus: Links Between the Old World and Ancient America, by Cyrus H. Gordon, 48
Beyond Stonehenge, by Gerald S. Hawkins, 74
Biological Rhythms in Human and Animal Physiology, by Gay Gaer Luce, 51
Body Time, by Gay Gaer Luce, 51
Children of the Sun, The: A Study in the Early History of Civilization, by W. J. Perry, 48
Crash Go the Chariots: An Alternative to Chariots of the Gods?, by Clifford Wilson, 52
Descent of Woman, The, by Elaine Morgan, 97
Emergence of Man, The, by Time-Life Books, 51
God Drives a Flying Saucer, by R. L. Dione, 99
Great World Mysteries, by Eric Frank Russell, 23
Key, The, by John Philip Cohane, rev. by J. Warner Mills III, 99
Limbo of the Lost, by John Wallace Spencer, 23
Pattern of the Past, The, by Guy Underwood, 75
Phantoms of the Sea, by Raymond Lamont Brown, 74
Pharaoh's Pump, by Edward J. Kunkel, 51
Pictorial History of Sea Monsters and Other Dangerous Marine Life, A, by James B. Sweeney, 98
Record, The, 23
Sasquatch File, The, by John Green, rev. by Mark A. Hall, 76
Search for Morag, The, by Elizabeth Montgomery Campbell and David Solomon, 74
Self-Publishing Writer, The, 23
Supernature, by Lyall Watson, 98
UFO's—A Scientific Debate, by Carl Sagan and Thornton Page, Eds., 24
Vertex, The Magazine of Science Fiction, 74
Viking America: The Norse Crossings and Their Legacy, by James Robert Enterline, rev. by Ivan T. Sanderson, 22
We Are Not the First, by Andrew Tomas, 73

THE SOCIETY FOR THE INVESTIGATION OF THE UNEXPLAINED

GOVERNING BOARD

Trustee (and President)	Hans Stefan Santesson
Trustee (and Vice-President)	Robert C. Warth
Trustee (and Secretary)	Sabina W. Sanderson
Trustee (and Treasurer)	Allen V. Noe
Trustee	R. Martin Wolf
Trustee	Robert J. Durant
Trustee	Dante A. Costa
Trustee	Stanley W. Tyler

EXECUTIVE BOARD

Director (Acting)	Robert C. Warth
Executive Secretary	Marion L. Fawcett
Technical Consultant	Robert J. Durant
Research Consultant	Carl J. Pabst
Mass Media	Walter J. McGraw
Public Relations	Dante A. (Don) Costa

EDITORIAL BOARD

Editor and Publisher	Hans Stefan Santesson
Executive Editor	Marion L. Fawcett
Consulting Editor	Walter J. McGraw
Assistant Editor	Robert J. Durant

SCIENTIFIC ADVISORY BOARD

- Dr. George A. Agogino – Chairman, Department of Anthropology, and Director, Paleo-Indian Institute, Eastern New Mexico University. (Archaeology)
- Dr. N. Burtshak-Abramovitch – Academician, Georgian Academy of Science, Palaeobiological Institute; University of Tblisi. (Palaeontology)
- Dr. Carl H. Delacato – Associate Director, Institutes for the Achievement of Human Potential, Philadelphia. (Mentology)
- Dr. W. C. Osman Hill – Dublin and London (Comparative Anatomy)
- Dr. J. Allen Hynek – Director, Lindheimer Astronomical Research Center, Northwestern University. (Astronomy)
- Dr. George C. Kennedy – Professor of Geology, Institute of Geophysics, U.C.L.A. (Geomorphology and Geophysics)
- Dr. Martin Kruskal – Program in Applied Mathematics, Princeton University. (Mathematics)
- Dr. Samuel B. McDowell – Professor of Biology, Rutgers University, Newark, N. J. (General Biology)
- Dr. Vladimir Markotic – Professor of Anthropology, Department of Archaeology, University of Alberta, Canada (Ethnosociology and Ethnology)
- Dr. Kirtley F. Mather – Professor of Geology, Emeritus, Harvard University. (Geology)
- Dr. John R. Napier – Unit of Primate Biology, Queen Elizabeth College, University of London. (Physical Anthropology)
- Dr. W. Ted Roth – Assistant Director, Baltimore Zoo, Baltimore, Maryland. (Ecologist & Zoogeographer)
- Dr. Frank B. Salisbury – Head, Plant Science Department, College of Agriculture, Utah State University. (Phytochemistry)
- Dr. Berthold Eric Schwarz – Consultant (Brain-Wave Laboratory), Essex County Medical Center, Cedar Grove, New Jersey. (Mental Sciences)
- Dr. Roger W. Wescott – Professor and Chairman, Department of Anthropology, Drew University, Madison, New Jersey. (Cultural Anthropology and Linguistics)
- Dr. A. Joseph Wraight – Chief Geographer, U. S. Coast & Geodetic Survey. (Geography and Oceanography)
- Dr. Robert K. Zuck – Professor and Chairman, Department of Botany, Drew University, Madison, New Jersey. (Botany)

