

# BORDERLANDS

*THE CROSSROADS OF SCIENCE & SPIRIT*

Volume XLIX, Number 3, Third Quarter 1993

*Fourth Dimension* ..... 1

*Mystery Hill*..... 22

*Tremendous Power!*.... 28

*Ancient Engineers*.... 31

*News & Views* ..... 40



# Puzzling Evidence

# **BORDERLANDS**

## *THE CROSSROADS OF SCIENCE & SPIRIT*

**Borderlands** is a quarterly publication of Borderland Sciences Research Foundation, P.O. Box 429, Garberville, California, U.S.A. Phone 707-986-7211, Fax 707-986-7272. Contents © 1993 by BSRF.

*Editor-in-Chief*  
Thomas Joseph Brown

*Associate Editor & Production Assistant*  
Alison Davidson

*Associate Editors*  
Peter Lindemann & Michael Theroux

**Borderland Sciences Research Foundation** was founded by Meade Layne in 1945 for the purpose of investigating into realms normally beyond the range of basic human perception and physical measurement. B.S.R.F. is a non-profit scientific and educational foundation directed by Thomas J. Brown. Meade Layne directed from 1945 to 1959. Riley Hansard Crabb, from 1959 to 1985.

**Borderlands** originated as Meade Layne's **Round Robin** in 1945 and was changed to **The Journal of Borderland Research** in 1959. It was changed to **Borderlands** in 1992. **Borderlands** is an information nexus for thinkers and doers on the frontiers of science and awareness.

**Borderlands** is available to members of Borderland Sciences Research Foundation. BSRF Membership fees are:  
\$25/year, worldwide, Regular Membership  
\$15/year, Senior Citizen Membership  
\$50/year, Supporting Membership  
\$100/year, Sustaining Membership  
\$1000, Lifetime Membership  
Membership entitles you to **Borderlands** for the duration of your membership term. **Borderlands** is sent bulk mail in the U.S. and ISAL overseas. Single issue \$6.95

**The main fund-raising activity of BSRF** is to act as an educational clearing-house for information, and to actively seek donations to fund our activities.

**All published materials** are presented for Informational and Research purposes only. Authors are solely responsible for the information and opinions they present. This material is not to be construed as expert opinion or medical advice, it is research into the **Borderlands**...

## **FORWARD MOTION ...**

**W**E live in an age where vast amounts of information traverse our planet. The mainstream of information leads the way, clogging the channels with the lowest common denominator. There is also a lot of activity in spreading alternative information: political, scientific, medical, etc. There seems to be a basic law of alternative information — the goofier it is, the more readily people will believe it, and defend it against the obvious; the more real and verifiable, the less it is accepted. Facts are meaningless when people's minds are made up. Just because something is claimed to be "alternative" folks will line up to mindlessly to parade its cause. From dubious "survivors" of unverifiable government black projects, on to "free energy secrets" that confuse and lead nowhere, the cause of misleading information is going strong. But in these pages we work towards the Truth, always ready to correct any errors of fact. Sure we speculate, that's part of what it's all about. But we work hard not to be fooled. We hope you do the same...  
Tom Brown, Editor-in-Chief

# **BORDERLANDS**

**Volume XLIX, Number 3, Third Quarter 1993**

## *TABLE OF CONTENTS ...*

### **PUZZLING EVIDENCE**

Tom Brown ... 1 - 6

### **LEAD, SATURN & SATURNISM**

Nick Kollerstrom ... 7 - 11

### **THE PUNDIT CURMUDGEON: *Defining Perpetual Motion***

Ed O'Brian ... 12 - 14

### **THE RESONANT VORTEX**

R. Louis Richards ... 15 - 19

### **LEVITATION QIGONG & CHINESE LIQUID GOLD**

Dr. G.K. Knowlton ... 20 - 21

### **FLIX KURNER: *Unmasking the Invisible***

Peter A. Lindemann ... 22 - 23

### **HARMFUL EARTH RADIATION ... 23**

### **STRANGE PHENOMENA AT URITORCO HILL**

Jorge Resines ... 24 - 25

### **THE CLASSICAL ETHER-CONCEPT AS A POTENTIAL MODERN THEORETIC UNIFYING PRINCIPLE**

by Michael Baran ... 26 - 27

### **TREMENDOUS NEW POWER ... 28 - 30**

### **SCHAUBERGER VS. ARCHIMEDES *Conclusion***

Albert Zock... 31-39

### **MEDICAL HYDROLOGY IN AYURVEDA**

Dr. E.A.V. Prasad ... 48

### **THE B.S.R.F. BULLETIN BOARD ... 40 - 49**

PUZZLING EVIDENCE:

CITY  
OF  
THE  
DEAD



# THE 4TH DIMENSION

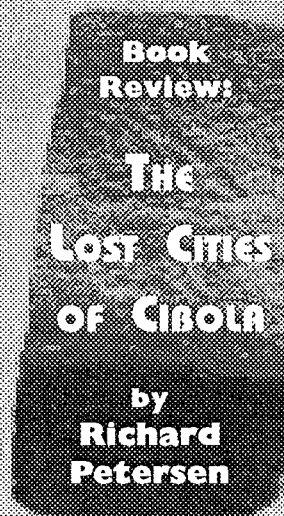

*Curious is the legend of the fabled Lost Cities of Cibola ... a legend rooted in the vast southwestern desert of Arizona, that has risen from time to time to stir the imagination, only to sink back into the obscurity of dark and dusty bookshelves. But this legend refuses to die and with such persistence its origin deserves a closer scrutiny.*

The first reference we have to the lost cities comes from Nuno de Guzman, President of the first Audiencia in New Spain (Mexico), who was told by an Indian servant that "as a boy he had gone with his father to large cities in the north which compared in size to Mexico City itself". The cities were said to be about 40 days travel north of Mexico City. Excited by the lure of conquest de Guzman set out with an army in 1530, but he was ill-equipped for the mountainous terrain and called the expedition off, content to carve out a province he named New Galicia — and to make himself the first governor.

Six  
years  
later

BY TOM BROWN  
& ALISON DAVIDSON

WITH SPECIAL THANKS TO  
RICHARD HORTON



four survivors of the ill-fated Narvaez expedition to conquer Florida stumbled gaunt and hungry into de Guzman's province. During their journey of escape to the west they too had heard Indians speak repeatedly of wonderful cities further to the north, apparently in Arizona, and were even shown items said to come from there. A heroes' welcome awaited the four men in

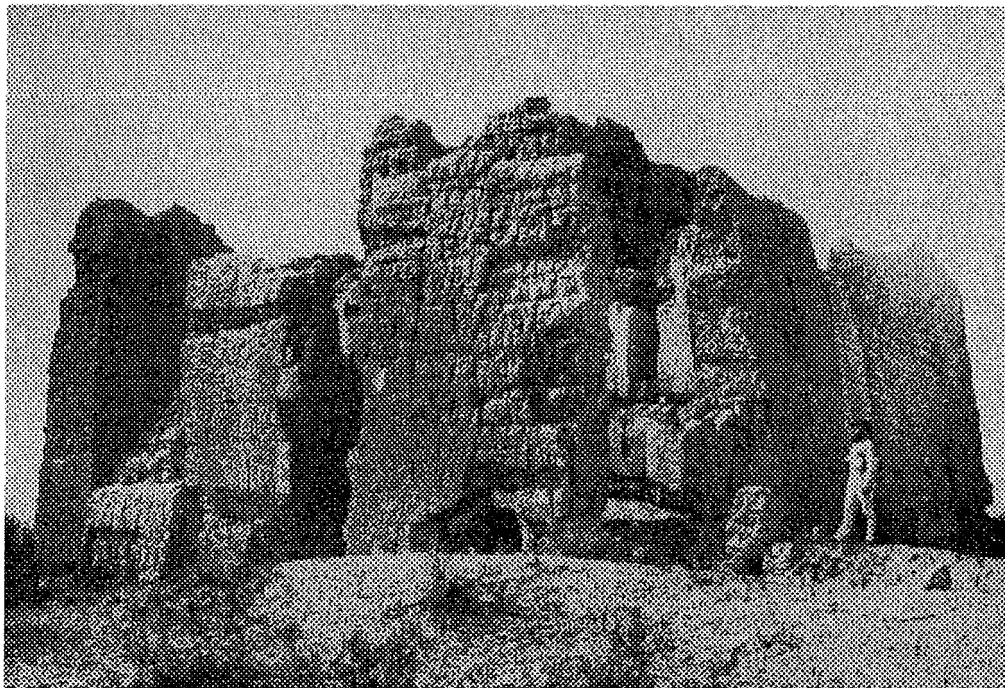

Casa Grande, (Totontec?) circa 1880s, photo by Henry Buehman

Mexico City. The Viceroy of New Spain, Don Antonio de Mendoza was greatly interested in their reports and anxious to determine their truth, so in 1539 a Franciscan monk, Marcos de Niza, was chosen to lead the official expedition and accompanying him was an Arab slave, one of the four survivors, named Estaban.

It was the lengthy report of Fray Marcos on his return from this long and perilous journey into uncharted territory that gave flesh to the legend of the Cities of Cibola — and later, great controversy and personal tragedy.

They set off on a path up the west coast of Mexico, through the harsh Sonoran Desert and on towards the area in Arizona where modern-day Phoenix now lies. Fray Marcos ordered Esteban on ahead with instructions to send back messages along the way. Before long a message arrived urging Fray Marcos to come immediately. It was conveyed by an Indian Estaban had met, someone who had been to the cities himself: seven of them, he said, and all under the rule of one great lord.

As Fray Marcos continued north he gathered information from Indians who lived in territories bordering the cities which confirmed and elaborated on his initial reports. The Indians traded their labor in the cities for expertly tanned cowhides, turquoises and other precious items and they described a large and highly sophisticated population, wearing beautiful jewelry and clothed in fine cotton and woolen clothing.

He repeatedly heard detailed descriptions of the houses, the streets and squares, how the houses were constructed of stone and lime, the smallest of one story with a terrace above, the largest of several stories accessed by ladders, and the doorways of the principal houses were greatly ornamented with turquoise. Cibola was the first of the seven cities and the ruling lord lived in Ahacus, the largest and most important of the seven. But there were other kingdoms beyond "each of which was much bigger than that of

these seven cities" named Marata, Acus and Totontec.

Marata lay to the southeast (where the great ruin of Snake town now lies) and its houses were also built of stone and many stories high, but it had been considerably reduced by a continuing war with the lord of the seven cities. Totontec was said to be the most populous and the richest

kingdom and lay to the southeast, in the region of Casa Grande. Acus probably referred to the Verde Valley, including the ruin now known as Montezuma's Castle.

But so close to their goal and only days away from Cibola, tragedy struck the expedition. Two of the Indians who were accompanying Estaban returned to Fray Marcos bloody and wounded. From them he learned that Esteban had reached the great city, but was rebuffed and eventually slain along with most of the 300 Indians with him.

Now the monk feared for his own life but was determined to see the cities — he was, after all, a reliable agent on a highly important mission. His personal narrative reports that Cibola, which he viewed while hidden in nearby mountains "appears to be a beautiful city" ... "bigger than Mexico City" with houses just as the Indians had described. The Indian chiefs who unwillingly accompanied him said that "it was the least of the seven cities and that Totontec is much bigger and better than all seven, and that it has so many horses and people that there is no end to it."

Hidden in the mountains he piled up a heap of stones, placed a small cross on top and claimed possession of the country he feared to approach in the name of Mendoza and the Emperor of Spain, then sadly, and afraid for his life, he hastily retraced his path to Mexico.

Upon his return and fired by his account of the wonderful cities, a new expedition was immediately organized with Francisco Vazquez de Coronado appointed Captain General. Fray Marcos went along to point the way, but somehow, for some reason we may never fully know, Coronado and his army never arrived at their destination. They never reached the great cities of stone and found only what they considered rude villages inhabited by people who called themselves Zuni. Fray Marcos was branded as a liar and his meticulous earlier report was judged to be a fabrication. It was a very curious situation.

## THE LYING MONK?

Richard Petersen, author of *The Lost Cities of Cibola*<sup>1</sup> — from which this narrative derives — suggests in his book that Fray Marcos de Niza took the fall as an honorable man; that he played the role of liar so the army would not have to attack Cibola, an apparently much stronger foe than Coronado's force could handle. Petersen suggests that when Fray Marcos appraised the situation and had the chance to warn Coronado of the overwhelming odds, the expedition took a different direction (as it seems, from Coronado's own report). Fray Marcos took the fall to 'save the face' of the Captain General and the lives of 1300 men.

It is easier to believe that conclusion, because it upholds Fray Marcos as a reliable agent for both the Franciscan Order and the government of the Spanish territories. Who in his position would lie to the governor about seeing great cities and having hundreds killed in clashes? And who would willingly accompany a large army towards a nonexistent goal, knowing his lie would be discovered? It doesn't make any sense.

Fray Marcos reported to have claimed the land for Spain while on the hills outside Cibola, and he described erecting a stone mound with a cross placed on top. In 1926, an inscription in rock signed by Marcos de Niza was discovered in the South Mountain park just to the south of modern-day Phoenix. It has been declared a forgery although it cannot be proven one way or the other. Forgery or not, on the summit of a hill just west of this inscription four stone crosses were also discovered and were regarded by the Yaqui Indians as a sacred shrine ... and Fray Marcos had also stated he erected crosses along his way through that fateful land — as one would expect of a representative of the church.

There is much more to the story, and the fascinating, detailed account of Fray Marcos is reproduced in *The Lost Cities of Cibola*, along with many more pieces of this intriguing puzzle, including solving some of the mysteries of Easter Island! This is an important book exploring the borderlands in an objective fashion. But let us continue...

## CITIES OF THE DEAD

Certainly there is evidence that cities really were flourishing around Phoenix in the mid-16th century. The ruins of an earlier civilization still exist in the area, including traces of a vast irrigation system of canals utilizing both the Salt and Gila rivers. But the ruins indicate an age of many centuries before Estaban met his fate, their age is generally accepted as around 1100-1300 (although with a generally anomalous dating of relics found in excavations), and the vast canal system is dated as even older, as the canal mouths lay 18 feet above the level of the Salt River indicating an erosion date of some 1800 to 2000 years previous.

The ruins are attributed to the mysterious 'Hohokam', a Pima Indian word said to mean 'those that came before' or something to that effect. Strictly translated it means men (*hoho* is plural of *ho*, man) dead (*kam*). They were cities of dead men when the first Europeans began trickling into the area — over 150 years after Fray Marcos' first expedition — and there were skeletons found still lying amongst the smashed ruins, ruins said to have had "moulded door frames" and "polished smooth walls".

In 1888 the San Francisco *Examiner* ran a lengthy news story

headlined 'The Seven Cities' describing their location in the Salt River valley and describing the great size of these multi-storied 'pueblos' and the 'Great Houses' said to be the temples of the ancient priesthood. The reporter also speculated upon the age of the skeletons found in the ruins.

It is this question of dating which is the fundamental problem in claiming these ruins as the lost cities of Fray Marcos, and yet early descriptions of them match the monk's report. We are left with the conclusion that some extraordinary event must have happened between 1539 and the late 1600s that utterly destroyed the Cities of Cibola, leaving no trace of their earlier grandeur, whilst skewing the evidence beyond any rational archeological examination!

So what could have happened?

Richard Petersen, is a retired engineer with a Ph.D. in physics from Berkeley who has examined this puzzle very closely for many years. He suggests in his book that the cities of Cibola were suddenly and completely destroyed by some enormous catastrophe. An earthquake had been suggested by early investigators, given the description of shattered walls and crushed inhabitants, leaving what was left to rapidly deteriorate. Casa Grande and Pueblo Grande are about all that is left of vast ruins. And yet an earthquake cannot account for the peculiar geography/topography of the Phoenix city area, the bizarrely twisted rocks of Papago Park, which is high ground on which no ruins or ancient artifacts can be found.

Instead, Petersen gives another extraordinary and compelling scenario — that perhaps a comet or part of the tail of a comet hit the earth (perhaps the great comet of 1680 he suggests) and the mysterious hills around Phoenix, seemingly melted and then suddenly frozen, define its impact path. In his book are many detailed photos of the rock flow patterns showing that there was a momentary 'event' which left mountains (literally) of evidence which cannot be explained by orthodox means.

While in Phoenix recently we visited these hills with Mr. Petersen and came away convinced — from what we saw with our own eyes — that no conventional hypothesis can account for the appearance of the rocks. We especially noted how the northwestern path of the 'event' hit the 'head' of Camelback Mountain. The surface of the 'body' of the camel is of a much different character, and in stark contrast to the melted and twisted rock of the head. Whatever the 'event' was, it deposited a tremendous amount of material onto the land. This material is postulated to have dammed the Salt River long enough to build up a tremendous head of water which scored the river channel deeply. *Lost Cities* contains a detailed hydrological analysis of the ancient canal network which reinforces this suggestion.

## THE SKY IS FALLING

Mr. Petersen feels that the documented evidence collected by Charles Fort on mysterious falls from the sky — from fish to slowly descending rocks — suggests that there may be some gateway into another dimension above the surface of the earth, and that by viewing all the evidence we must come to the conclusion that a massive connection with this other dimension will fully account for the great mystery of Cibola.

Arizona is no stranger to heavenly falls. If one considers the

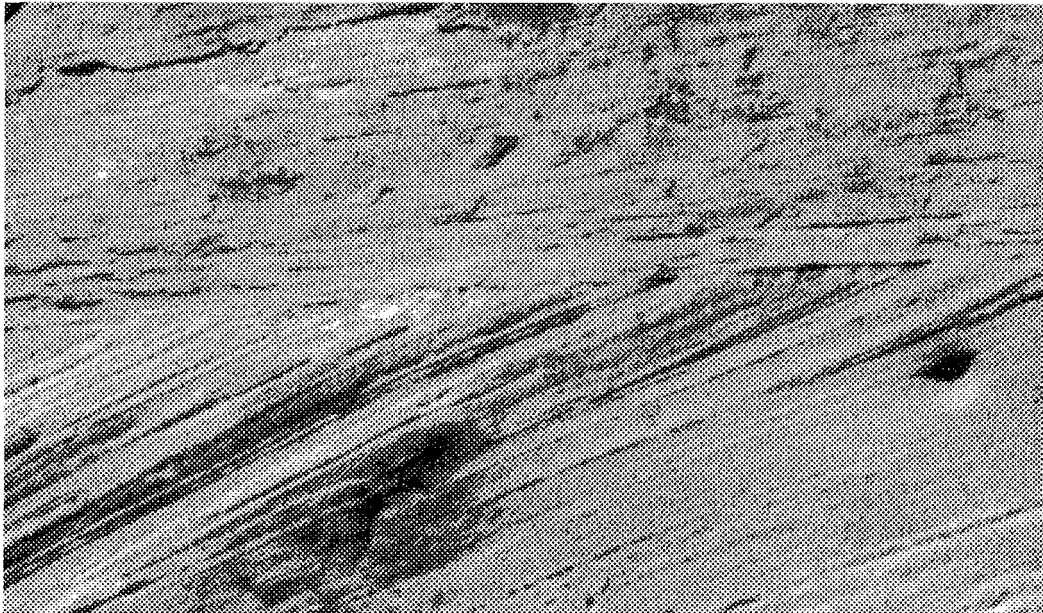

Close-up of crossbedded sandstone in Canyon de Chelly, Arizona. Note curious juncture of what would be considered yearly strata, but due to angle and sharp cutoff is alleged to be "petrified sand dunes". Can anyone show us similar stratification and junctures in "un-petrified sand" dunes existing in our present day?

vast motions supposedly taken by the sun and planets through space, it would be quite a coincidence for meteors to fall in the same place over and over, the regular meteor showers notwithstanding. Yet many meteors have fallen in the same places in Arizona over the millennia. Iron Valley in Arizona received its name due to the persistence of meteoric falls in the area. In fact, Arizona receives one of the largest percentages of meteors on the surface of the planet.<sup>2</sup> Can meteors be classed into these extradimensional events? The synchronistic character of the fall locations indicate that possibility.

It has been shown through charting events, such as unusual falls of rocks, fish, ice, etc., unusual energy phenomena, weird noises, unusual archeological finds, ... ) that they happen with a measurable periodicity when charted against both the calendar and upon a map.<sup>3</sup>

### MYSTERY SOILS

To help understand these extradimensional events Mr. Petersen give us an educational on the *loess* soils which cover large areas of the planet. The loess is an undifferentiated (non-stratified) silt that ranges from inches in depth to over a mile. The vast *Hwang Ho* (Yellow River) drainage of northern China consists of a very thick layer of loess deposits. The origin of the loess is an acknowledged mystery. It was once thought to have been deposited by wind as glaciers melted at the end of the ice ages, but of course, it being undifferentiated, this blows the gradual deposition theories. The loess apparently was dumped from above in one event. The latest orthodox scientific theories on the loess lean towards a meteoric origin!<sup>4</sup> But there are problems with that theory: as such a mass dropping from space would severely alter the landscape it landed, crushing mountains and plains. But in China, for example, the deposits lay across the land as an extraordinarily massive snowfall would, indicating a slow descent. The only fossils in the loess are a few small mammals at the extreme base of the deposits. However, snails

appear at random places throughout the loess! Mr. Petersen showed us some of these which he dug out of the loess around Council Bluffs, Iowa in past years, and pictures them in his book. These are not fossils, but snail shells completely filled with the loess in which they are imbedded. All in all, the loess presents us with a problem of great magnitude — extremely fertile organic soils supporting large populations, which may have come from a nearby dimension, or density, of space!

The loess presents a related problem to the mysterious melt path of the 'event' which wiped out the great Cities of Cibola. And this should get anyone

thinking about the general mystery of stratification in the desert canyons. Of course the story we are supposed to believe tells us that the layers were laid down year by year, over many hundreds of millions of years. This appears to make a certain amount of sense at face value. Look beneath the surface and all sorts of problems emerge. First off are the rhythmic sedimentations (like limestone, shale, coal, clay) and cyclothem (repeated layers of rhythmic sediments). These rhythms take place over large areas up to thousands of miles long, so cannot be explained by a chance localized event. Thousands of cycles of rhythmic sedimentations, accounting for millions of "years" of stratification appear in various strata found in the American deserts.

Secondly, we have mysteries of coal "sediments". Veins of coal have been found wending their way through a great many "years" of sedimentation, thus seriously damaging the theory that the coal is transformed organic remains — the "fossil fuel" theory. The fact that organic fossils, and footprints of ancient beasts, are found in coal seams indicate that the coal may be of a different origin than the organic life of the time. And at some places on earth there are multiple layers of coal seams, over 100 layers piled on top of one another in some places, interspersed with various other strata. The masses of vegetation alleged to have caused these must have been phenomenal, with some of the "compressed" coal layers over 250 feet thick. And we must ask, from whence the repeated appearances of the great masses of stone "sediment" layered with the coal?

And of course there are the missing layers! 35 million years missing in Canyon de Chelly. Not far away to the south there are 60 million years of sediment missing, or what is soberly termed a "period of non-deposition and erosion" or a "hiatus". The missing layers are not consistent at all, even in the geologically small area of Arizona.<sup>5</sup> And the layers have been allegedly deposited from older rock which, for the most part, is below the strata, unless upthrust due to some other type of indeterminate geological event.

There are inverted layers upon occasion, but this is explained as a "folding" of the earth during some unexplained geological event. It has been suggested that the stratification was caused rapidly when the moon split off of the earth, (if indeed it split off) because on the first few orbits the pull of gravity was so great that it warped earth's surface.<sup>6</sup>

We cannot neglect the puzzling "cross-bedded sandstone" such as is found in Canyon de Chelly and elsewhere in the canyons of the Four Corners region. Crossbedded sandstone appears much like any other stratified sandstone, except the layers run at an angle within thicker, horizontally stratified layers. If straight, the layers would be counted as year-dated strata, but they are an extensive pattern and the horizontal breaks are clean, leaving puzzles to ponder. There appears no logical way to explain these patterns as yearly depositions so we are treated to the questionable "petrified sand dune" theory. One look at Canyon de Chelly is enough to wonder how in the world anyone could come up with "petrified sand dunes". This theory is soberly presented in most books on geology dealing with desert canyon strata. We admit the inability to arrive at a rational explanation of what we have seen. In one canyon we explored in southeastern Utah, there were alternating 8-10' layers of red and white crossbedded sandstone, with an occasional mottled red and white layer. From whence came these patterned 'sediments'?

The crossbedded sandstone is a great mystery in itself, a mystery within the greater mystery of the origin of the earth itself.

In a previous desert expedition article<sup>6</sup> we explored the "canopy theory" in which is hypothesized that a "canopy" once surrounded the earth, and which gradually fell to earth, causing first stratification as the rock cooled from planetary formation, then much later, on to the final falls of water resulting in the records of the ice ages and legends of the "flood of Noah".<sup>8</sup> The canopy theory is an interesting working hypothesis and much evidence supports it, but it is not a complete picture. Perhaps if we consider that the "canopy" were somehow extradimensional, beyond the borders of our physical perceptions, we can begin to build a picture in our imagination.

That there has been a progression recorded in strata, from single cell organisms to early mammals, we cannot deny. But we have no exact evidence that this has been a gradual process. Rather it appears to have moved in steps, with millions of tons of rock defining the steps. It appears that with these thoughts we touch upon the life process of the very planet itself.

### **PETRIFICATION**

What is the cause of all the petrified wood, those silica based logs of mystery laying about. The standard theory is that petrification is a slow process, caused after a cataclysmic "event" felled the trees and buried them in mud. Of course this would certainly not explain the still standing petrified forest in Tierra del Fuego, Argentina<sup>9</sup>, or the petrified trees found poking through thousands of "years" of layers in coal seams. Nor does it explain the Bisti and De Na

Zin Wilderness badlands, near Chaco Canyon in New Mexico, where the very tops of the weirdly formed cliffs are laced with giant petrified trees and dinosaur bones. Extremely well worn semiprecious silicates form many horizontal strata interleaved with bentonite beneath the cliff tops. At the base of the draws and washes are extremely hard conglomerates of white sand, the sand still squared and sharp, but mixed with more of the worn and crushed silicates. Above that are 10' or so layers of undifferentiated gray bentonite with no stones within, then a foot or so layer of the worn stones, and then these last two layers repeat up to the petrified tree cliff tops. Wandering these bizarre and beautiful wastelands one can only wonder as to who came up with those curious stratification theories? They certainly don't fit what the eye can see, and we came away with more questions than answers.

### **THE PEOPLE**

The desert hides its secrets with infinite patience. The casual visitor sees only a harsh and forbidding terrain, an emptiness that seems to mirror the void within the human soul when the links to our ancient history are forgotten or destroyed. But for anyone who strays beyond the highways and boundaries imposed by the modern world, the mysteries of the desert begin to reveal themselves, slowly, layer by layer...

While the great cities and monuments of the stone builders still exist side by side with modern architecture in other countries imbuing the people who live there with a sense of continuity and connection with their ancestral past, here in the southwest only fragments remain of the great centres that once teemed with life and activity. Little remains of the Hohokam who built largely of caliche, or adobe, leaving little trace of houses once smoothly plastered and colorfully painted.

Despite all evidence to the contrary the official story would have us believe in a primitive race, displaying images of half-naked savages toiling in the heat despite reports of the early Spanish explorers who were impressed by the fine quality of the woven garments worn by the Indians, and the large quantity of their beautiful jewelry.

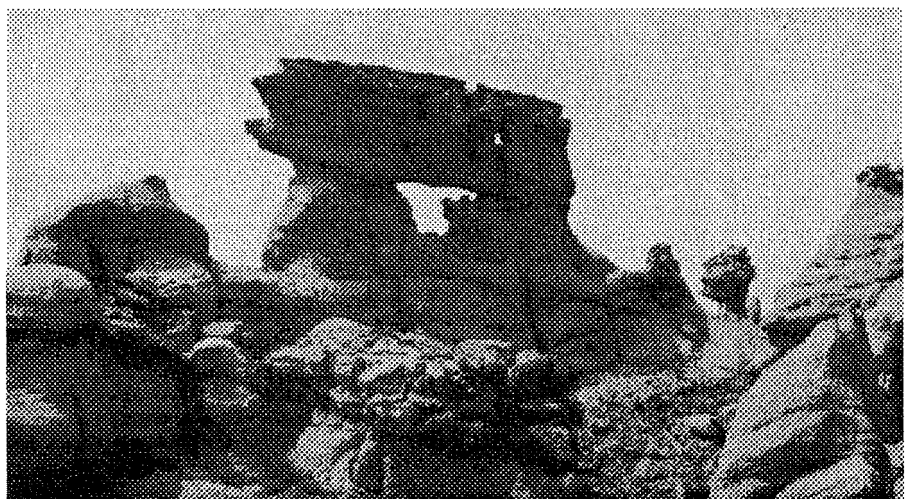

Petrified tree merged with sandstone atop the badlands of De Na Zin Wilderness, New Mexico. The highest points are petrified logs!



C a s a Grande, just south of Phoenix, is the tallest and most massive Hohokam building still standing, it contained nearly 3000 tons of caliche and is still impressive today. Openings in the walls align precisely with the solar equinoxes and solstices, and the lunar cycle, showing an intimate connection between the people and the cosmic seasons. Their architecture expressed this natural harmony — an alien concept in our age of ugly glass and steel cities.

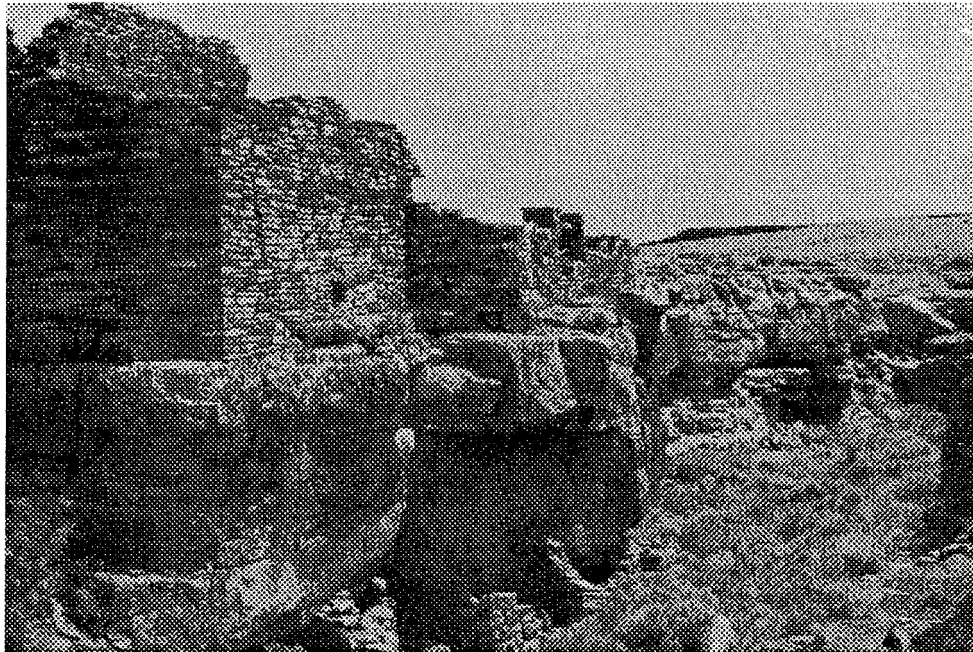

Architecture merges with landscape in the scattered ruins left behind by mystery civilizations in the American Southwest. These are Box Canyon Ruins, Wupatki National Monument, Arizona

While the adobe structures have weathered away over the centuries the ruins of the Anasazi further to the north are better preserved being built mainly of rock and stone bricks. They cover a vast area, puzzling evidence of a civilization that flourished around the same time as the Hohokam, yet had a distinct character of its own.

White House Ruin at Canyon de Chelly is an Anasazi ruin at the base of immense canyon walls, a multi-storied pueblo reaching up to more rooms in a cave above. It has similar stonework to Chaco Canyon, the heart of the Anasazi culture. The Navajo still live in the tranquillity of the canyon, disturbed only peripherally by seasonal swarms of gawking tourists.

While kivas—the circular stone structures—are a prominent feature of the Anasazi, they are noticeably absent from the Hohokam and Sinagua pueblos. Just northeast of Flagstaff, Arizona, we visited Wupatki National Monument, site of several ruins attributed to the Sinagua, yet another civilizations that coexisted with the Anasazi and extended from the San Francisco Peaks area south into the Verde Valley. These pueblos seem to grow from the rocky outcrops of the canyons, they are so organic in appearance and so finely merged with the landscape.

Wupatki Ruin is the largest pueblo with multi-storied buildings and the addition of a large circular stone ‘amphitheater’, perhaps taking the place of a kiva, and nearby what is believed to be a ball court, also a common feature of the Hohokam pueblos, linking them directly with the ancient centres of Mexico and Central America.

From Wukoki Ruin, which rears like a ship of rock from the surrounding desert, one is in direct line of sight with the Hopi mesas, and the sacred San Francisco Peaks behind. From here the vast territories of these ancient people unfolds into the distance

and the mystery of their origin, and their sudden disappearance impresses itself upon the imagination.

One of the greatest archeological enigmas is how, within only a few centuries, the primitive pit-house builders suddenly acquired the urge and ability to create fine pottery, huge multi-storied centers, an extensive high-way system (Anasazi), or a vast irrigation

complex (Hohokam). Was there an influx of ideas and people from Mesoamerica, or was it an impulse transmitted from the earth itself? Who really were the builders of the Lost Cities? Despite all the scholarly interpretations available, the time and origin of their ‘emergence or arrival’ remains another of the desert’s well-guarded secrets.

As the dry and dusty earth blooms suddenly and briefly with the brilliant color and exotic perfume of wildflowers in the spring, so the ancient dwellers grew and flourished within a greater cycle of nature. Although their season has passed, the seeds of their knowledge remain hidden in the rock where they lived, leaving us only scattered pieces of puzzling evidence ...

#### REFERENCES

1. **The Lost Cities of Cibola**, Richard Petersen, Ph.D., G&H Book, 2515 E Thomas Rd, Suite 16, Phoenix, Arizona, U.S.A. 85016
2. **The Inexplicable Sky**, Arthur Constance, T. Werner Laurie Ltd, London, 1956
3. **Space-Time Transients and Unusual Events**, Michael Persinger & Gyslaine F. Lafreniere, Nelson-Hall, Chicago, 1977.
4. **Unknown Earth: A Handbook of Geological Enigmas**, William R. Corliss, Sourcebook Project, Glen Arm, Maryland.
5. **Roadside Geology of Arizona**, Halka Chronic, Mountain West Publishing Co., Missoula, Montana
6. **The Moon Puzzle**, N.O. Berquist, BSRF Reprint, 1992
7. *Journal of Borderland Research*, March-April 1992, Shadows of the Ancients, Davidson & Brown
8. **Those Astounding Ice Ages: An Exploration of Our Planet’s Most Challenging Mysteries**, Dolph Earl Hooker, Exposition Press, 1959; BSRF reprint, 1992.
9. **Argentina Turistica**, Editions Delroisse, Paris, France



*The toxic effects of lead on man have been known for a long time, saturnism being one of the first industrial diseases to be recognised.*

E.E.C. directive on lead in petrol, 14 December, 1973

In 1952, Kolisko's *Saturn und Blei* was published. It described the connection between lead and Saturn from various points of view — chemical, geological, industrial, historical, alchemical, astrological and astronomical. In the second part of the book, some fifty experiments were described, performed over celestial events, most of which involved Saturn between the years 1926-1951. Illustrations showed the changes which occurred in filterpaper pictures over these events, in which lead and other metal salts were used. This work was done and the book written in Stroud, Gloucester. It received no recognition. Dean's description of Kolisko's achievements as 'pioneering and monumental'<sup>1</sup> surely applies to this work.

# Lead, Saturn & Saturnism

by Nick Kollerstrom

I would like to look at some of the diverse ways in which lead is used nowadays and its properties. I hope that in such a description its Saturn-like nature will become evident.

Saturnism was one of the first occupational diseases to be discovered, and today medical experts discussing lead poisoning still refer to it as 'saturnism'. Was it so named because the symptoms of lead poisoning — headaches, fatigue, depression, etc. — seemed reminiscent of a 'Saturnine' humour? It is a fact that if small amounts of lead are ingested regularly there is a tendency for a melancholy mood to develop.

Lead comes to us mainly from motor vehicles. Until recently, thousands of tons a year of lead were pumped into the air from car exhausts and sprinkled around areas of human habitation. It is put into petrol in order to slow down, to retard its combustion in car engines, to make sure that it ignites at just the right time.

Blood levels are measured in tenths of a part per million — a quite homeopathic dilution. If the blood lead level goes up by only just a few tenths of a part per million

then there is the danger of lead poisoning. A daily dose of a few thousandths of a gram can be toxic, especially for children. Children are especially unable to protect themselves from this 'old-age' poison, lead. There now exists disturbing evidence that the intellectual ability of some children is being inhibited by lead; a survey of Manchester schoolchildren showed a distinct negative correlation between body lead content and I.Q. Here lead exerts a slowing down influence: the mind's proper mercurial mobility is slowed down by lead. This effect is not reversible: a chronic problem, indeed (Chronos, Old Father Time!).

It has been shown by more than one study that stillborn foetuses have a considerably higher lead content in them than do live births<sup>2</sup> (Chronos devouring children?). Professor Bryce-Smith described this finding as 'only the tip of the iceberg' as far as the effect of lead on the populace was concerned. It is ironic that in America lead has been removed from petrol because of its poisonous effect on something quite inorganic — the catalytic afterburners fitted to their cars!

City lead levels may even affect the duration of human

lifespan.<sup>3</sup> Evidence for this is from the remarkable experiments by Schroeder, who found that rats fed on a diet containing five parts per million of lead had their lifespans shortened by as much as 25%. Typical lead levels in city dust in this country are around 1000 times this concentration.

Lead stores in bone tissue. If you could see only that part of the body where lead was concentrated you would see — a skeleton.

Lead stands as a boundary or limit of heaviness for matter. Elements of atomic weight higher than that of lead are too heavy to be stable, they must continually disintegrate in radioactive decay. This can be seen in a modern Periodic Table of elements, where the elements are arranged in an order of increasing heaviness. Metals with an atomic weight higher than 207, that of lead, must undergo decay (I am not here including the semi-metal bismuth). So lead is a boundary for matter beyond which it acquires a new property, a property involving time: the time which it takes to turn back into lead.

Scientists use lead for measuring time, but only the very long aeons of time, such as the age of the earth. Extra-heavy elements such as uranium are always decaying, breaking up into lighter elements, until eventually they become an isotope of lead. Then, this decay process ends — lead is its natural limit. For this reason no element has so many naturally occurring isotopes as lead. In a sample of rock containing uranium, lead will also be present, in proportion as the uranium has decayed. The more lead present, the more age! By measuring exactly the ratio of uranium to lead in such rocks, scientists will soberly infer billions of years of the earth's age.

Uranium, the first metal heavier than lead to be ascertained, was discovered in 1798, soon after the discovery of Uranus—the first transsaturnian planet—and was named after it. One could say that a lead-Saturn limit was then passed. The disruption of accepted notions which ensued from investigating the properties of uranium hardly needs emphasizing. Today, nuclear power plants are shielded with lead, again reminding us of its connection with these extra-heavy elements.

Why does a car battery need to be so heavy, with so much lead in it? No other kind of battery would have the right time-properties, such as being able to deliver power over days without any change in voltage, unvarying; or be charged up over days then to give out that power in seconds. Here the inertia of lead is important; it is able to remain in the sulfuric acid for days without any reaction taking place, and only react when an electric current passes. Other batteries use two different metals, but in an accumulator the lead works alone, surrounded by acid.

As a heavy, dark, sluggish metal, it was traditionally the basest of the seven. Of the seven metals it is the slowest

conductor of electricity and the least lustrous or resonant. No other metal tends so much to form insoluble compounds—an aspect of its heaviness. Use of this metal in paint is now banned, but still there is no other white paint that can last through the years as one that is lead-based. I was looking at an old sundial the other day, wondering why it was made out of lead... Its more traditional uses include tombs and bullets.

Lead is used for painting the yellow lines along the curbside. Lead chromate here exerts a Saturnine function, prohibiting parking over intervals of time. As Saturn is depicted as holding an hourglass, so these lines of lead measure out the hours for which one may park a car. In such mundane terms can one visualise the axiom 'As above, so below' which alchemists of old attributed to the Emerald Tablet of Hermes. Imagination perceives what logic cannot easily deduce, that the function of these metals shows their planetary essence. California scientist Clair Patterson ascertained the age of the Earth by using lead isotope measurements, and this shows the same Saturnine essence of lead in action as does its use in painting roadside lines. Both cases relate to time measurement — one in hours, the other in billions of years!

### **The Great British Lead Debate**

A storm of controversy erupted in Britain in 1981, during the triple Saturn-Jupiter conjunction. The issue at stake was whether a generation of children had been brain-damaged by lead pollution. My small contribution was *Lead on the Brain* which emerged in 1982. A Jupiter-cycle after these events (i.e., twelve years later), some further comments are appropriate with a difference that the only figures here used will be celestial, not terrestrial. A triple meeting of two planets arises due to one going retrograde in an apparent backwards motion, which between Jupiter and Saturn normally happens once per century.

In 1980, Britain's Medical Research Council came out with its fairly uncontroversial view that existing levels of lead were no danger to public health, an opinion endorsed by more or less all scientific and medical experts of the time. During the 1970s I was employed by the MRC's Air Pollution Unit, which had the function of assuring the public that everything was O.K. and that the Government was looking into the situation, etc. Professor Lawther, who was the Unit's head at the time, came out with an estimate of the contribution of car exhaust to our daily lead intake, giving what can now be regarded as an absurdly low level. His figure was widely quoted in Britain's House of Commons and Lords as an apparently firm basis for government inaction over lead in petrol.

When 'The Lawther Report' on the subject emerged, in March of 1980, Professor Lawther was undergoing his

second Saturn-return, at two degrees of orb. His Report represented an unholy alliance between petrochemical industry and government experts, to the effect that the vast quantities of lead put into petrol every year were quite safe. The only Saturn-aspect in Lawther's natal chart was a solar opposition, which hardly expresses a working with its energy. In fact the lead issue wrecked his career, with his resignation from the Medical Research Council at the end of 1981.

When I was at the Air Pollution Unit, claims that car lead exhausts were brain-damaging a generation of children could be viewed as emanating from just one source, namely Professor Derek Bryce-Smith, chemistry lecturer at Reading University. The media always linked his name to the issue. Figure One shows his astrological chart. By any standards it has an extraordinarily powerful Saturn, with no less than seven major aspects. That is the focus of his chart, and it was being activated by transiting planets while his challenge to the experts was published. A 'transit' means that a planet in the sky passes over some sensitive point in the natal chart.

In December of 1980, *Lead or Health* was published, co-authored by Bryce-Smith and Stevens, a rebuttal of the Lawther Report.<sup>4</sup> Its publication chimed with the first of the three Saturn-Jupiter conjunctions, marking the beginning of a David and Goliath confrontation. Not many copies of this work were printed, and it was sold from a private address, receiving no reviews from scientific or medical journals, but

it exerted a catalytic effect on the whole debate. It mapped out the full horror-scope of lead's effect in the modern world, concluding that an estimated five-point reduction in I.Q. had been caused among the younger generation, sufficient to double the number of mentally subnormal cases in our society.

In the triple conjunction, Saturn represented not just a metal, but also I suggest the inertia of established science. In January 1981 the British Medical Journal reviewed the Lawther report, endorsing its views and dismissed Bryce-Smith's view.

In the last week of February 1981 the Australian government announced its decision to switch over to lead-free petrol. Its decision was stimulated by a study of a thousand Sydney schoolchildren in 1979, which found antisocial behaviour and ill-health correlated with blood lead levels, such that 'whenever antisocial or delinquent children were encountered, they had raised blood lead levels', which was 'an alarming situation of epidemic proportions which should receive urgent and detailed attention at the high-

est government level...' One is reminded of the words of Rudolf Steiner, that 'When we introduce lead into the human organism, we place it directly amidst the process of world-disintegration'.<sup>5</sup>

The Australian report concluded that car exhaust was the major source of our daily lead, a view that was being strenuously denied by British government experts. An Australian government brochure explained how their new

Fig 1. Chart of Professor Derek Bryce-Smith

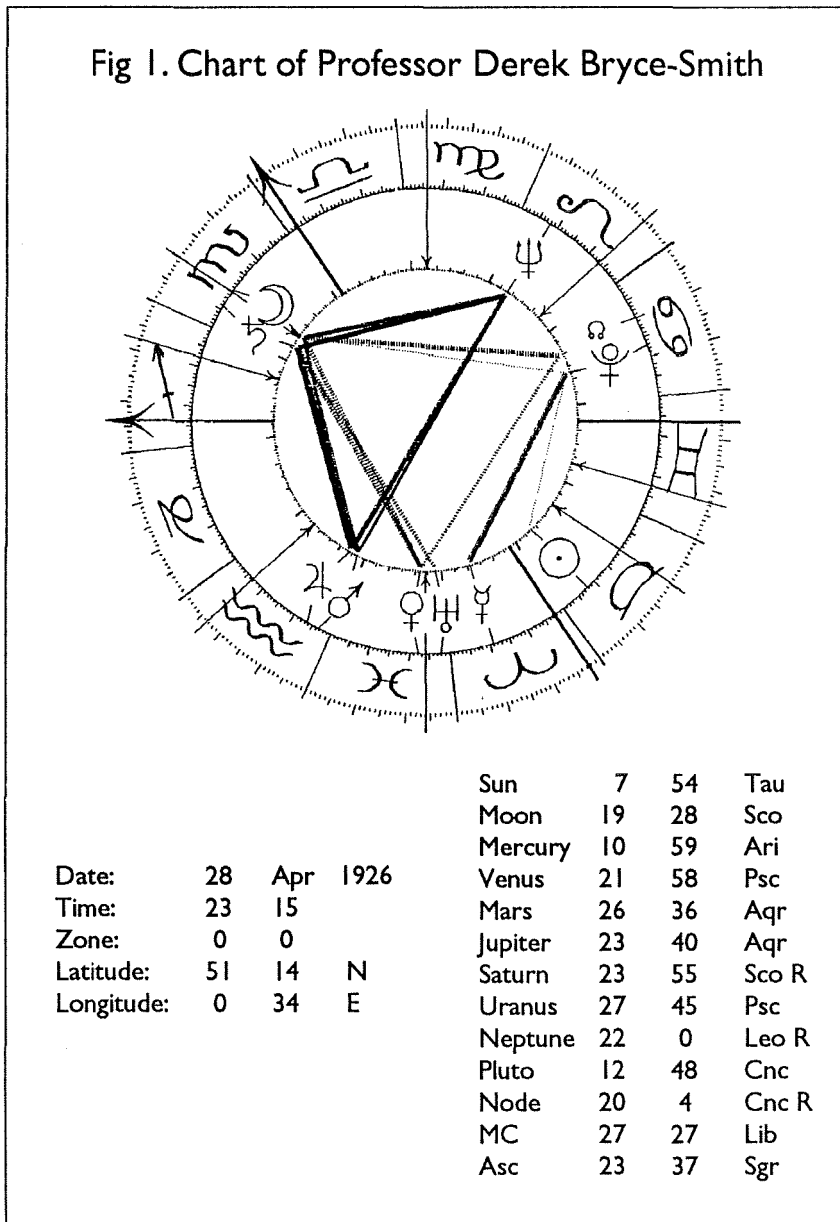



decision would lead to a net energy saving, as cars would run more economically on lead-free petrol. British government experts had been intoning gloomily about the cost of the extra oil required if lead were removed as the vital anti-knock agent. Britain was, and still is, the world's number one exporter of tetra-ethyl lead.

Two members of the Lawther Report's Committee decided to conduct their own investigation into the link between blood lead levels and school performance. Embarrassingly, they found that all measures of school performance correlated inversely with blood lead levels, and that most measures of antisocial activity in the classroom were linked to blood lead level. This 'Yule-Lansdown Report' as it became known found a seven-point I.Q. difference between their high and low blood lead level groups, and that was after allowing for effects due to social class. The British Medical Journal declined to publish it, but its authors were too eminent to be ignored. There was nothing new about these findings, but it was innovative that British scientists had done such an experiment. Rumours of their findings ran through Whitehall.

In March 1981 the U.K. magazine *Doctor* declared in its editorial that:

Before the Government makes any decision about the permissible level of lead in petrol, the Department of the Environment must publish the results of the latest MRC pilot study.

It didn't. On March 6th, the Department of Health's Chief Medical Officer Sir Henry Yellowlees sent a historic letter to civil servants, admitting 'There is a strong likelihood that lead in petrol is permanently reducing the IQ of many of our children', and that 'action should now be taken to reduce markedly the lead content of petrol in the United Kingdom'. The letter wasn't made public, but accounts of it were leaked.

In March the ILEA (Inner London Education Authority) published a report concerning the health of schoolchildren, much influenced by Bryce-Smith's opus. It was very different in tone from previous reports on the subject, and admitted that safe levels of lead in the dust of school playgrounds, for example, could simply not be met.

That month was surely the pivot of the whole debate, over the second of the three conjunctions, when the official consensus cracked asunder. On April 4th 1981, an editorial in the *Observer* remarked that

The Department of Health and Social Security, in an astonishing about-turn, are now seriously alarmed and say that hundreds of thousands of our children are at risk of brain damage — a figure which may well be an underestimate.

Oil, lifeblood of the modern world, was poisoned, contained a deadly brain poison. This was no longer just your or my paranoia but now an admitted scientific fact. A few drops of tetraethyl lead literally could cause death, indeed was rumoured to have been used for such by the CIA, on account of its readiness of absorption through the skin and difficulty of detection. The Russians who banned the substance decades earlier were said to have done so from their knowledge of this matter (by way of comparison, all poisonous herbs in Culpeper's Herbal are assigned to Saturn's rulership).

Associated Octel is the U.K. company which manufactures tetraethyl lead, and nothing else. In April 1991, it was awarded the Queen's Award for Export, for the second time. That was the Government's response! In May the U.K. Government debated the issue in Parliament and announced a compromise decision to reduce petrol lead levels by two-thirds, starting in 1985. The third conjunction in August, with the two planets going direct again, was followed by the publication of the Yule-Lansdown report, negating the Lawther Report's conclusions by showing learning disabilities within the range of blood lead levels claimed to be safe.

During these events, Bryce-Smith was experiencing a Uranus-trine return (i.e., it stood at 120° to its position in the heavens at his birth), at the age of fifty-five. Like the Saturn-return, the Uranus-trine return can be vitally important in the life of a scientist, however it is normally the first of these which is significant. Both Lawther and Bryce-Smith, the two main protagonists, were experiencing the second of these returns. As lead/Saturn is related to old age this may well be relevant. Bryce-Smith's involvement in the subject began (he told me) in 1954, when he first comprehended the extreme toxicity of tetraethyl lead. He requested a small amount for an experiment, and an expert came round from Octel to interview him. There were questions such as, did he realise that if he spilt a few drops on the floor, the floor would have to be taken up? He pondered the spaceman-type protective clothing worn by workers in the organo-lead industry. This was the year of his first Uranus-trine return.

There was a powerful linkage of celestial events to Bryce-Smith's own chart over these crucial months of 1980/81. Uranus in the sky crossed over the position of Saturn in his natal chart, as Jupiter and Saturn in the sky opposed his natal Uranus. Figure Three diagrams these events, showing the aspects out to one degree of orb. (For comparison, Figure Two tells us that the triple conjunction never moved more than one degree apart over January — February of 1981).

Figure Three shows these transit aspects, in particular his Uranus-trine return which became exact in December. The strong transits to Uranus built up — this being the planet

which astrologers associate with scientific discovery — as his challenge to the experts appeared. Some years later, in 1984, he was awarded the Royal Society of Chemistry's Silver Medal in recognition of his pioneering work on lead toxicology, despite opposition from its industrial lobby.

Some readers may find the birthchart in Figure One puzzling, so let us consider its relevant features. The planetary aspects form a geometric pattern in its centre, and this expresses the energy of the birthchart. The line across the middle of the circle depicts an opposition, that is to say a 180° angle, linking Neptune (♆) with Mars-conjunct Jupiter (♃♃), and these are in turn linked to Saturn and the Moon by squares, i.e. lines spanning ninety degrees of the circle. The computer has drawn these aspects in strongly because they are 'exact', that is to say of small orb, the square between Jupiter and Saturn being a mere fifteen minutes of arc, or a quarter of a degree. An astrologer would regard this aspect as relevant to professor Bryce-Smith's deep understanding of the subject, and see the strong squares-plus-opposition configuration as conducive to public debate involving challenge and conflict. By contrast, the more harmonious trine of Saturn to Uranus has a four degree orb, drawn as a weaker line for a less exact aspect. The astrological symbols were given in chapter four, the only new symbol in the chart being ♁, the lunar node. The chart's outer ring depicts the zodiac, which doesn't here concern us, as neither do the twelve lines depicting 'house' divisions.

The chart represents a moment in time, in contrast with the other figures which depict celestial events unfolding in the course of a year. In these, the shading for each aspect extends to just a degree of orb, since that is roughly the size that astrologers use for transits. Figure Two shows the triple conjunction, while Figure Three shows the relation between key planets in Bryce-Smith's birthchart, and those in the heavens. The first planet given is 'transiting' and the second is 'natal'. Uranus passed over the main focus of his chart, its Saturn-position, in October of 1980, just as he was finishing his treatise.

FIG 2: THE TRIPLE JUPITER-SATURN CONJUNCTION 1980/81, to 1° orb

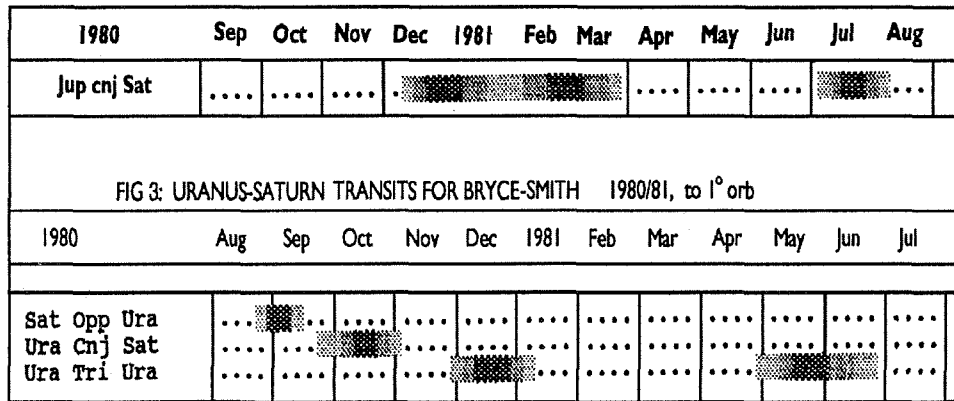

Studying such transits helps us to appreciate how one individual came to be a focus for historic events. This Hermetic approach helps to bridge the gap between the inner experience of the scientist and what they

achieved in public. Scientific writings tend to eliminate the psyche of the person who made the discovery as if it were a thing of no relevance, but we need to move beyond this attitude. This theme is further developed in the final section of this book.

Lead as a chronic poison has a half-life in human bone tissue of thirty years, which is Saturn's orbit period. Professor Herbert Needleman in the U.S. has done a follow-up to his classic study of classroom performance and tooth lead levels of the late 1970s, as the group of adolescents he examined reached the age for entering high school. Five years after the original study, the high-lead group were found to be more than seven times as likely to drop out of school, and tended to be a couple of years behind in reading ability,<sup>6</sup> compared with his low-lead group.

Hermetically speaking, a civilised society would be one that kept its gold above ground to glitter in the sunlight as befits the noblest of metals, adorning temples and places of magnificence, while in contrast lead, the basest metal, should as far as possible be left underground. However, it is also the task of a civilised society to press forward and not be bound by tradition. In this respect we note that lead, in its activated homeopathic form, is used as a treatment for sclerosis, the hardening which appears in the bones and arteries as a result of the Saturnine ageing process.

### References

1. G. Dean, 1977, p.60.
2. N. Kollerstrom, 1982, p.37.
3. A. Tucker, 1972, p.125.
4. D. Bryce-Smith and R. Stephens, *Lead or Health*, 1980.
5. Steiner quote: Pelikan, 1973, p.36.
6. Needleman: *New Scientist*, 13 January, 1990, p.26.

This article is excerpted from **The Metal-Planet Relationship — A Study of Celestial Influence** by Nick Kollerstrom published by Borderland Sciences Research Foundation. Publication date is September 21, 1993. ISBN 0-945685-14-9, \$12.95.

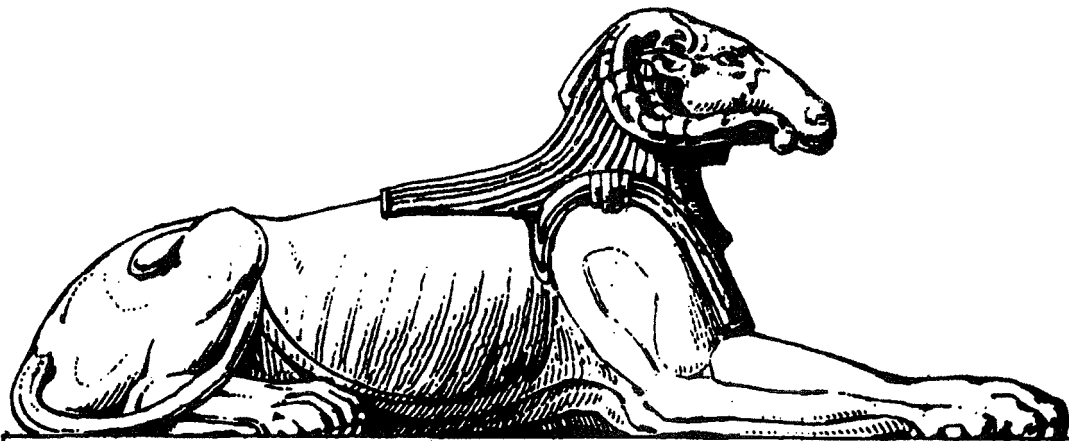

## THE PUNDIT CURMUDGEON

© 1993 E.D. O'Brian

There is a moral related to the existence of this epistle: if you write too many letters and proposed articles to the editor of the BSRF Journal you may end up writing a column. Be warned. Since I have agreed to write a column you, the readers, should have some idea as to the type of character who would pick a mark such as "Pundit Curmudgeon" to designate it. The words in the mark give valid clues as to his nature.

The "curmudgeon" part of the mark is easy to explain. At least to some it conveys the concept of being bad tempered & cantankerous about many aspects of the current tangible world and many people and social institutions within it. Hence, it fits as a "family" name for the type of recurring characteristics which, hopefully, the column will have.

"Pundit" indicates someone who is or who acts in an authoritative manner. In the mark "Pundit Curmudgeon" it acts more or less like a first name suggesting an authoritative character reacting to the justifiable anger and frustration inherent in the world as society commonly considers it to exist. If the column is to be read it has to at least give the impression that it is based on valid knowledge and logic.

As a reader of *Borderlands* you at least question and probably are fed up with the way many persons and civilization as a whole proceeds with dark glasses and side blinders protecting closed minds from recognizing that there is more to existence than is acknowledged by established religion and science. Both would have us ignore anything not in conformity with their tenets, perhaps in the hope that if something is neglected that in time it will disappear.

Before my retirement as a patent lawyer having a chemical engineering background I accumulated frustrations on frustrations by dealing with social and religious hypocrisy, the Patent and Trademarks Office and our judicial system which caused all sorts of consequences. These included the usual tension and stress-caused physical complications. For unknown reasons the frustrations also gradually encouraged an interest in about everything capable of being easily understood which established authority seemed to ignore or overlook.

Now that my burdens of representing others are past it is possible to be mentally free and unfettered by concern as to possibly violating a client's confidence. Wheel! Don't get ideas about ever contacting me as an attorney or as a patent lawyer or of disclosing anything to me on an express or implied secret or confidential basis or for any form of advice. Nothing sent to me from any reader will be held or treated in a secret or confidential manner.

My interests in neglected, forgotten or socially "reject" knowledge resulted in my accumulating various "unusual" collections relating to what probably should be called "scientific" and "religious" matters,

particularly as the two are related under the often abused heading "magic". Isn't all science magic? Isn't the basis of common religious belief a belief in the magic of a particular faith? Dealing with these terms so as to avoid a lynching will require lexicological skills and hair splitting logic beyond human ability — but it will be fun trying to deal with them in the column.

Some of these collections are on usually debatable topics. This is particularly the case with those accumulations on permanent magnet type motors and psychographs. Both probably will be published in time. Expect these subjects in this column whenever I don't know what to write about or am pushed for time. On occasion the column will cover legal and patent matters of general concern; frequently it will attempt to relate past learning with today and tomorrow.

For the most part this column will deal with questions. A prime one of these is why recognized "science" refuses to recognize that the scientific method is only completely reliable when applied to a static "system"? The reproducible, consistent results required for something to be accepted under the "scientific method" cannot be achieved in a dynamic system in which any change is entirely beyond any form of traditional direct or indirect human control.

If no one else has previously stated this for the purpose of flattering my abused old ego let's call it "O'B's Principle #1". It has applications we normally would not consider but which will be debated in the column. One such application is in the field of legally recognized medicine. Because of this principle common medicine, particularly as it concerns the use of drugs, can never be regarded as a traditional science in which results can be accurately predicted in accordance with what is technically the "scientific method".

Traditional thinking gets around this technicality by holding that something can be "scientific" if its use will give predictable results a reasonably consistent percentage of the time. This expansion of the term "science" is employed even in those situations where no one has a complete explanation as to why expected or any other results are achieved. The explanation required in this type of circumstance is different from the scope of the partial knowledge society has about many common topics such as the nature of gravity, magnetism and other items.

Unfortunately this column will normally have to be based on partial knowledge and speculation relative to whatever is being discussed. Hopefully both you and I can do this while enjoying relaxed fun as I shed the false dignity involved in writing patent applications and related "legal" documents. And hopefully through the column those topics discussed will increasingly become better understood until they follow the path of many things and graduate from being social pariahs to the category of "established" knowledge which is accepted by virtually everyone.



In a sense perpetual motion is like obscenity. After acknowledging the complications and problems in trying to accurately define "obscene" some individuals have espoused that it is not necessary to define it since everyone knows what it is. By this type of logic it should not be necessary to define perpetual motion since everyone believes that she or he knows what it is. But does anyone really know what perpetual motion is or how it should be defined? Where is the dividing line between items which do and do not fall into the perpetual motion category.

This improperly compound question and this column are consequences of an article on page 4 of the July 1, 1991 issue of the American Chemical Society's Chemical & Engineering News (C&EN). This discourse relates to an intriguing "Molecular Shuttle" which, in the interest of avoiding chemical terminology, can be considered as a long bar, a coil spring at each end of the bar and a block movably mounted on the bar so that it will bounce back and forth between the two springs in response to a minimal heat. Presumably it will act in this manner until the end of time or until the complex compound constituting the shuttle breaks down.

Is such a chemical monstrosity an example of a perpetual motion type contrivance or isn't it? Is it a "machine"? The article repeats the statement (p.5): "*The idea that you could exploit these molecules to couple electrochemical or photochemical energy with mechanical changes is really quite intriguing.*" Does this change your views as to whether or not the chemical structure involved is or is not in the perpetual motion field?

In mulling over possible answers to these questions you should recall that one of the major breakthroughs in chemistry was Kekule's realization that a benzene ring was not a static structure under normal ambient conditions but instead was a "dynamic" composition in which electrons constantly shuttled back and forth on opposite sides of the carbon atoms —

apparently without any application of any non ambient external energy. Perhaps you might also want to think about Brownian movement. And then you could also consider the movement of electrons about the nucleus of an atom before getting into gravity, the world and the solar system.

These and many other items are examples of continuous activity or motion which has gone on from an unknown ancient date and which are expected to go on for an indefinite period in a probably unlimited future. Whether or not they are in the "perpetual motion" category depends upon how you would define this term. For definitions in accordance with "standard" usage it is necessary to consult those oracles of wisdom known as dictionaries.

In the USA probably the most authoritative current dictionary is the 2nd unabridged edition of the Random House Dictionary of the English Language, copyright 1987. It defines "perpetual motion" as: "*Mech. the motion of a theoretical mechanism that, without any losses due to friction or other forms of dissipation of energy, would continue to operate indefinitely at the same rate without any external energy being applied to it.*" Two of the several "key"

words in this definition - "Mech." and "mechanism" - are effectively, but not completely, omitted from the definition in the more authoritative and detailed Compact Edition of the Oxford English Dictionary, copyright 1971. The latter defines "perpetual motion" as follows: "*.. motion which goes on forever, spec. that of a hypothetical machine, which being once set in motion will go on forever, or until stopped by some external force or the wearing out of the machine.*"

Surprisingly neither of these definitions even suggests a debate as to whether or not "perpetual" in "perpetual motion" means an indefinitely long period of time or forever. Although as a practical matter both meanings of "perpetual" are the same, from a philosophical viewpoint the meanings are quite different.

## DEFINING PERPETUAL MOTION

DEFINING PERPETUAL MOTION

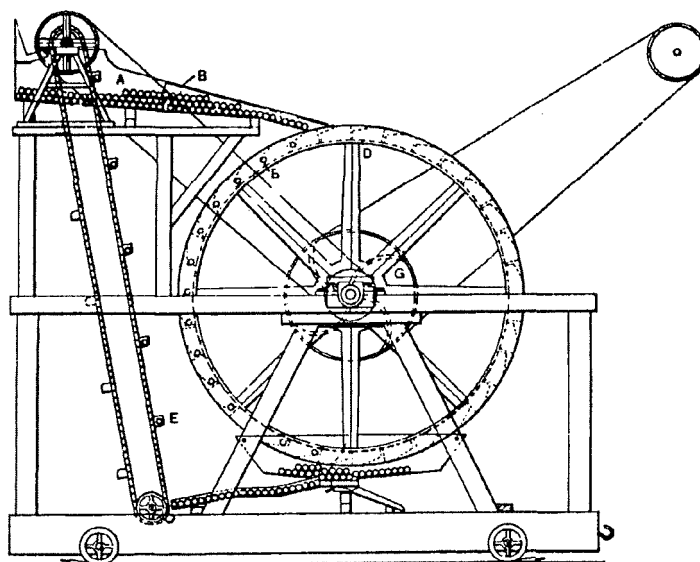

DEFINING PERPETUAL MOTION

## DEFINING PERPETUAL MOTION

by The Pundit Curmudgeon, E.D. O'Brian

In the Oxford definition the key phrase is "...motion which goes on forever..." The use of the word "machine" in the Oxford dictionary in effect confirms the reference to "Mech." and "mechanism" in the Random House definition, but leaves one in doubt as to whether or not this confirmation applies to all perpetual motion or only to a species of it which is mechanical in nature. In other words — is there perpetual motion in other than a classical mechanical context? If there is what constitutes mechanics? Can a complex chemical compound be a machine?

If there is a way to resolve this doubt as to the scope of the expression "perpetual motion" it commences with the abbreviation "spec." Chasing down the meaning of the latter leads to pure confusion clearly establishing that English is not an extremely precise language. In the context of the quotation "Spec." can be taken as indicating that perpetual motion is a term which is only applicable to classic mechanical "machines"; it can also be considered to imply that machines are only a single species of a series of species falling under the generic concept of "perpetual motion".

It would appear that the weight of authority is with the latter. If so it is apparent that at least the editors of the Oxford dictionary believed there must be at least several species of perpetual motion devices which after being started will keep operating until worn out or stopped by some force. It is significant that this Oxford definition does not preclude perpetual motion from being the result of the continuous application of some external force or energy. The Random House dictionary takes a somewhat different position in holding that an operating perpetual motion device will continue to operate "...Without any external energy being applied to it."

This last limitation seems to be have been a carry over from the Dark Ages when there was no knowledge of the subtle energies which define and apparently keep the "real" world as we know it functioning. Absolutely nothing in the "tangible" Earthly world of "established" science and technology can escape being influenced by at least one subtle energy such as gravity, the Earth's magnetic field and so on.

Under the circumstances the Random House definition should at least be modified so as to stretch the word "mechanism" to cover any sort of a dynamic or moving circumstance and to make it clear that the operation of a perpetual motion device is in the presence of the normal ambient subtle energies. Even though the Oxford dictionary definition of "perpetual motion" is worded so as to be capable of being interpreted to items which are not "mechanical" in a classical sense and so as to permit an item demonstrating "perpetual motion" to be at least influenced by the normal subtle energies of the world it should be reworded so as to clearly bring it into line with current knowledge.

From these comments it will be apparent that a new

definition of "perpetual motion" is needed. Although many different possible definitions will bring the meaning of the term into line with current knowledge it is thought that the following definition possesses the desired degree of specific indefiniteness and breath to make a good "working" delineation of the expression "perpetual motion": "That action characteristic of anything of a dynamic character which is sustained by one or more normally ambient forms of energy for a prolonged period of indefinite length until terminated by *additional energy or by deterioration.*" Many will be upset at such a modernized definition.

It inherently cuts out the standardized liturgy with reference to the Laws of Thermodynamics that are used to make perpetual motion a technical pariah. Without this gospel limited thinkers will find it impossible to make the seekers of operative forms of perpetual motion look and sound like stupid fools. And maybe with the shackles of an outdated definition established technology many fearful individuals will feel sufficiently secure against criticism to the extent that they can really investigate the applications of subtle energy to a wide variety of behavior caused by the action of one or more subtle forces of ambient and non ambient character.

Of course there will be those who will be fortified with non evidentiary faith and belief to the extent that they argue that any such investigation is spawned in stupidity because any fool knows that friction will preclude the achievement of perpetual motion. No thinking person can rationalize that the functioning of anything in which friction is present will cease in the absence of force or energy overcoming the friction. Such force or energy can be of an ambient character.

The recognition will bring the use of perpetual motion into line with past usage's of the expression. Thus, the characterization of a clock powered by changes in atmospheric pressure as a perpetual motion device of approximately a century ago will be proper under the proposed revised definition of this expression. Similarly the possibility of magnetic motors responding to the earth's magnetic field or perhaps other subtle energies will be an acceptable topic of investigation under a definition such as that suggested.

This will be the case with such devices as well as with other presently socially undesirable items because the subtle energies sustaining their action or operation are of such a character that they in time will cease. Such a view is good old B.S. scented with a whiff of truth. We can expect these energies to continue for a prolonged period of indefinite length approximately corresponding to the length of the term of the Earth's existence. While there is good reason to believe that in an incredibly long period of unknown duration the Sun and all that is associated with it will cease operation at the present time this is not a valid excuse for ignoring the possible effects of those indefinitely continuing subtle energies permeating this Earth.

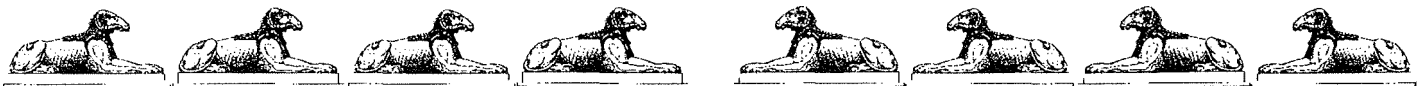

**R**esonant vortex describes the tendency of a fluid to follow a form in motion peculiarly intoned to that fluid at a given density, temperature, and purity. Vortical resonance is also influenced by the volume of fluid involved in the vortex motion.

Vortical resonance is indicated when a vortex exhibits a tendency to sustain over time. Because a vortexian motion has a changing affect on the temperature, density, and purity of the involved fluid environment, it modifies its own resonance. Therefore, the duration of a resonant vortex may vary from an extremely short to longer time as the conditions will tend to vary either toward or away from a currently resonant condition.

Resonant vortex can exhibit harmonic orders of scale in a given fluid medium. Hurricanes, tornados, and dust devils are resonant vortices of earth atmosphere of three differing harmonic orders. Resonance, in these cases, is also affected by the ratio of vortex size to the size of fluid environment. The effective area for a fluid environment is affected by adjacent motions in the fluid.

The visible vortex of a tornado or whirlpool is not the complete form of the motion. A complete vortical motion domain also includes a slower, larger, and expanding motion which completes a circuit of flow from the small higher velocity end of the *funnel form* in the vortex moving outward and around to the more open end of the funnel.

The contracting and accelerating inner funnel shaped component is the portion of a vortex known as the **centripetal** motion. The expanding and slowing outer return circuit of motion is called **centrifugal** motion.

The velocity of a fluid increases as it approaches the axis of the centripetal vortex. As the velocity of a fluid increases, its temperature and pressure decrease. As temperature decreases and via contraction the volume likewise decreases, the volumetric density increases. These combined motional effects may be found in vortices of all orders of scale from sub-micro to super-macro. This can give us glimpse of *MOTION* as the great unifying field. Motional effects are trans-scalar and extend across all densities from sub-material to the unimaginable next step beyond our visual limit.

An individuated and measured volume or unit of fluid can be seen to generally contract while extending its length of arc in the situational environment of a centripetal vortex motion. This general contraction will affect the density of trans-scalar and trans-dimensional space to infinite distances both outwardly and inwardly.

We might say that it is motion itself that creates space. *Space is not curved*. Space is simply space, so high, so wide, and so long. Its motion is what will curve as this is the nature of motion. If motion itself does not create space, at the least, it indicates it. If it hadn't

moved, would it be?

The entire matrix of infinity is entirely involved in the smallest of motions. The smallest motions are affected by the largest motions and vice versa. The highest densities are affected by the lowest and vice versa.

Though a vortex motion may at times, be seemingly complete within itself, all fluid motion is linked by an inductive field of fluid motion. No vortex or flow in any fluid can exist completely exclusive of any and all other motions. In effect, all motions are ultimately part of one infinitely large universal motion encompassing all densities and scales.

## RESONANT VORTEX

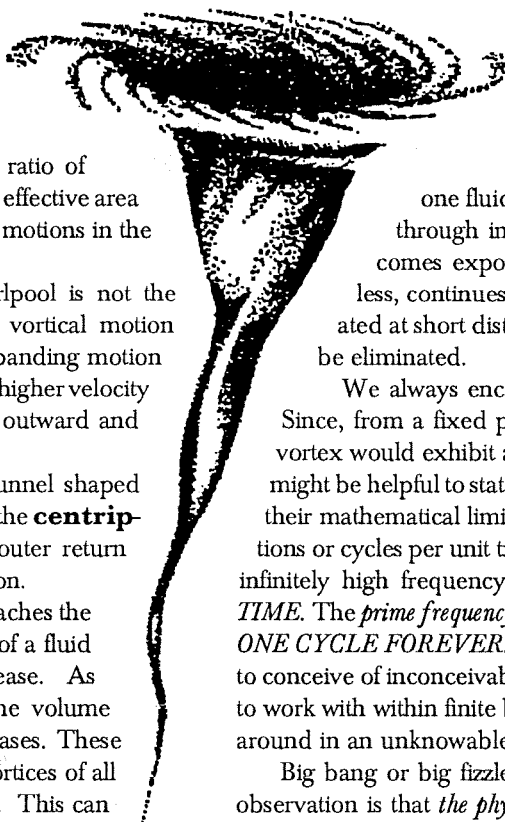

This inductive field of motion is gravity. Because gravity effects, both centrifugal and centripetal, are never unrelated to

motion it is essentially *MOTOGRAVITISM*. Just as wind blowing over the sea induces waves and can heighten and hold up tides,

one fluid's motion affects motions in other fluids through infinite distances. Though the force becomes exponentially small at distance it, none the less, continues to exist. And, though it can be attenuated at short distance by an interfering density, it cannot be eliminated.

We always encounter infinity at the ends of the scale. Since, from a fixed point in space, a moving point within a vortex would exhibit a space relative "waving" relationship, it might be helpful to state the measure of motional frequencies at their mathematical limits, stated in this case in terms of revolutions or cycles per unit time. At the micro end of the scale is the infinitely high frequency or *INFINITE CYCLES PER UNIT TIME*. The *prime frequency* at the macro end of the scale would be *ONE CYCLE FOREVER*. There, with that said we can quit trying to conceive of inconceivable limits and realize that we have plenty to work with within finite bounds. Why should we be *big banging* around in an unknowable Fantasyland.

Big bang or big fizzle, what we can be sure of from simple observation is that *the physical universe is in motion*. If all of the universe that is observable from earth is expanding we can infer only that the region we can see is involved in the generally centrifugal portion of a very large vortex. We can infer from the fact of terrestrial gravity that we are bodily in the centripetal portion of another smaller vortex. What does the word *UNIVERSE* mean? UNUS: one. VERSUS: turning. One turning. Sounds like another representation of our prime frequency.

Motion affects how a unit volume of space fits into the greater space. When a unit volume of space takes up more or less space over a period of time it affects the universe. It could also be stated that this change of density is an effect of the universe. We have in every manifestation of motion, a paradoxical and reciprocal relationship between all that is and what seems to be becoming.

Local changes in direction and density in material and nonmaterial motion fields affect *totality* at infinite distances, at

© 1993 by R. Louis Richards, H.S.D.



different times, and to different degrees via pressure/vacuum waves transmitted through all of the differing fluid densities. Fields that relate, more or less, to the varying densities, to varying degrees, exhibit degrees of permeability and affectability to the other densities, depending on harmonic scalar relationships of motion with each given fluid.

We should note here that all is fluid. Solid matter, as we know it, is only an indication of resonant vortex acting in and on a lesser, nonmaterial density of fluid. What we see as solid matter is fluid motion of sub-micro proportions. Matter is a sensory illusion, created by shear forces, electrostatic charges, magnetic currents, and otherwise lively doings beyond our observable scale.

Somewhat like the propagation of electromagnetic waves, where transmission characteristics change with frequency, the propagation of a motion field is modified by fluid densities. Recognizing that fluids are not required to be material to be substantial, we understand that the medium existing in an evacuated space is very real. Though it is not seen to be material, it retains its character as a substantial fluid. It is known to be an excellent medium for the propagation or presence of various types of fields and radiations. It is nonmaterial but it is not nothing.

Though little is known of the character of the nonmaterial, I will refer to one type of fluid existing in a matterless space as "ether." There may be many levels of density in non-material space, probably decreasing through harmonic scales into infinity. There most likely exists in the etheric realms, as great a diversity of nonmaterial fluids as exists in the material spectrum. For our purposes here, I will identify this generalized ether or *nonmaterial fluid* as the main conducting medium of the inductive motion field of gravity. This fluid is so rarefied as to easily permeate the relatively open spaces of the atom.

Being nonmaterial, the ethers flow through matter, but not without effects. These effects are reciprocal in that ether motion resists and/or induces motion into matter and matter resists and/or induces motion in the ethers. The force of gravity is a drag exerted by relative motion between the material and the etheric substances.

In the case of planetary gravity, a large ether vortex denotes the center that is the locus of the planet. Gravity seems to exert a vertical force but we must remember that our position, relative to the axis, at the equator would be moving along an arc of four thousand miles radius and at approximately one thousand miles

per hour. So, if we drop a rock on the equator, it is already traveling 1,000 M.P.H. along with the fluid of the atmosphere and the nonmaterial fluid permeating that atmosphere.

Both of the flows, the fluid of the air and the ether are serving to continue the rock's thousand mile per hour lateral motion. The air, being at the material level of density has its downward acceleration blocked by the impermeability of the ground which is also at that material level of density. The downward induction of the air is resisted and is realized as atmospheric pressure.

The nonmaterial ether vortex continues its decreasing radius centripetal vortical flow right through the earth's material crust, which drags the material of our dropped rock down until it also encounters the impasse of the ground. The rock is being acted upon by the effects of two fluids. The ether, permeates and drags the rock's material particles laterally and down. The air, while carrying close to the same lateral velocity, resists the rock's fall via its surface drag.

Why doesn't the gravity field strength vary more as we change latitude and approach the axis of earth's rotation?

I believe this is a result of the gravitationally conductive nature of matter. This nature explains the appearance of gravity force being resident in mass. Based on Newton's work, some have made the assumption that mass was the source of gravity force. Mass is only the physical indicator of the gravity in our immediate environment.

The falling apple was Newton's indicator, not a gravity source.

As one would expect under the conventional reasoning, gravity force decreases slightly as one approaches the equator. This is thought to be caused by the centrifugal forces of planetary rotation opposing the (so called) *exclusively attractive* force of gravity. Gravity also varies somewhat predictably, with changes in altitude, the idea here being that the distance from the center of mass is changing. Aside from a few bugging local gravitational anomalies, we come up with a picture that seems to fit in with the *mass equals gravity* scenario.

Something causes the gravity force to be fairly consistent over the entire surface of the earth. Thought to prove the idea of gravity's residence in mass, was an experiment in which two lead weights were suspended in close proximity from a high ceiling by piano wires. The distance between the wires was measured at their upper and lower ends. The measure was less at the lower end. And, the difference amounted to a greater degree than could be accounted for by the radius of the earth. So, it was assumed that this indicated

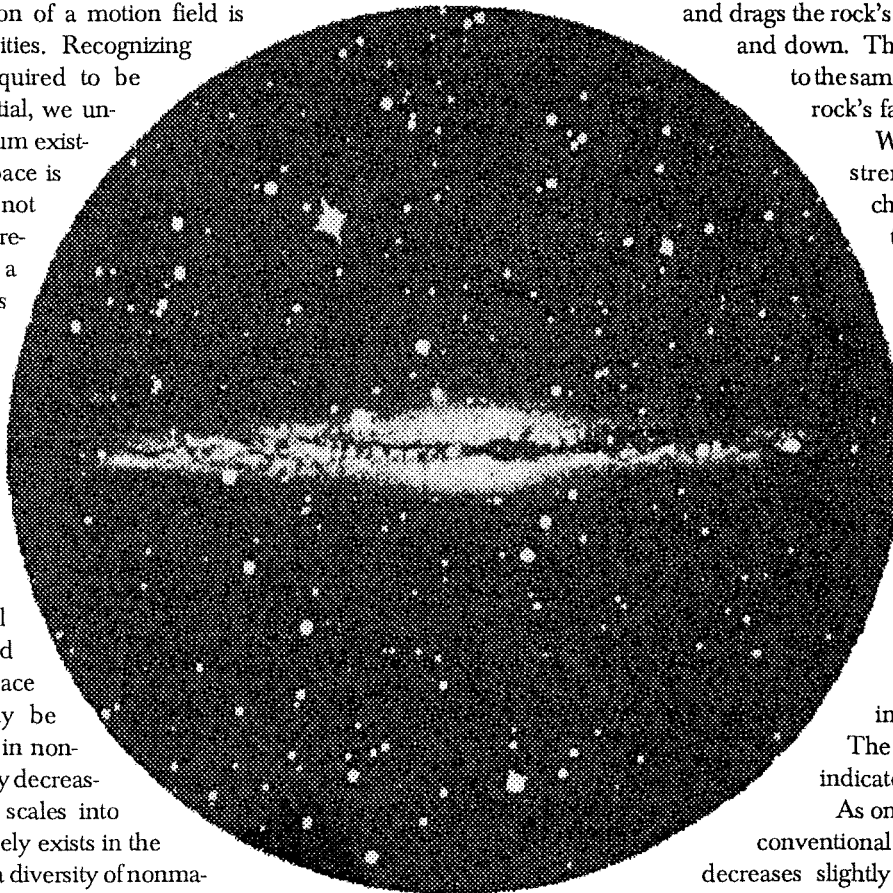

the mass of the lead weights was demonstrating its gravitationally attractive force.

It is, I'd rather believe, that the mass of the lead weights, as an area of high density matter, condenses the ether motion field in accordance with the gravitationally conductive nature of matter. If we were to suspend two *iron* weights and affect the area with a strong *magnetic* field it would appear as if the iron weights were magnets. Just as iron condenses for the so-called magnetic lines of flux, so to, does a mass condense gravitational lines of force. All the lead weights prove to me is that there is in their space an extraneous G-field.

A question arises immediately if we give gravity credit for having another pole. First, what is the physical location of the other or opposite pole? Or, this question could be stated, what is the field configuration of gravity? If, as I have postulated, that gravity is the inductive motion force field of an ether vortex, we must understand the physical structure of this vortex and how its force of motion is deployed?

I fear at this point that we may have to disregard much of our observational evidence to clearly see what is happening. Before we call foul, let me say that we have done most all of this observation in a biased environment, as was the case of the suspended weights. This is the result of our physical point of perspective. We are a tiny point of sense awareness at the bottom of a vast sea of atmospheric fluid, and over, in, and between seas, lakes, ponds, buckets, tubs, and teaspoons of fluid, we have only experienced physical fluids behaving as though existing in layers of flow involved in a vortex of planetary scale. We mostly get to see how fluids already moving in a great vortex act and display their motion.

The inductive forces of our gravity (ether vortex) are making the rules for the fluid in our immediate environment. One reason we have difficulty sustaining a predictable fluid vortex array is because of the relative scale of an encompassing motion field, *earth gravity*. Though we probably will find it **difficult to** impossible to find a field free environment in which to conduct our unbiased observations, a location that is rotating at many hundreds of miles per hour in a vortex that is thousands of miles in diameter is probably not optimum.

So here on earth we can isolate volumes of fluid to try to study them but they will always behave as they really are, part of the laminar flow pattern of a greater vortex's centripetal region.

Motions in fluids here on earth will not conform to laws of flow as they occur in the centrifugal regions of a great vortex, out where the rotational motion is much slower, the fluid less dense, and the expansive motions have repulsive forces.

## ELECTROSTATICS AND GRAVITY WHEN MOTION BECOMES VOLTAGE

In his lifelong study of gravity, Thomas Townsend Brown came to believe that "...there is between electricity and gravity a relationship parallel and/or similar to that which exists between electricity and magnetism. And as the coil is the usable link in the case of electromagnetism, so is the condenser that link in electro-gravitics." T. T. Brown went on to acquire patents on devices using electrostatic fields to produce propulsion and lift. Though there was considerable interest in the development of this research by the military-industrial-security-complex in the 1950s, it quickly disappeared from the campuses in deference to everything from quasars to quanta.

I have come to believe that there exists a relationship between all the forces and *MOTION*. I believe that the kilo/mega volt fields used in the "Bifeld-Brown effect" electrogravitics cause the formation of an ether vortex. Reciprocally, I feel that an ether vortex creates an electrostatic field. In fact, I am convinced that it is in reciprocity we will find a key to understanding all forces, including the *Creative Force* itself. If this be true, the word gravity hardly describes the weighty responsibility that will accompany this understanding.

In electromagnetism it is obvious that a reciprocal relationship exists between magnetism and electrical force. Electrical force can be generated by the "dynamo effect" whereby a current is *induced* in a conductor that *moves* relative to a magnetic field. So too, an electric current passed through a conductor produces a magnetic field. But what of other forms of electrical generation? In piezoelectric effect, when a crystal is distorted, a voltage is produced. So too, when a voltage is applied to a crystal, the crystal distorts. In a chemical-electrical battery like the one in your car, a chemical reaction changes the composition of compounds and produces the voltage. The recharging of the battery by applying a voltage to it, reverses the chemical reaction and restores the compounds to their original composition. There are yet more of these reciprocal relationships in the various means of generating electricity.

When we allow a fluid to be accelerated by a gravity field, and

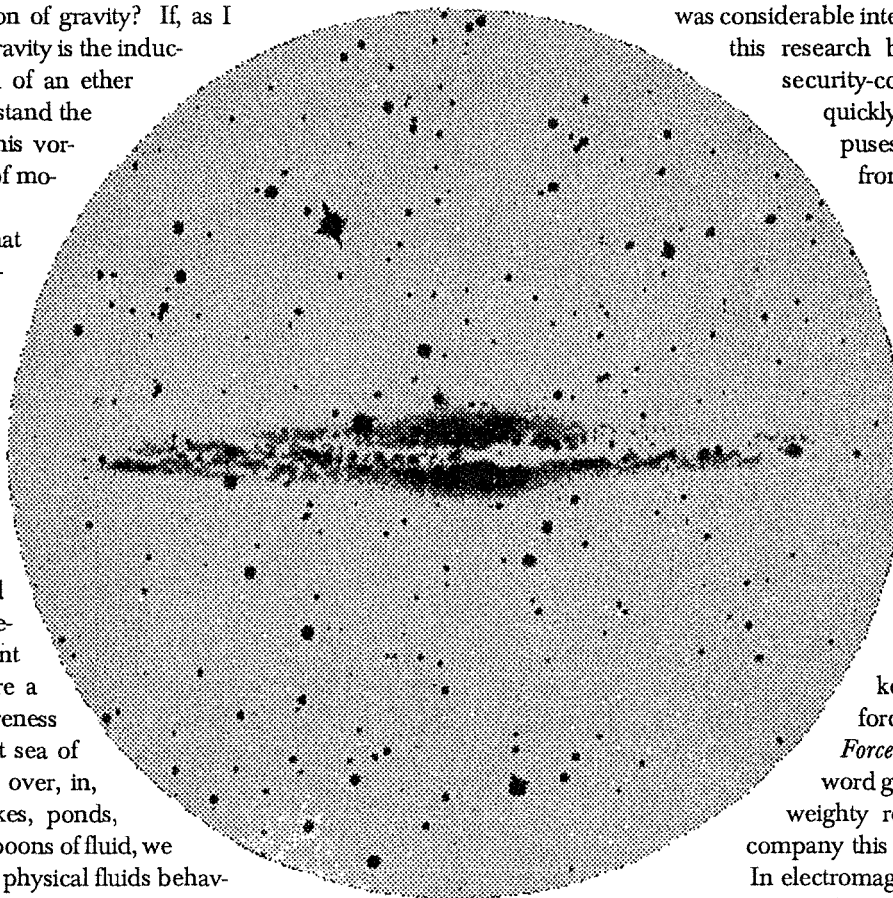

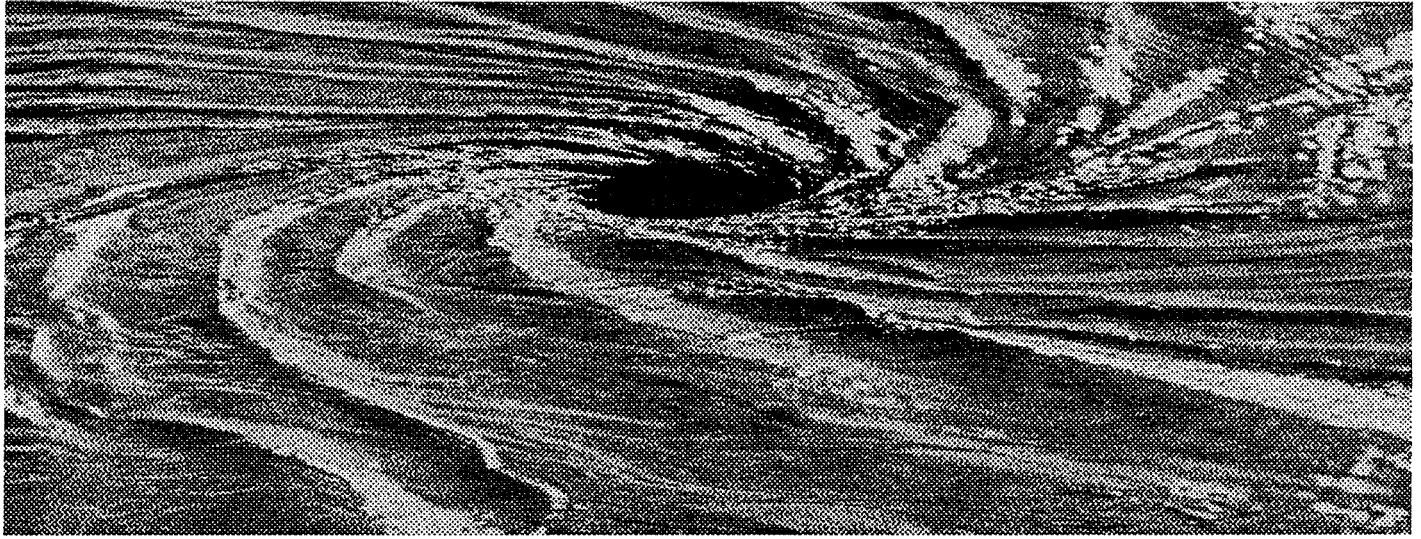

this we can do several easy ways, we can make observations as to the effects. First, let us pull the plug from a tank filled with water. The water accelerates, pulled or driven down by gravity. Soon a funnel shaped whirlpool forms. Why, when all the water has to do is go straight toward the force of gravity, does it careen around and around at high speeds at near right angles to the direction it is ultimately impelled to go?

Now let us stand below our tank which we have elevated above us. We will attach a short, straight cylindrical pipe to the drain outlet. Now we will observe the flow after the plug is pulled. Once again the water is accelerated by the force of gravity. This time, however, the water is free falling toward the gravity source. We will see that the water does not keep to a cylindrical or even a conical form. What we find is that the flow's horizontal cross section distorts toward a teardrop shape which, should we follow the column up or down will twist around in the form of a centripetal vortex. Eventually, the column will fragment as the flow stretches out and surface tension divides the water into droplets. If we were to photograph these droplets and enlarge the image, we would see that the droplets are whirling around a vertical axis. In all of these observations we find that fluid that has been accelerated by the force of gravity has followed the form of a centripetal vortex. Experiments have been conducted showing that a high voltage electrostatic charge forms in and/or around a such stream of water.

So, here we have connections between the centripetal vortex and both gravity and electricity. If the principal of reciprocity applies we should be able to, by creating a centripetal vortex in a fluid, create both gravity and electric fields. Apply a gravity field to fluid, get a vortex. Apply a vortex to a fluid, get gravity. Apply a vortex to a fluid, get electricity. Apply electricity to a fluid, get a vortex.

Motion is a field. It appears here as gravity, there as electricity. When gravity works, there is motion. When electricity works, there is magnetism. When motion and magnetism work together, there is electricity. When magnetism and electricity work together, there is motive force and radiant fields that spread at light speed.

Matter is not necessary for motion to exist. Motion exists prior to matter. Motion exists in and of itself. Motion does not need manifestation so much as manifestation needs motion.

### HOW DOES A VORTEX FORM A SPHERE?

Mechanisms that need to be understood are the motional/structural forces that form the spherical structures in nature. What are the mechanics involved in the formation of the planets, stars, and spherical moons, the celestial spheres? Terrestrial spheres, bubbles and geodes are material structures approaching a spherical shape here on earth. In the animal and vegetable realms, we can find spheroids, too many to mention. In bubbles, a liquid's surface tension, structures a liquid to entrap a body of gas. In natural spherical structures composed of solids we find geodes, meaning "earthlike". Some geodes are hollow, such as "thunder eggs," and some are solid, as are concretions, where a sphere forms in sandstone or shale around a nucleus, usually a bit of calcium like a fossil shell or bone.

In the case of the concretion, it would seem that a chemical-electrical process occurred in the ancient wet sand that buried the fragment of calcium. The spherical form is probably based on the penetration of an electrolytically based field effect from the chemically reacting calcium.

The structural mechanisms of the thunder egg are probably based in thermal and chemical-electrical processes. The interior arrays of crystals could indicate the possibility that an electromechanical effect is also involved.

An ovate rock can be formed in the current of a stream or river where a rock is deposited in a bowl shaped depression, usually in the bedrock underlying the stream, and circulates around, wearing down and eventually attaining an egg shape. Here, there is an obvious relationship between the rock's shape and fluid vortex motion.

In the formation of a liquid bubble there is a physical interaction of liquid and gas in which a body of liquid is pressed out of shape by a gas in an opposing motion. The surface tension of the liquid causes it to keep a unitary integrity and some gas is trapped and the bubble is formed. The surface tension of the liquid might be an electrical molecular bond formed in response to a difference of potential at the interface between the two fluids. Isolated within a calm body of gas, the bubble will approach a spherical form because the gas pressure inside the bubble is equal in all directions and the pressure outside the bubble is likewise

equal, except for the very slight altitudinal atmospheric pressure gradient.

As for the animally and vegetably generated spheres, I guess we'll know about them when we understand all about the *spiral* shaped molecule of deoxyribonucleic acid (DNA) that decides those shapes.

The ovate form of vortex domain is common to centripetal etheric motion environments, such as in this vertically and horizontally biased earth gravity. By vertically and horizontally biased I mean that within the structure of the terrestrial gravity field there are points of equilibrium, perpendicular and parallel to the laminar flow within the ether vortex. This could be viewed as similar the points of equilibrium when a auto goes into a slide on ice. The slide will tend to stabilize out of a spin at 90, 180, 270, or 360 degrees in relation to the direction of the travel.

The spherical domain of vortex must be common to centrifugal regions in "free" space that are relatively unbiased, or equally biased, in the polar axes' two directions. The nature of a complete vortex fluid form within a *centripetal* ether vortex gravitic region tends toward a *funnel in egg* relationship. The centripetal funnel form within, and the centrifugal egg form without, are the components of the complete domain as it exists in a greater centripetal environment. The axial alignment of these domains will be toward points of equilibrium dictated by the surrounding motional structures.

When a vortex domain forms within the matrix of a *centrifugal* region of motion, its nature would be to take a spherical form. The larger expanding centrifugal regions are generally areas of great relative calm. These regions would lack the vigorous polarizing laminar structure, so evident in the contracting centripetal regions. In these regions, electrical forces generated within the centripetal motion core (the more dynamic portion of a complete motion complex) balance their forces omni-directionally, creating an "electric bubble," around the inner void spaces containing strongly positive charged ethers. Within these expansive ether environs, polar axial configurations and relationships are much freer to establish at any alignment in space. This would account for the radical divergence of some planetary axes observable within our own solar system.

So, there, I've said it. A planet or star is an electrostatic bubble. Our earth is a bit of a crusty bubble, but on balance, it's quite smooth. Cranking up my calculator to see how smooth a sphere the planet earth is, I calculated the relative surface relief for a standard globe of twelve inches. If we have a smooth one foot orb and we paint on a layer of 825 one hundred thousandths, slightly more than eight thousandths of an inch, we can then carve all the topography from sea level to Everest's summit from our layer of paint. Our eleven foot tidal variation here on the Lower Columbia River would measure about three millionths of an inch on the scale of our globe. If we shrink our globe farther, down to a one inch ball bearing, Mt. Everest would rise from the sea by less than seven ten thousandths of an inch over a lateral distance of five thirty seconds of an inch from the Bay of Bengal.

Again, on the twelve inch scale model, our crust is a whopping 75 thousandths of an inch, .075", less than *five sixty fourths*. It is interesting to consider an orb of one foot with slightly more than one sixteenth of an inch of brittle stone shell. This shell is fractured, folded, bent, and cracked by faults and plate boundaries. Mountain ranges and ocean trenches are the folds and fractures. Volcanos are vents. Sea floor spreading ridges and plains are new material stretch marks. What could account for its overall roundness and smoothness? The answer must be with the mechanics of the formation of a fluid vortex in a centrifugal region.

The motion field is the unifying field of the known forces. The earth's gravity shows that on the earth's surface we are somewhere near the inner contracting turns of a fluid vortex which is inducing into us our relatively downward acceleration. We are each at a point in this vortex, travelling around the planetary axis at speeds approaching one thousand miles per hour and are not hurled into space! It should be obvious that we reside in the part of the motional curve in the ether vortex called centripetal.

Out beyond the inner whorls, out among the centrifugal motions where the outward moving expansive forces of etheric fluids exist, there we will find the aspect of gravity that prevents the collapse of the solar systems, the galaxies, and the universe. That is where the repulsive force of gravity proves it is not a mono-polar force.







# LEVITATION QIGONG

Dr. G. K. Knowlton

First off, I hope you enjoyed the first article on Qigong which appeared in the last issue. Be sure to save all the issues as the Qigong exercises will follow a step by step pattern and you need to practice each Qigong given per issue. Good enough reason (as if you needed one) to keep your subscription current.

This exercise is entitled, "Levitation Qigong." It derives its name from several sources. One ancient text gives this as an exercise, that with concerted practice, will enable one to physically levitate the body.

Another text states that this Qigong will enable one to do mind projection or astral travel.

I cannot validate the two theories given above, but I know that this meditation will give you faith and courage. In addition, since one's thoughts are not bound by gravity, this will enable you to set goals and plan your life.

I use this Qigong before I go to bed at night and upon arising in the morning. It can also be done whenever tired as the 5-10 minutes you spend doing it are equal to a 1-2 hour nap.

Start off by lying on the floor or the bed. This meditation may also be done seated, but the more relaxed the better.

Hold your hands down by your sides with the thumbs and forefingers touching and making an "O". The rest of your hand stays open. For future reference, this hand position is the "Buddha Palm".

Next perform the following breath percentages: 50%, 90%, 1%, 100%, 30%, 20% with a full breath in between. This controls the amount of oxygen that reaches your brain and puts the brain into a certain receptive state. All Qigongs that I will teach you have breath percentages so always perform them.

In other words, take a deep breath and let 50% out.

From there take a deep breath and let it ALL out. Take a deep breath and let 90% out, then from that point take a deep breath and let it all out. Take a deep breath and let 1% out, then from that point take a deep breath and let it all out. Continue this Pattern until you are finished.

Be sure that you are practicing abdominal breathing and your tongue is at the roof of your mouth as described in my first article.

After you have performed the percentage breaths, simply relax for a few minutes. When you feel relaxed, then you may try whatever experiments you desire such as physical levitation, astral travel or goal setting.

I have never tried the first two, but this Qigong works wonders for goal setting and giving the problems of life over to the subconscious mind, Universal Intelligence, God or whatever force of nature you believe.

Just focus on your problems and see them as having a solution. If you wish a new car, new job, more money, just focus on them briefly and see them coming into completion. Then just release them and continue to relax for another five minutes.

When you desire to end this meditation, simply take three deep breaths before you open your eyes.

Don't worry about the exactness of your percentage breaths, just do what feels right for you.

Practice and enjoy this Qigong until the next issue!

## ABOUT THE AUTHOR

Dr. G. K. Knowlton is a practicing Acupuncturist and Chiropractor at 5555 E. 71st, Suite 6100, Tulsa, Oklahoma, 74136. He has recently been inducted into the World Martial Arts Hall of Fame and the World Sports Medicine Hall of Fame. He has produced the "Physician's Course in Qigong" as an instructional method for developing inner force and applying it therapeutically. Dr. Knowlton may be contacted regarding course availability and questions concerning these exercises and articles.



There has been a magic "cure-all" known by martial artists for centuries. It is called Dit Da Jow and is a collection of herbs that has been soaked in a base of wine, vodka, or plain rubbing alcohol. This liquid could contain from four to one hundred different herbs depending upon the formula.

It is used externally to prevent blood stagnation, promote blood circulation, and reduce pain and swelling from trauma. I have seen Jow so strong that just by applying it, bruises would disappear. It is also used to condition the hand in martial arts training. By applying it to the hands before and after training, the hands are able to deliver a powerful strike, but remain soft and supple.

In my own personal training, I apply the Jow before and after my Gung Fu training which consists of hitting a bag filled with rocks. My hand is now considered an "Iron Palm" (more on that in a later article) and I can break a coconut by slapping it. My hands show no signs of disfigurement. However, if I had tried without using Jow, my hands would be permanently damaged.

My hands actually look no different than before. There are no broken knuckles, or ridges of callus. But if the hand could be opened, it could be seen that the fibers and muscles have strengthened and bonded to the bones in a stronger manner. Without the Jow, no amount of training could have achieved Iron Palm.

I also use Dit Da Jow in my office for pain. It is excellent for such things as back pain, sprains, strains, arthritic discomfort, etc. It is a must for all sorts of external injuries.

Before I continue, I must mention that Jow is for external use ONLY. It is also not to be used on a cut or broken skin.

The only other point of interest is the smell. A good Jow will smell like bad celery. However, it works so well, most do not mind.

For those of you who have been practicing the Qigong meditations in Borderlands, a few drops of Jow on the hands before will increase the flow of chi to your hands.

The word Jow indicates "alcoholic drink" in Chinese and Dit Da Jow translates directly as "Iron Hit Alcohol." It is well known for its injury removing properties, but remember, this alcohol is for EXTERNAL USE ONLY!

The origin of Dit Da Jow is unusual. In ancient times in China they made Dit Da Jow to remove bruises, for Gung Fu training and for sparring injuries. The monks searched far and wide in the monasteries to find the herbs for their formula. They observed injured animals, noting how injured monkeys would find certain plants, chew them and then mix them with water and then pad them over the injuries. The monk would then pick these plants and give them Chinese names for identification.

This was done for many years and a system of herbology was born. They found by mixing the herbs the healing properties would be intensified and soaking it in alcohol (instead of water) would break down the active ingredients faster, it would penetrate faster and effect a more rapid recovery from the injury.

As there were many sects all over China, many different (hundreds) of Jow recipes were developed. My own personal favorite comes from a special formula that has been handed from father to son for over 5000 years.

A good Jow might contain the following:

**Dragon's Blood** (Shweh Jie) Used to remove blood stasis to relieve pain and promote injury healing.

**Red Peony Root** (Ch'ih Shou) Used to remove stagnated blood and according to Chinese medicinal theory to eliminate evil heat from blood. Also for pain and acute inflammation.

**Clove Tree** (Ding Xiang) Promotes circulation and is excellent for local anaesthetic. (Remember "Marathon Man?")

**Chinese Angelica Root** (Dang Gwei) Is said to nourish the blood and invigorate blood circulation.

The above are only a few of the herbs which can be used in a Jow. There are many more, such as Pseudoginseng and Myrrh, and they are mixed in various ratios depending on the particular recipe.

In my opinion there are no high quality commercially made Jows, as they use lower quality ingredients and are not aged. The most effective Jow is that brewed by yourself.

This is done by soaking the herbs in 1.75 liters of vodka, rice wine or rubbing alcohol. (For those of you who are concerned, about cost, I have always used rubbing alcohol with excellent results.) The mixture is then capped and placed in a dark room for at least 30 days. I then take out a few ounces and leave the rest to age. The longer it sits, the stronger it will be.

A good Jow, properly aged for a year can rub out a bruise almost immediately.

Have fun with the making and use of your jow. It is one more tool Borderlanders can use for health. You will soon see why some Chinese refer to Dit Da Jow as "Liquid Gold."

Dr. Knowlton will supply the ingredients for a potent Dit Da Jow for \$50 including postage. If properly used it will make over a gallon, and should last several years.



# FIX KORNER

I  
N  
V  
I  
S  
I  
B  
L  
E  
K  
O  
R  
N  
E  
R  
!  
?  
!  
?  
!!

## UNMASKING THE INVISIBLE

Peter A. Lindemann

If mail here at Borderland is any indication, it seems that people continue to be interested in more information about radionics. My past articles about oranur and the SE-5 have seemingly gone into wide circulation, with copies of copies appearing all over. I've gotten calls from people who have never heard of Borderland wanting to talk to me about clearing oranur. This has been totally amazing. Now, something equally amazing has developed and I thought I should share it immediately rather than wait 14 years, like I did before I spoke out about oranur.

Many people have looked to radionic analysis as a flawless method to discover the true condition of their health, only to be disappointed when the practical reality didn't live up to that high expectation. Most radionic practitioners have had experience with persistent conditions that simply defied analysis. As a practitioner in the 1970's, I went through a number of such disillusionments. It was my utter inability to help certain critical cases that convinced me to abandon public work and focus more on research.

Philosophically we have all believed that the radionic process yields "true" information. This is not exactly the case. I now believe the radionic process only yields "real" information and that reality includes certain conditions that do not register during a standard radionic analysis, even though they are present. My experiences with oranur were my first initiation into this hazy realm at the borderlands of perception. In confronting this situation, I had to overcome my belief that radionics was going to reduce the complexities of reality to a single dimension which I had complete access to. To state the problem clearly, there are a variety of conditions, which for reasons unknown, remain radionically "masked." During a radionic analysis, a masked condition generates a "false negative" indication. This means that if you attempt to discover the presence of a particular

toxic agent, such as copper, all normal analysis methods indicate that copper either is not present or is not acting as a toxin. While this may not be "true", it may be the real picture of a masked condition. For most of us involved with radionic analysis, this has been an insurmountable barrier.

Over the years, a number of researchers have learned to unmask these invisible conditions using a very simple agent. My own understanding evolved slowly along these lines. When using a microscope to view a specimen on a slide, early researchers discovered that "staining" the slide with various dyes made different microscopic organisms easier to see. Royal Raymond Rife perfected this technique by "staining" his slides, not with dyes, but with colored light. His universal microscope was not only the most powerful microscope of its day, it also was the first to use non-invasive color staining techniques to reveal otherwise invisible conditions. With the use of a prism, Rife could "stain" his field of view with any color from red to violet simply by turning a knob on his microscope. The technique proved invaluable to his research. He found that many unrevealing "white light" studies would reveal heretofore unknown agents when stained in a particular shade of color.

When I first read about Rife's work, I was impressed with his genius, but I had no idea at the time that his discovery would have broader ramifications. The next time I heard about color being used to unmask hidden conditions was when I was working with a Vegatest practitioner in Santa Barbara, California in 1990. One of her colleagues in southern California had developed a set of 12 vials that contained simple, nontoxic food coloring solutions based on the 12 colors of Dinshah Ghadiali's Spectro-Chrome system. These vials were used as "filters" to unmask false negative indications during analysis. At this time, I was very familiar with using color as a primary therapeutic agent, but had never imagined using color as an adjunct to subtle energy analysis. When this information came to me, I thought it was interesting, but I still did not understand its full significance.

Only last year, when I was working with Dr. Skye Weintraub, a brilliant naturopathic physician in Eugene, Oregon, did the picture start coming into focus. In a discussion with her about heavy metal toxicities, she told me that when she suspected these conditions, she would order a hair analysis done on the patient. Using chelation therapy and following the recommendations of the testing lab, the various toxins could be eliminated slowly over time. Then she said, that especially in the case of copper toxicity, the first few hair analyses may not show copper as a major toxin, but that after detoxing many of the other agents, copper would show up as a major toxin on the third or fourth hair analysis. In all of these cases, of which she had seen a few, copper was the major and primary problem, but that it had been masked. She told me that the picture of copper toxicity was typically a person who was allergic to a wide variety of agents and foods, combined with an extreme intolerance to most remedial agents.

Then, a divine conspiracy of events transpired to bring my understanding to completion. A lady named Leann started

calling me concerning the oranur clearing process for the SE-5. As it turned out, she had become involved with the SE-5 in an attempt to heal herself of a long-standing and extremely uncomfortable condition. She was allergic to a host of things, including most of the foods she was eating. She was in constant pain. She had been working with her SE-5 for years, but had not been able to get to the bottom of the problem. Her doctor, an allergy specialist, had, likewise, been unable to help. I told her that it sounded like she had a copper toxicity, having just learned of it from Dr. Weintraub. She checked with her SE-5 and found nothing. In a subsequent conversation I suggested to her that she may have a "masked" copper toxicity. I asked her to look again, this time using various "color filters." When she finally typed in "copper toxicity, violet filter" on her SE-5, a very strong positive indication replaced the former negative readings. When she looked up copper metal in the Homeopathic Materia Medica, she found the exact list of her long-standing symptoms. She started treating herself with homeopathic copper (Cuprum Met.) and is, for the first time in years, making steady improvement. Another friend of hers, who had similar symptoms, independently found that violet light unmasked her copper toxicity as well. She is also on the road to recovery. These two have gone on to find certain masked cancers and other metal toxicities to be responsible for other situations that formerly defied analysis in their friends and pets.

To best put this masking process and the use of color for unmasking into perspective, I have drawn this conclusion. A standard radionic analysis is now what I call a "white light" analysis. Like looking into the microscope, not everything is visible in white light, even though it is there. Sometimes we need to "color" our field of view to reveal the particular piece of information that we lack. This is certainly true under the microscope and now seems equally true in radionic analysis.

For SE-5 users, simply type in the name of the color along with the suspected "masked" agent to provide a deeper analysis. For radionic practitioners with other types of equipment, vials of food coloring or rates for the various colors also work well as filters for unmasking hidden conditions. In the future, possibly a rate can be developed that embodies the full rainbow of colors that could be used as a single filter that would unmask any and all conditions that would normally be unmasked by an individual color. This could be a generalized unmasking filter. With this technique, any analysis could be done with and without this filter and if a color masked agent was present, it would show up. This shortcut, generalized filter does not exist for use under the microscope and may not work in radionics either. Only real world testing will prove it out.

We now know that clearing oranur unmask a wide variety of conditions. We also know that color can be used to roll back the vale of invisibility for another whole host of conditions and agents. By using these two techniques, the radionic practitioner can finally look deeper into those cases that have defied analysis and possibly "see" what was invisible before.

# HARMFUL EARTH RADIATION

What dowsers have been maintaining for ages, namely that earth radiation is harmful to health, has now been confirmed in an expensive and exhaustive study by Austrian scientists. Under the direction of Dr Otto Bergsmann (Internal Medicine), a professor at the University of Vienna, doctors, chemists, physicists and biologists of the state sponsored "Working Party for Research into Pathogenic Sites" carried out tests involving some 985 test persons over a period of two years.

A typical test involved dowsers first of all finding a "pathogenic", i.e. health threatening site. The test person then had to sit there for ten minutes. Afterwards the test person was subjected to a very thorough medical examination. This consisted of a number of tests, including blood sedimentation tests, measurements of electric conductance at certain muscle points, of blood pressure, heart beat, breathing, skin resistance and blood circulation. In order to eliminate any "placebo effects"— the body's response to the mere belief in such effects — the tests were organized in a "double-blind" fashion: neither the examining doctor nor the test persons knew whether and when they were in a disturbed or neutral place. The enormous number of 462,421 measurements were taken in a total of 6,943 individual tests. Although the test persons were exposed to the disturbed zones for only a few minutes, harmful effects could be registered in many cases. "One can easily imagine the dire consequences which exposure to these disturbance zones over many years could have" was the comment of the periodical **Natural Medicine**.

Translation of an article  
published in the German magazine  
**ESOTERA**, Feb 2, 1991,  Facts, page 7.

# STRANGE PHENOMENA AT URITORCO HILL

by Jorge Resines

Located in the square enclosed by parallels 31°S and 32°S, and meridians 64°W and 65°W, at the Argentine province of Cordoba, Uritorco hill has been the center of strange events over the past four to five years (depending on the source of information employed).

Designated as "Cerro Uritorco" on the map of Image No. 1, pictured above, this hill is located at the intersection of a meridian and a parallel in the grid discovered by Bruce L. Cathie and also of a meridian and a parallel in the grid whose pole I located at 59°30'W and 39°56'35.77"S (see my book *The Energy Grid (III): Mathematical Transformations and the Many-Grids Theory*", a BSRF publication). Therefore, being the "crossroads" for two different types of energy grid, it collects a lot of power and — as it will be seen in the coming lines — I would not discard the idea of there being an underground Titan city beneath it. If so, as the late Richard Shaver indicated in his writings, the whole of this immense city would be contaminated by negative etheric flows and that is a place to be avoided.

Despite the many different happenings (which will be accurately summarized by the articles translated in this writing) none of the many amateur investigative groups who went

to the place have been able to give a verifiable explanation of whatever went/ goes on at the place.

It is sad for me to state that of all those groups investigating UFO phenomena (that can be classed in two sorts: (a) the "scientists" who accumulate reports of sightings and do nothing with them; and (b) the "Spiritualists" who expect the coming of "Space Brothers" to deliver them from the evils of this planet) none have a working knowledge of the energy grid and what it means.

Now, in order to accurately acquaint my fellow Borderlanders with the events, I decided to translate two articles from different Argentine newspapers, to wit:

1. From the newspaper "Clarín" (Bugle), May 27th, 1991:

## Uritorco Hill for sale, US\$100,000

by Ricardo Acebal

Surpassing the offer made two years ago by provincial authorities, US\$50,000, the owners of Uritorco hill, at Capilla del Monte (province of Cordoba), again offer it for sale but at US\$100,000. They offer its 1954 meters in height and 1000 hectares around (about 4074 acres); and as to tempt possible buyers the inheritors to Mr Gaston Fontaine Silva — such was the owner's name — state that "this is one of the few terrestrial hills that release energy, not in vain was it visited a short time ago by many people interested in alien contacts".

Heading the demand, the main interest in buying these lands is a local businessman who plans to place atop Uritorco

hill an aerocar and a fast-food restaurant. However, the greatest resistance to this and other offers was shown a few days ago by the people from Capilla del Monte city, who think that "the hill should be under the rule of Argentine National Parks (a government agency) or a foundation guaranteeing the care of plants and animals", Mr Monir Adur, one of the neighbours, told us.

The wish of the locals aims to provincialize Uritorco hill, but the government of

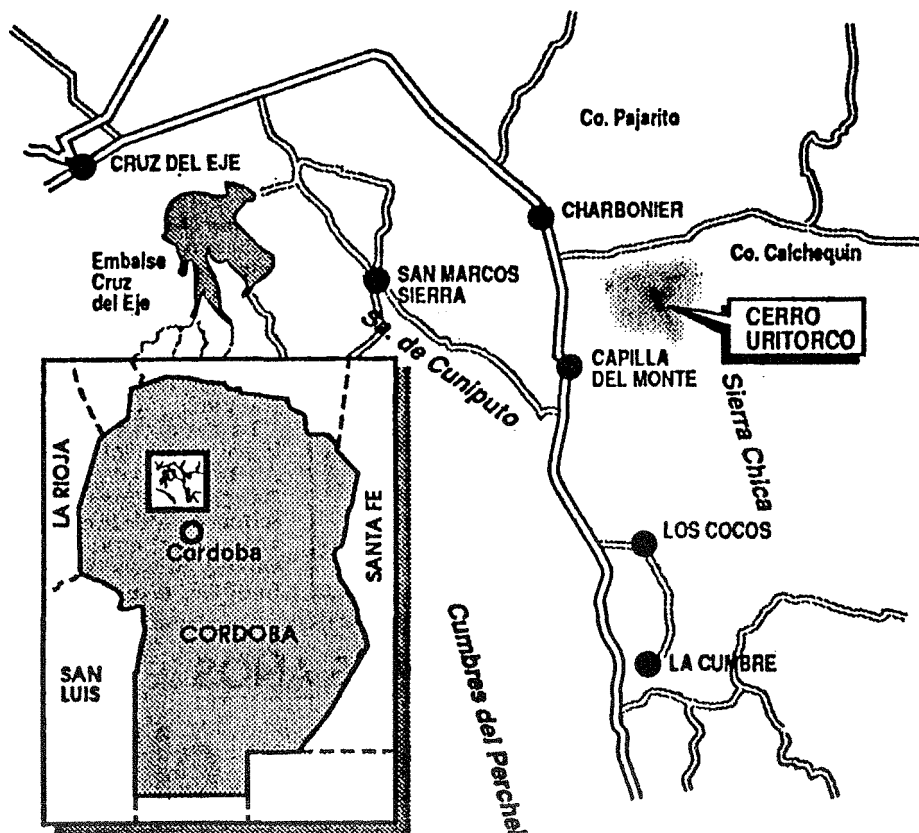

Cordoba province is yet to answer the 1989 offer of \$50,000, and so far has not sent a representative to the heirs of Mr Fontaine Silva. A couple of decades ago the hill was chosen by members of several communes, former hippies, linked to famous gurus from India. Since those times, the almost 2000 meters of the hill have been named places "full of good energy".

Even if the citizens from Capilla del Monte city admit to be "a little tired of so much esoterism, not always made with responsibility and seriousness", most of them confessed to have sighted luminous "UFO-shaped" objects several times, according to statements sworn before police authorities of Cordoba province. Neighbours of the place do not always tell of the rare events they see around Uritorco hill, "because we do not want the hill to become the sleeping quarters for seekers of objects from other galaxies", stated Mr Monir Adur. This gentleman remained silent a little then indicated: "Well, we also do not want it to become a noisy city. Let it be a hill".

### **The Magic of the Flashes:**

"That of the energy could be true", says the neighbour Mr Monir Adur, "for this is an uraniferous place. There is a rare phenomenon I call 'piezoelectricity'. It happens that with the heat during the night, when in the zone of the Los Alazanes dam, I saw flash-type illuminations happen. So, suddenly, in a microsecond everything is illuminated. And one wonders 'Have I seen it or not?'. Everything becomes blue and you do not see even a cloud. Perhaps what I state may not sound true, but this is an often recurring phenomenon at Uritorco hill. That's why this hill is a meeting-place, a holy hill for Capilla del Monte. There, in old times, the tribes (of local indians) gathered together for a calendaric ritual during which was established the day of the year Chieftains and Shamans would meet".

As if to certify his statement, Mr Adur accompanies his tale with a book on history from the province of Cordoba: "It is not verified, but here it states a 'triangle of forces' with vortexes in Sierras Gemelas, the Vero hill and the Uritorco hill. It also

speaks about the city of Erks".

Because of this book, and other tales, since 15 years ago Capilla del Monte began to be "invaded" periodically by groups of scientists who studied and photographed the zone.

### **"Citizens of Erks":**

Many years ago the Greek citizen Mr Angel Acoglanis lived for a long time at Los Terrones (a place with rocky formations in the zone of Uritorco hill). He stated that on certain nights there shone what he called "the city of Erks". During a period of months he led a group of explorers to witness the strange phenomena.

The tale was that Mr Acoglanis sent messages to the "citizens of Erks" in a language very similar to Peruvian Quechua (Note: That is, one of the languages spoken by Peruvian Indians. The other, main language, is called Aymara). "From there, they answer. Look...!" stated Mr Acoglanis. And in the sky, say the locals around Uritorco hill, there were luminous signals.

True or not, the case is that under the name of 'Erks' at Capilla del Monte they now speak of an "energy manifestation that surely created precedents". One day, Mr Acoglanis decided to give up that place, got married, had six children and lived at Buenos Aires city. He purchased a department at Callao Avenue, where one night he was murdered. A citizen of Capilla del Monte says that "the Greek knew he was going to be killed for he had a very important message to tell, which finally he took to his grave. It was related, I think, with taking advantage of what happens at Los Terrones".

Most people at Capilla del Monte know about what happened to Mr Acoglanis, and whenever he is named somebody is grateful that "he never got a dime for taking many believers with him (to be in) the moment of the event". Among those taken to the place was the UFO-investigator Mr Fabio Zerpa.

(END OF FIRST ARTICLE)

2. From the Newspaper "Pagina/12, el pais a diario" (Page No.12, the country daily), June 1st, 1991:

## **State-managed UFOs**

(unsigned)

To avoid the first contact with extraterrestrial beings as the privilege of a few, the people of Capilla del Monte (province of Cordoba) will become the owners of the celebrated Uritorco hill, favorite of UFOs at their time of parading. The matter's settlement is the result of an agreement between the community of Capilla del Monte and the Ministry of Agriculture of Cordoba province who wanted to sell the hill for US\$100,000, and of course it was not because of the ETs. (END OF THE SECOND ARTICLE)

I suppose that, in the mind of many a reader, when poring over the statements by Mr Monir Adur on "flashes of blue light", the thought "orgone!" must have also flashed. And I think that here it is proper to decode the name 'Erks' by using the Mantong Alphabet given to us by the late Richard Shaver:

**E = Energy**

**R = Ray**

**K = Kinetic**

**S = Sun**

So, in short, the name for that alleged city would be "Irradiating Source of Energy with a Non-localised Character", as opposed to an irradiating source whose action is only of a local character. The letter "K" is what makes the difference.

So, if the city exists and the sudden blue flashes are an indication of it, is it possible to tap it as an energy-source?

If (and this should be an "IF" indicating a great reservation) the place is not contaminated, unlike what Richard Shaver indicated for most Titan-built underground cities, then great care should be taken in the implementation of the tapping-devices. Remember that two different grids, one related to the Earth's magnetic field (Bruce Cathie's) and another related to lightspeed in grid-terms (yours truly's), interact at the spot. And anything made by the locals will have to take this fact into consideration.

Whatever they do, and whatever happens at Uritorco hill's zone, you will know as soon as I can verify the information and write to this publication.



# THE CLASSICAL ETHER CONCEPT AS A POTENTIAL MODERN THEORETIC UNIFYING PRINCIPLE

by Michael Baran

*Abstract: The failure of current theories to unify gravity with the other known forces suggests the possibility of a theoretic defect or gap at some basic level. In the present article, the author proposes reconsideration of the ether - theory, discarded nearly a century ago, and uses the ether - concept to construct a theoretic model of gravity, magnetism, and the elemental forces of cosmogenesis.*

The concept of a universal ether is an old one. A super-fine medium associated with the stars and with the light of day, known as the ether, was universally recognized in ancient times (1,2). In more recent times, all the leading classical physicists from Isaac Newton to James C. Maxwell considered such a medium to be a necessary condition for the action of forces through space. The idea of an ether was discarded in the first quarter of the 20th century, when physics adopted a view of the universe based on the measurable particle mechanics and time-space relativity of the photon/electron quantum particle. However, that overview has not yet led to a unification of gravity with the other known forces, nor can it

account for the "absence" of 90% of the matter that ought to be apparent in the universe. This writer believes that it would be appropriate to reconsider the ether-theory, and would postulate the existence of a world of not-yet-defined "etherons," hypothetical units far smaller than quantum units, but, presumptively, analogous to and possessing most if not all the structural and energetic capabilities as known particles.

The classic experiments in physics to detect ether drift effects were mostly done around the turn of the century. Most of them, including the well known Michelson-Morley experiment, obtained results interpreted as indicating that an ether does not exist. These results predisposed the physics community to abandoning the ether concept, a movement that became official when the relativity concept became popular. However, there continued to be a number of prominent dissenters to the abandonment of the ether theory, including A. Michelson (3). Dayton Miller, a colleague of Morley at the turn of the century, continued their experiments into the 1930s, and always maintained that they indicated the presence of an ether, because no matter what modifica-

tions or new conditions were introduced into their basic protocol, a null effect was never found, and the ether drift effect found, although less than predicted for a *uniform* ether, was, most importantly, systematic (4,5). It is interesting to note, with respect to the other reported experiments, that of those that obtained negative results, all (including the original Michelson-Morley experiment) used earth-related parameters, whereas of those that were positive, all used outer-space-related parameters. Moreover, the ether drift effects observed in the positive experiments always seemed to descend from space (6). All these observations would be expected with the ether model of gravity to be described below, which would indicate that an ether would display more of a "presence" in space than near a planet like the earth, and that this is the mechanism of gravity. It also indicates that the earth's magnetic field is much stronger, and much more ethereal, than is currently believed; the field would be much stronger still, well inside the planet.

The ether concept lends itself to a model of gravity as an ether drift effect arising from magnetic processes taking place predominantly at the etheric level, associated with cosmic bodies. With this model, the earth's magnetic field would be viewed as arising from not-yet-defined linear processes that begin at the level of the etheron. The model of etheric magnetism, to be outlined below, would imply that the ambient etherons in the vicinity of a body like the earth are constantly undergoing consumption by magnetically-mediated aggregative processes, into larger particles, such as electrons. Thus, the ether near the planet would be thinned out relative to the ether in space. Since the ether in space would comprise a much larger number of much smaller particles, with a greater net surface area, than the ether near the planet, the ether in space would press toward the planet, exerting the force of gravity. The "curvature of space" would represent a differential-resonative effect on photons caused by the non-uniformity of the ether, there being more magnetically-energized etherons near bodies than in outer space, which would affect the paths of photons and of light-mediated observations of space.

This model of gravity would largely hinge on the corollary question of the origin and nature of magnetic forces in an ether. Probably the most basic way to consider this question would be by theoretically-modeling the elemental magnetic forces of cosmogenesis as they would arise in an ether. (A Big-Bang-scale model of cosmogenesis would be difficult to construct with an ether theory alone, but it does lend itself to a small-scale model, as follows.)

If it is assumed that cosmogenesis in an

ether would be the result of a disturbance of a quiet, unenergized, zone of etherons, organized magnetization would proceed in three stages: polarization, resonance, and organization. Initially there would occur a setting-in-motion of the etherons. As etherons encounter other etherons, most of the encounters would be tangential brushes, which would set the etherons spinning and impart magnetic polarity to them, as well as affect their direction of movement. The initial chaos would immediately give way to more stable magnetized field-forces, as follows. Spinning, polarized, singlets of etherons would resonate with certain other singlets. (One way to conceptualize the scenario would be to imagine spinning metal balls moving under water. It is easy to see how two balls having the same spin-direction would be attracted or repelled differently by the wave effect than a pair with opposite spins.) Random ambient etheron singlets would serve as a wave-bed for resonating pairs and larger groupings. Larger groupings of etherons which, by chance, have a similar direction of motion in the ether would, as they cross other similarly-aligned analogous groupings, undergo a linear process that would accelerate magnetization at this level of organization. (The crossover-effect would tend to align the spins of particles within their own fields, magnetizing the fields.) In this way, gradually building, increasingly-organized, magnetic systems would arise in the ether. The favored types of systems would be spherical and rotating, like atoms and stars, because only in a rotating system in which centrifugal forces balance centripetal forces will the system neither implode nor dissipate.

A required assumption in a cosmogenesis model like this is that the density of the elemental particles is unimaginably-intense, allowing the rise of vast, organized, magnetic systems. With such a model, as just seen, an ether theory rationally leads to a model that not only unifies gravity and magnetism, but also the elemental forces of cosmogenesis.

It might also be noted that it leads as well to a rationale for a mysterious theme, psychism. The same concept as outlined above, of a magnetic etheric continuum of the material with the ambient, provides a model incorporating the possibility of ethereal magnetic phenomena of the psychic type; of ethereally-tuned magnetic interactions involving the more-etheric components of atomically-structured physical systems, such as humans.

Invoking the paranormal mode still further, this writer's background as a researcher of esoteric archival sources has led him to an interesting linguistic hypothesis concerning the concept, developed early in this article, of an intensely-magnetically-energized planetary interior. Is the actual derivation of the word "nether" from "na'ether"? "Na" (as in the Hindu "prana" and the Pacific island term "mana") is a well known ancient/esoteric term for "energy".

Yet another paranormally-related hypothesis based on the ether concept might be mentioned. Space probes (7) have revealed an amazing degree of vulcanism and geological instability on Venus. Its violence recalls to the mind Immanuel Velikovsky's theory (from his book "Worlds in Collision" 1952) that Venus was once a comet that closely brushed the earth, within the time span of modern man. One hypothesis that could account for Venus' surprising surface turmoil would be that it resulted from gravitational forces during such a fly-by. Curiously, the earth and Venus are almost exactly equal in size and mass. Therefore, it could be further hypothesized that the two bodies might have resonated in such a way due to wave-effects in the ether.

#### Bibliography

1. Homer: *The Iliad* XV.20.
2. Ibid., XVI.365.
3. See, T.J.: *Astronomische Nachrichten* No. 5044, May 1920, p. 4.
4. Miller, Dayton C.: *Rev. Mod. Physics* 5, 203 (1933).
5. Miller: *Phys. Rev.*; Jan. 14, 1934, p. 114.
6. Lodge, Oliver: *The Ether of Space*. BSRF, Garberville, Calif, 1991
7. *Science News* Sept. 7, 1991, p. 149.

## Virtual State Bureau & Archives

Murphy's Law Computer Information Network is now the Virtual State Bureau & Archives. VSBA is one of the fastest growing and most comprehensive alternative information resources in the U.S.A. Our online file section contains the highest quality exploratory science articles and information available, highlighting the union between creativity, science, and life. Our message areas include thought provoking and informative alternative science issues, providing a forum for experimenters and artists alike.

VSBA also provides over 13,000 files and programs covering topics from literature to astronomy; from computer programming to artificial intelligence. Subscription is \$30US a year, and allows you the following access:

- 70 minutes on line a day
- Up to 10 times on per day
- 30 Megabytes of download credit
- No Upload requirements
- Access to all file areas.

#### FEATURING:

### REGULAR SOLAR & LUNAR, ATMOSPHERIC, & GEOPHYSICAL INFO FOR RESEARCH PROJECTS

with online solar terrestrial indices, worldwide earthquake info, satellite weather photos and maps for the U.S.A. and Europe.

Other topics include: Alternative Energy, "Free"

Energy, Earth Energies, Experimental Radio, Radionics, Experimental Music, Cabalistic and Metaphysical Sciences, Ætheric Science, Dowsing, Orgone, Tesla, Hollow Earth, Canopy Theories and Geological Anomalies, Ætheric Art, and more.

With your subscription, you will also receive our quarterly newsletter. In it you will find the latest news on all frontiers of knowledge, featuring articles direct from the network, information and research in the fields of alternative science and art, and the most recent updates concerning Virtual State Bureau & Archives.

## Virtual State Bureau & Archives

P. O. Box 2253

Redway, CA 95560

Voice (707) 923-4186

Modem (707) 923-4897

Shannon Murphy ♦ Michael Theroux

# TREMENDOUS NEW POWER

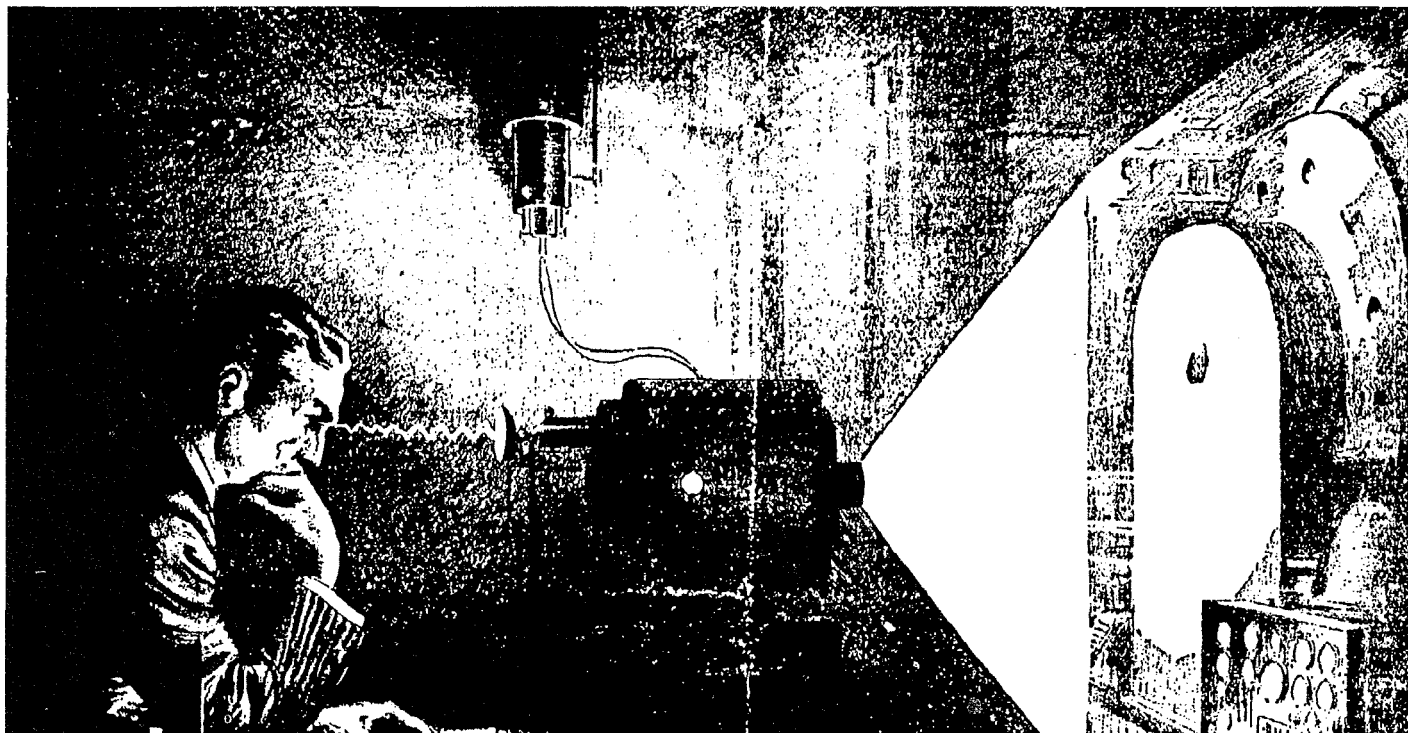

## SOON TO BE UNLEASHED

by Carol Bird, **Kansas City Journal Post**, Sunday, September 10, 1933

**P**ROVING his theory that a man's efficiency and accomplishments should increase and not diminish with mellow age, Nikola Tesla, inventor, physicist and one of the world's leading electrical technicians, enters his seventy-eighth year busily engaged on three or four great scientific projects.

Several of these inventions or discoveries will be looked upon as "miracles" by many people, for Mr. Tesla has long been a scientist years ahead of his time, one whose advanced theories have alternately stamped him a "madman" and a wizard.

Just as people ridiculed Copernicus' theory of the planetary system, the unlightened jeered Tesla's pronouncement, years ago, regarding cosmic rays. The pathfinder and the pioneer—and Mr. Tesla is both—are always condemned by the masses.

NIKOLA TESLA, tall, lean, with the face of an ascetic and deep-set eyes, whose expression denotes concentration on a canvas of work too big for most people's comprehension, partially described a new and inexhaustible source of power he has discovered after years of research, revolutionizing modern physical science. At the same time he touched on his own reservoir of energy which makes such monumental discoveries possible at his advanced age.

How does he tap both these deep wells? What is the secret of fine health, keen mind, unusual vitality and mental force at 77, the time of life when most men are sitting in the sun with shawls over their knees or, alas! lying beneath the sod?

Mr. Tesla is the father of the alternating system of power transmission and

radio, the induction motor and Tesla coil.

Asked about his startling new scientific discoveries, one of which concerns the "photographing of thought," which will, he maintains, bring about a tremendous social revolution, he said:

"My first and most important discovery concerns the harnessing of a new source of power, hitherto unavailable, to be developed through fundamentally novel machines of my invention.

"I am not yet prepared to dwell on the details of the project, for they must be checked before my findings can be formally announced. I have worked on the development of the underlying principles for many years. From the practical point of view of the engineer engaged in power development, the first investment will be relatively very great, but once a machine

# Nikola Tesla, Starting His 78th Year, Works on Revolutionary Power Project and Also Is Completing Process for Photographing Thought



is installed it may be depended on to function indefinitely, and the cost of operation will be next to nothing.

"My power generator will be of the simplest kind—just a big mass of steel, copper and aluminum, comprising a stationary and rotating part, peculiarly assembled. I am planning to develop electricity and transmit it to a distance by my alternating system now universally established. The direct current system could also be employed if the heretofore insuperable difficulties of insulating the transmission lines can be overcome.

"Such a source of power obtainable everywhere will solve many problems with which the human race is confronted. My alternating system has been the means of harnessing 30,000,000 horsepower of waterpower, and there are projects now going on all over the world which will eventually double that amount. But, unfortunately, there is not enough waterpower to satisfy present needs, and everywhere inventors and engineers are endeavoring to unlock some additional store of energy."

WILL the smashing of the atom lead to this new power energy? Let Mr. Tesla answer:

"The public is naturally led to expect a great revolution through the harnessing

of atomic power, but this is an illusion. Atomic energy is not available for work. I operated many years ago apparatus of a capacity of 2,000 horsepower and tension of 18,000,000 volts with which trillions of atoms were smashed in a fraction of a second. I generated all sorts of intense and destructive rays, but found no trace of any energy which should have been liberated through the shattering of atomic structures, according to theory. For the last thirty years I have warned my fellow scientists that there is nothing to be expected in this field except some specific effects due to changes in the atomic structure which may have more or less value."

Beyond adding that the new form of energy which he has been investigating many years would be available at any place in the world in unlimited quantities, and that the machinery for harnessing it would last more than 5,000 years. Mr. Tesla would say little more on the subject. Just when the power will become available for practical purposes he could not predict with any degree of precision. In a few years, perhaps, he ventured to say.

Mr. Tesla then talked of several other projects on which he has been working by way of relief from too much concen-

tration on the main piece of work. He described one of his other interests, one highly dramatic, which stirs the imagination and which, doubtless, will sound too revolutionary to most people. But it must not be forgotten, as Mr. Tesla points out, that the ideas of television and radio and airplane were scoffed at in their infancy.

"I expect to photograph thoughts," announced Mr. Tesla calmly, in the same tone of voice that a person occupied with some trivial things in the scheme of life might announce that it was going to rain.

Continued Mr. Tesla: "In 1893, while engaged in certain investigations, I became convinced that a definite image formed in thought must, by reflex action, produce a corresponding image on the retina, which might possibly be read by suitable apparatus. This brought me to my system of television, which I announced at that time.

"My idea was to employ an artificial retina receiving the image of the object seen, an 'optic nerve' and another such retina at the place of reproduction. These two retinas were to be constructed somewhat after the fashion of a checker board, with many separate little sections, and the so-called optic nerve was nothing more than a part of the earth.

"An invention of mine enables me to

transmit simultaneously, and without any interference whatsoever, hundreds of thousands of distinct impulses through the ground just as though I had so many separate wires. I did not contemplate using any moving part—a scanning apparatus or a cathodic ray, which is a sort of moving device, the use of which I suggested in one of my lectures of that period.

“Now if it be true that a thought reflects an image on the retina, it is a mere question of illuminating the same properly and taking photographs, and then using the ordinary methods which are available to project the image on a screen.

“If this can be done successfully, then the objects imagined by a person would be clearly reflected on the screen as they are formed, and in this way every thought of the individual could be read. Our minds would then, indeed, be like open books.”

BESIDES his discoveries concerning the harnessing of the new energy, television and thought photography, Mr. Tesla is working to produce a type of radio transmitter which will insure the strictest privacy in wireless communication regardless of the number of subscribers, and he is developing some important discoveries in molecular physics which will revolutionize the science of metallurgy and greatly improve metals.

After a discussion of his new scientific findings, Mr. Tesla turned to the subject of his personal source of energy and what he considers the real values of life.

“One of the most fundamental and also one of the saddest facts in human life is well brought out in a French proverb which, freely translated, means: ‘If youth had the knowledge and age the power of doing.’” said Mr. Tesla. “Our condition of body and mind in old age is merely a certificate of how we have spend our youth. The secret of my own strength and vitality today is that in my youth I led what you might call a virtuous life.

“I have never dissipated. When I was a young man I understood well the significance of that old French proverb, although I doubt that I had even heard it then. But I seemed to have a clear understanding while still young that I must control my passions and appetites if I wanted to make some of my dreams come true.

“So with this in view, quite early in life I set about disciplining myself, planning out a program of living for what I considered the sane and worthwhile life.

“Since I love my work above all things, it is only natural that I should wish to continue it until I die. I want no vacation—no surcease from my labors. If people would select a life work compatible with their temperaments, the sum total of happiness would be immeasurably increased in the world.

“MANY are saddened and depressed by the brevity of life. ‘What is the use of attempting to accomplish anything?’ they say. ‘Life is so short. We may never live to see the completion of the task.’ Well, people could prolong their lives considerably if they would but may the effort. Human beings do so many things that pave the way to an early grave.

“First of all, we eat too much, but this we have heard said often before. And we eat the wrong kinds of foods and drink the wrong kind of liquids. Most of the harm is done by overeating and underexercising, which bring about toxic conditions in the body and make it impossible for the system to throw off the accumulated poisons.

“My regime for the good life and my diet? Well, for one thing, I drink plenty of milk and water. Why overburden the bodies that serve us? I eat but two meals a day, and I avoid all acid-producing foods. Almost everybody eat too many peas and beans and other foods containing uric acid and other poisons. I partake liberally of fresh vegetables, fish or meat sparingly, and rarely. Fish is reputed as fine brain food, but has a very strong acid

reaction, as it contains a great deal of phosphorus. Acidity is by far the worst enemy to fight off in old age.

“Potatoes are splendid, and should be eaten at least once a day. They contain valuable mineral salts and are neutralizing.

“I believe in plenty of exercise. I walk eight or ten miles every day, and never take a cab or other conveyances when I have the time to use legpower. I also exercise in my bath daily, for I think this is of great importance. I take a warm bath, followed by a prolonged cold shower.

“Sleep? I scarcely ever sleep. I come of a long-lived family, but it is noted for its poor sleepers. I expect to match the records of my ancestors and live to be at least 100.

“MY SPEEPLSSNESS does not worry me. Sometimes I doze for an hour or so. Occasionally, however, once in a few months, I may sleep for four or five hours. Then I awaken virtually charged with energy, like a battery. Nothing can stop me after such a night. I feel great strength then. There is no doubt about it but that sleep is a restorer, a vitalizer, that it increases energy. But on the other hand, I do not think it is essential to one’s well being, particularly if one is habitually a poor sleeper.

“Today, at 77, as a result of well regulated life, sleeplessness notwithstanding, I have an excellent certificate of health. I never felt better in my life. I am energetic, strong, in full possession of all my mental faculties. In my prime I did not possess the energy I have today. And what is more, in solving my problems I use but a small part of the energy I possess, for I have learned how to conserve it. Because of my experience and knowledge gained through the years, my tasks are much lighter. Contrary to general belief, work comes easier for older people if they are in good health, because they have learned through years of practice how to arrive at a given place by the shortest path.”

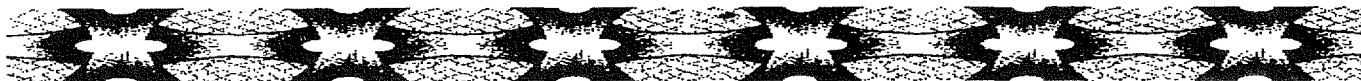



# SCHAUBERGER

*versus*

# ARCHIMEDES

*Conclusion*

by **Albert Zock**

*THE FIRE WITHIN*

**H**erodotus does not report that the Great Pyramid was a rain machine, nor does he write about the Sphinx, probably the pump did not work anymore, and the Sphinx was already buried under sand. However, he gives clues that there was something special about it, as he does not give the Egyptian name, which was for sure not "Pyramid". As a Hellenian, Herodotus used the Grecian language, and probably coined the name himself, as PYRAMID consist of two Grecian words "PYR" and "AMID". "PYR" stands for "fire" and "AMID" means "within" or "in the center of", and as a matter of fact, the firing chamber is nearly in the exact center of the Pyramid.

The Encyclopedia Britannica 9th edition states, "When the Egyptians started a Pyramid, they first cut a level platform in the solid rock. Then they cut shafts down into the solid limestone below the platform. Over these shafts, they added masonry which formed a "sort of cove around" on which the Pyramid was build. Over the subterranean chamber was build a mass of masonry, which was gradually added to at the sides and top, according to the power or wealth or the length of life of the founder. What nonsense, they did what every engineer does before he can start building — he sets up his machines, and in this case, it was a water pump, and such pumps are known today. **Every Man's Encyclopedia**, volume 10 #136-1070, pictures such a pump, known as "The Hydraulic Ram" (see figure 6). A glance at it gives the impression of a failed attempt to draw the inside of the Grand Pyramid, so great is the resemblance! "A" could be the underground diagonal with its air cushion, "B" the Queen's chamber and "C" the Grand Gallery, but the Pyramid-Pump is much more evolved!

The Encyclopedia explains; "The hydraulic ram uses the force of a larger flow of water to raise a small quantity to a higher level. Water from a dam is allowed through valve "A" until the velocity causes the valve to close. This

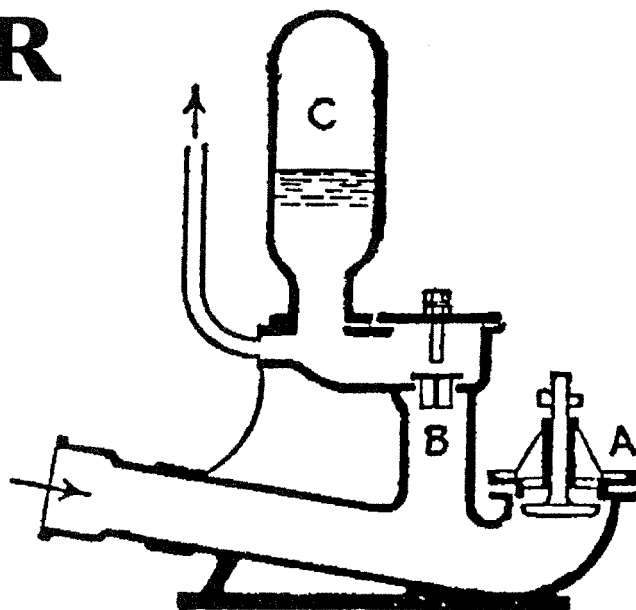

Figure 6 HYDRAULIC RAM PUMP

stops the flow, causing a sudden rise in pressure which forces open valve "B" to the delivery pipe. After this energy is spent, valve "A" opens again by its own weight and the cycle is repeated. An air vessel "C" is fitted above valve "B" to even out the flow and reduce damage to pipes due to water hammer. Note, that "C" is positioned vertically instead of diagonally as in the Pyramid! Is there something the Egyptians knew, but our engineers do not?

Now compare the above with the Pyramid. Water from Lake Moeris is led through the lower diagonal with valve "A" see Figure 7 (the 8 inch round holes of the former hinge are still there, only the wooden planks are missing) into the lower chamber known as "The Well", which in reality served as an air compressor, until the velocity caused the valve "A" to close. This stopped the flow, causing a sudden rise in pressure which pushed the water up through the jet into the lateral connection and into the "Semi Enclosed Bowl" by opening hinged wooden valve "B". After this energy is spent, valve "A" opens again, because the recoil force has been removed. An air vessel "C" (Queen's chamber) is fitted above valve "B" to even out the flow from the upper diagonal, to even out water hammer effects.

The upper diagonal has been reversed to simplify the hydraulic principles. The lower diagonal holds 88 tons of water, while the upper one holds 300 tons. The whole pump when full, contains about 600 tons. The lower compression chamber supplies the upper one, while the upper one discharges its water to the outside.

Another advantage of this ram pump is its size and shape, as liquids and gases flow more freely with less friction through a square tube, than that of any other shape. The lower diagonal is 220 feet long and descends at an angle of

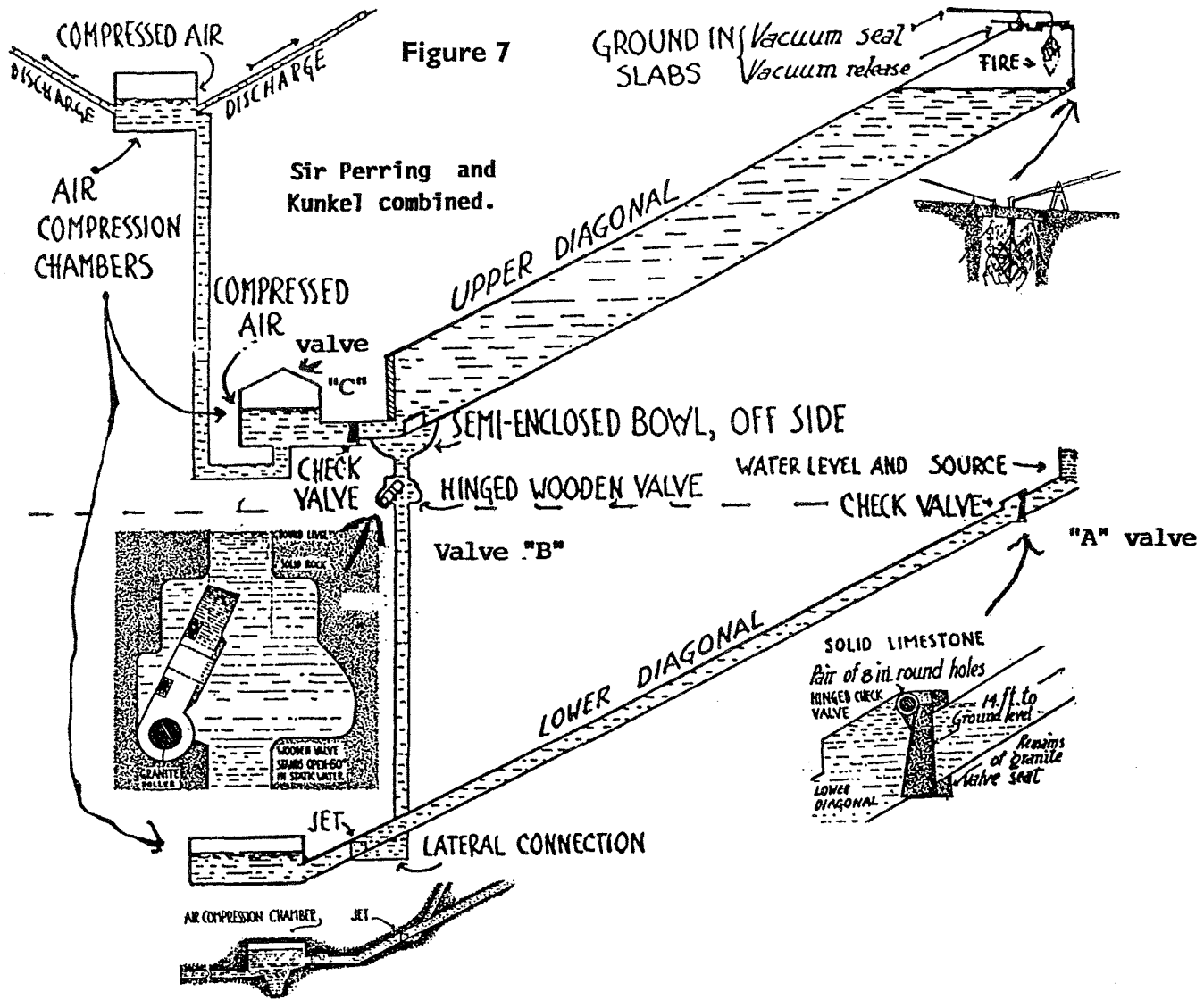

Figure 7

Sir Perring and Kunkel combined.

26 degrees, and ends at a depth of 100 feet. When full, its static pressure alone is about 40 pounds per square inch, how much greater must the pressure be, when it came crushing down.

However, this over 3000 years old ram pump had an additional clever trick, which thanks to Sir Perring's drawing from 1837, has been preserved! The floor in the underground chamber has a saucer-like depression of about 20 feet in diameter, and in the middle of that, is a conical pit, 7 feet across on top, and 9 feet deep. Perring's 100+ year old drawing of this pit, shows a raised, right hand spiral-like formation, descending along the pit's wall, ending in a hump on the bottom. When Kunkel visited the Pyramid, he found that only 4 feet of this formation was left. The angle of the spiral's descent, is about 30° and its surface was smooth like a baby's buttock. The raised hump was gone, as a 3' x 6' hole had been cut in the bottom of the pit.

At first, Kunkel had not much success with his pump, as the only energy he used was his breath. Finally, in 1952,

using Perring's drawing, Kunkel formed a plexiglass model of this chamber on a scale of a 1/2 inch to a foot, including two and a half turns of that right hand spiral along the pit's inner wall, ending in a hump at the bottom.

Now, when Kunkel blew down into the lower diagonal tube, there was a discharge reaction of about a half gallon of water and a part of it even jumped 22 feet away! It took some time before he realized what was going on down there.

When the incoming water enters the underground chamber, it starts to rotate, because of the saucer-like depression in the floor, which in turn, caused a whirl in the pit. This action reduces resistance at the entrance, because the whirling water rotates in the same direction, it increases the velocity which augments the force of gravity, and Kunkel was convinced he had rediscovered a "New Force", a whirlpool in an airtight tank!

What Kunkel did not know was, that he had tapped into one of "The Many Faces Of Implosion", put to work,

probably, in history's first "Air Compression Chamber, early 2000 B.C. model". Here is, where two identical ideas meet. Victor Schauberger experimented with conical fiberglass pipes with a spiral like dent manufactured into them, resulting in a raised spiral on the inside, (Figure 8 is from his Austrian Patent No 196680). The ancient Pyramid builders were more bold and incorporated this Implosion Principle on a large scale into their Ram Pump. If

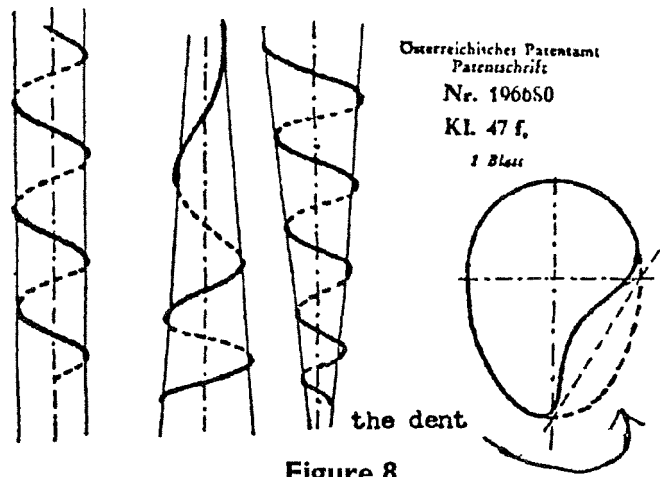

Figure 8

today's engineers could be persuaded to do the same, we could have almost FREE ENERGY! Note on Figure 7 that valve A and B are on the same level as the pavement. If we slowly let water run into the lower diagonal, it would fill the whole pump. But, if we let as much water down as the diagonal can handle, it will not only fill every space, but its weight and velocity will compress the air in the lower chamber against the ceiling to the uppermost degree, and when the flow stops, the compressed air will try to get even and push back, but a minute recoil will press against valve A and close it. Now, the only way to go is upward. The lateral, pressing water far behind buoyant valve B, from where it cannot come back, as just a slight dissipation will close the trap, due to the weight above, which in turn initiates a new cycle in the lower diagonal. The water column in the lateral will remain motionless, because of the vacuum created underneath valve "B".

It can be assumed that with each cycle, most of the water within the chamber will be pressed through and behind valve "B". It took 10 years to build this pump, as Herodotus reports; "It took 10 years for the preparation and 10 years to build the Pyramid". This pump has no moving parts beside the two valves and can work without interruption, supplying water for barges and water-locks on each course up.

Bernoulli discovered that, if an orifice of a tube has clean sharp edges, and the tube is not longer than three times its cross-section, the discharge from such a tube will be increased by more than 25%. While Bernoulli's theorem calls for a tube only three times longer than its diameter, Cheops pump has it nine times longer. This difference of proportion may be explained by the facts, that the Egyptians were working with a 100 foot head

of water with a volume of 85 ton-plus? Add to this, the resistance to flow has been reduced, because the symmetrical is wider than high, it is 220 feet long and descends at an angle of 26 degrees. So perfect is its alignment, that one can sit at the bottom and see the sky, as liquids and gases flow freer through a square tube than of any other shape.

The upper pump is of a complete different nature, it works on a vacuum. To understand the mechanics, make a simple experiment. Glue a candle into an aluminum pie pan, fill with water, light the candle and turn a milk bottle upside down over it (Figure 9). Notice how, as the flame of the candle consumes air, the atmospheric pressure pushes water into the bottle.

Now imagine two identical airtight tanks. On one tank we attach, right at its bottom, a vertical tube like the milk bottle and on the other a diagonal one. Each tank contains the same amount of air, however, the air in the diagonal tube, will hold up twice as much water than the other, just because of its diagonal position. Further, watch the ratio of air to water, as we multiply every dimension by two. First we start with a tube 120 inches long and two inches square, that is  $2 \times 2 = 4$ , times 120 that makes 480 cubic inches of water, and the air that holds it up is two lbs. If we multiply all dimensions by two, that makes the diagonal tube 240 inch long and 4 inch square, which amounts to;  $4 \times 4 = 16$ , times 240 that gives 3,840 cubic inches of water, but only 4 lbs. of air are needed! If we do this three times more, we will see that only 32 lbs. of air are needed to hold 36 tons of water! That means that, as size increases, less energy is required to create movement and the ancient Egyptians

were masters with diagonal tubes, as these work in a compounding way. They used two air tight tanks with diagonals, and placed one unit above the other and connected both with a third tube at the bottom of each tank.

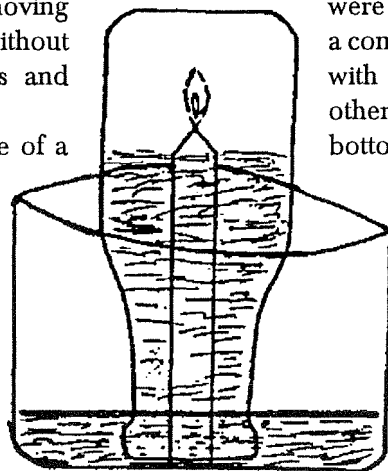
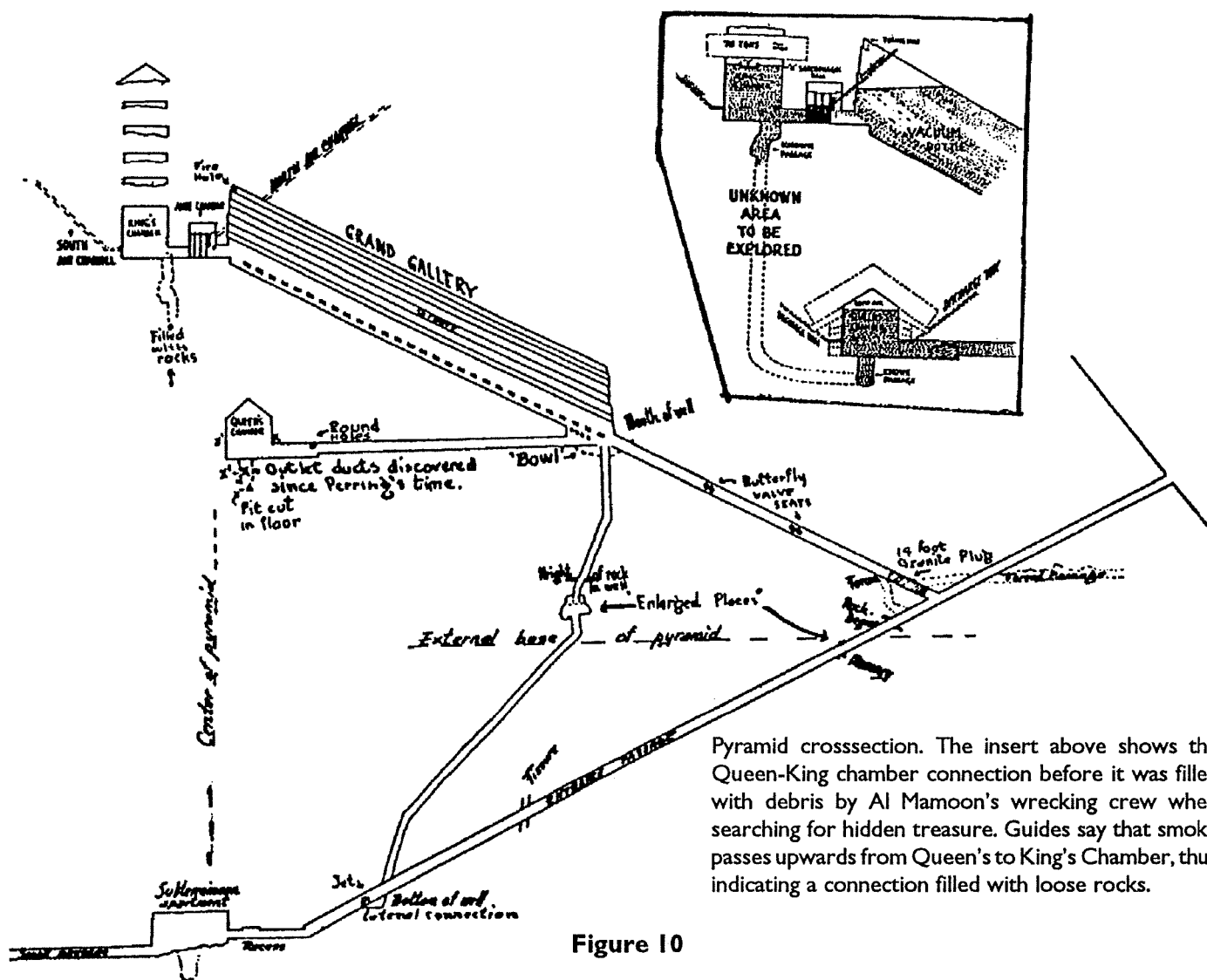

Figure 9

Kunkel called it the Jet-Bowl-Tube, because the lower connection contains a jet, while the upper end forms a bowl-like chamber. The flow in each diagonal is automatically controlled by a hinged check valve, made with railroad ties like wooden planks. In the lower diagonal, the valve is near the entrance and closes vertical, while in the upper one, it is at the bottom, like a trap door, closing flat, but



Pyramid crosssection. The insert above shows the Queen-King chamber connection before it was filled with debris by Al Mamoon's wrecking crew when searching for hidden treasure. Guides say that smoke passes upwards from Queen's to King's Chamber, thus indicating a connection filled with loose rocks.

Figure 10

opens when the underground air compressor pushes water up the Jet-Bowl-Tube. All walls in the Grand Gallery support the assumption, that it served as the main diagonal, because the walls are tilted 5° inward to resist hydraulic pressure, all joints are precision cut and it is impossible to force a needle in anywhere. Slots arranged along its whole length, suggest that airtight movable partitions were used to create a vacuum for drawing up water at any finished part during construction.

When construction was finished, the open end was sealed, but a small opening was left for a vacuum device to suck air out. As soon as air is sucked out, or otherwise eliminated, at the upper end of the diagonal, a vacuum develops and the water starts to lose its density, because the atmospheric pressure is taken from it, and if this continues, it will rise and take off pressure from valve "B". When this happens, the atmospheric pressure outside will force additional water down the lower diagonal into the compression chamber, which in turn will push it further up through valve

"B", to even out the vacuum, and when the upper diagonal is filled, it holds 300 tons of water. As soon as the vacuum is released, the water regains its full density, which is now enormous, and by pushing downward, will close valve "B", diverting the flow through check valve "C" into the upper air tanks, (Queen + King's chamber) compressing their air cushions until they can't take it anymore, the back pressure will close valve "C" and blow the water up and out the tubes marked "discharge," known as air vents. Note, both upper compression chamber, Queen & King and discharge tubes, have no valves, but still accumulate air pressure, because the discharge tubes have only a diameter of eight inches, which guarantees an even and prolonged water distribution over the outside walls!

To illustrate this process accurately, we have to use the real position of the Grand Gallery, (see Figures 10 & 11, as in Figure 7 it was reversed), to simplify the complementary hydraulic principles of one diagonal on top of an other. Figure 10 is a composition of Perring's drawing, as he made

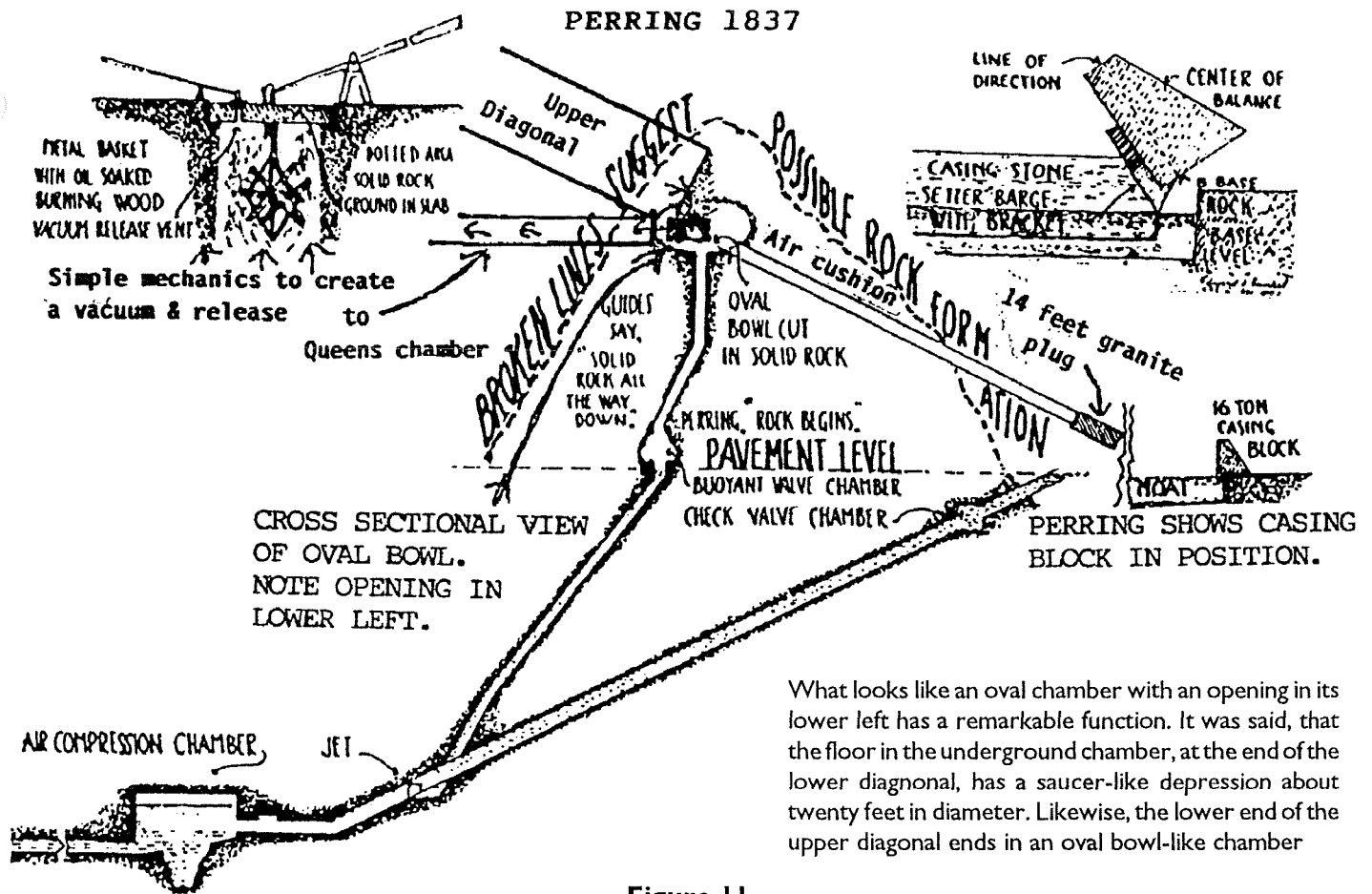

Figure 11

What looks like an oval chamber with an opening in its lower left has a remarkable function. It was said, that the floor in the underground chamber, at the end of the lower diagonal, has a saucer-like depression about twenty feet in diameter. Likewise, the lower end of the upper diagonal ends in an oval bowl-like chamber

several. He does not show the two lower discharge tubes from the Queen's Chamber, nor the eight inch round holes in the long horizontal passage leading to it, but Maspero shows them and so does Encly. Britt. 9th Ed. Further, he did not mentioned the outlets at the bottom of the Queen's Chamber, as these were later discovered.

However, more revealing is Perring's Figure 11 as it shows a casing stone in its position, smack on a moat chiseled out of the solid rock, which archeologists say, had water in it brought up in jars from the river. Napoleon's men in 1799 found two incisions in the rocks that served as sockets for the corner stones, and two more were found in 1865, cut 8 inches into living rock. Finding a socket in each corner, seems to indicate there were 4 water-gates in this canal, mak-

ing it possible to lower the water on one side, leaving the other three undisturbed, proving a good water economy. This drawing also gives a cross sectional view of the oval bowl with connection to the Grand Gallery and Queen's Chamber passage

What looks like an oval chamber with an opening in its lower left, has a remarkable function. It was said, that the floor in the underground chamber, at the end of the lower diagonal, has a saucer-like depression about twenty feet in diameter. Likewise, the lower end of the upper diagonal ends in a oval bowl-like chamber.

The difference between a saucer and a bowl is depth, meaning it can handle more water and it must! Because, when the vacuum is released, 300 tons of it, it starts pushing down, closing valve "B" flat and the only es-

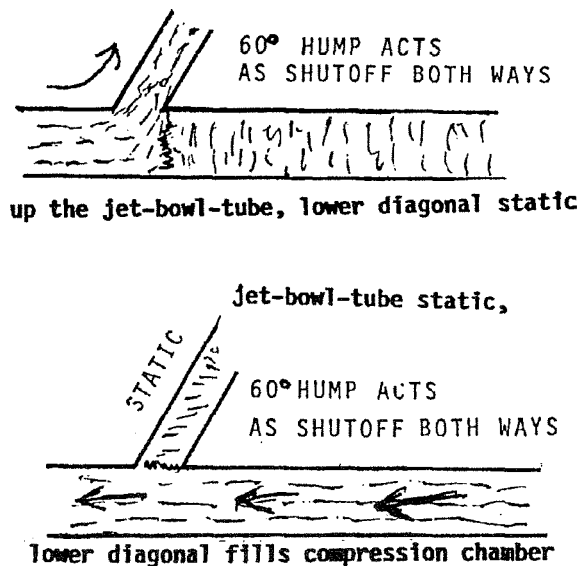

Figure 12



cape left, is the "Queen-chamber-duct" in the left lower corner, forcing it to make a sharp turn, and that is the reason why the bowl is oval. Such bowl will induce a whirl, not only in itself, but also in the upper diagonal, and within the Queen's chamber duct, as the whirl reduces friction to almost nothing. Further, the spinning vortex will draw out gases of combustion, as fresh air will be pushed up with the water from below, setting the smoldering fire ablaze again.

For years Kunkel did not understand, how this bowl, presumed made of masonry, could function without flying apart by all this pressure? He was dumbfounded when

the guides told him, it is cut in solid rock, which is all the way down. The discovery that this bowl was cut in solid rock provided him with a new concept — that the Pyramid's core is mostly solid rock, instead of masonry. This, at least 80 feet high, cathedral-like, rock formation supports all chambers, including the sloping west wall of the upper diagonal, and its land itself as the foundation, in which the ancient engineers cut a groove in which the block ends are embedded with mortar. It follows then that the amount of quarried stone is far less than if it were build from ground up, and not a single author, of history or Pyramid Books has mentioned the existence of this rock formation. Another important fact is the presence of the firing chamber! The ceiling, at the uppermost end of the Grand Gallery, is not only blackened with soot, but it also has an opening into the firing chamber above! Behind this hole is a boxlike, rectangular enclosure, which even Perring reports. Kunkel found ashes and charred bits of wood, mute evidence that at one time fires were burning here. Kunkel was very relieved, it was to prove his theory was right!

The Austrian Herman Waldhauser, who is likewise convinced the Pyramid was a rain machine, went on to search for clues outside the structure. If large stone surfaces served over long periods as water evaporators, in time a layer of efflorescence should accumulate, and to

*Cheap water for everybody—  
New sources of power:—  
Atmospheric pressure compounded  
Gravity compounded.*

*Peak efficiency when 4 is almost full—Then it has a maximum head and a minimum amount of air for removal.*

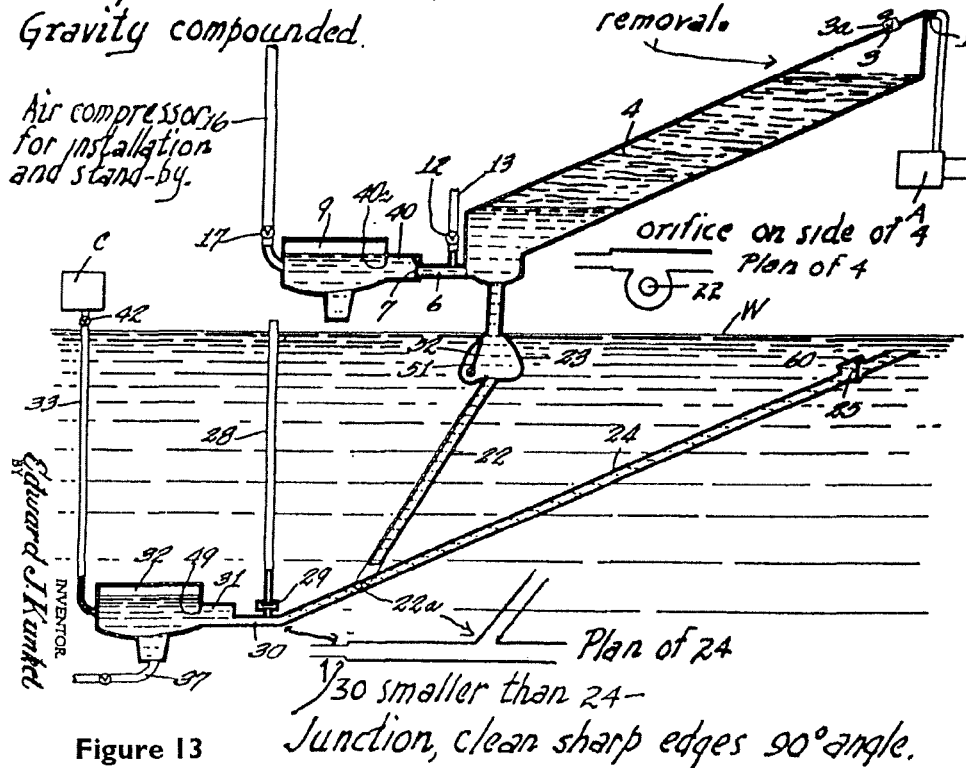

Figure 13

*30 smaller than 24—  
Junction, clean sharp edges 90° angle.*

May 26, 1959

E. J. KUNKEL  
HYDRAULIC RAM PUMP  
Filed Jan. 5, 1955

2,887,956

Waldhauser's relief, it did, including half-pencil-deep water channels.

### PHARAOH'S FLOATING ALARM BELL

The sarcophagus in the King's chamber, all archeologists agree, is too big to pass through the entrance, and all agree it was put there before the walls and ceiling were finished. If the sarcophagus is struck with stone or wood, it will ring like a bell. Kunkel believed it was not meant to float freely in the King's chamber, as the slightest movement of water could cause it to bump against the walls and ring, which would not have any purpose. However, if it were fastened loosely in a wooden frame, made of cedar logs, this would prevent useless bumping, as it would only ring when it hits the ceiling, and would help floating as well. I sense your raised eyebrows, so I must explain. Granite is not as heavy as most folks think, it is only slightly heavier than aluminum. One cubic foot weighs 170 lb., compared to aluminum which is only 5 lb. lighter, 165 lb. In addition, if it is submerged in water it weighs only 107 lb.; because of that heavy slabs of granite can be easily moved when covered with water, the more the better! The bumping of it against the ceiling signaled that the King's chamber was almost full, or the air cushion dangerously low. About four feet from the floor in the King's chamber two shafts with a diameter of

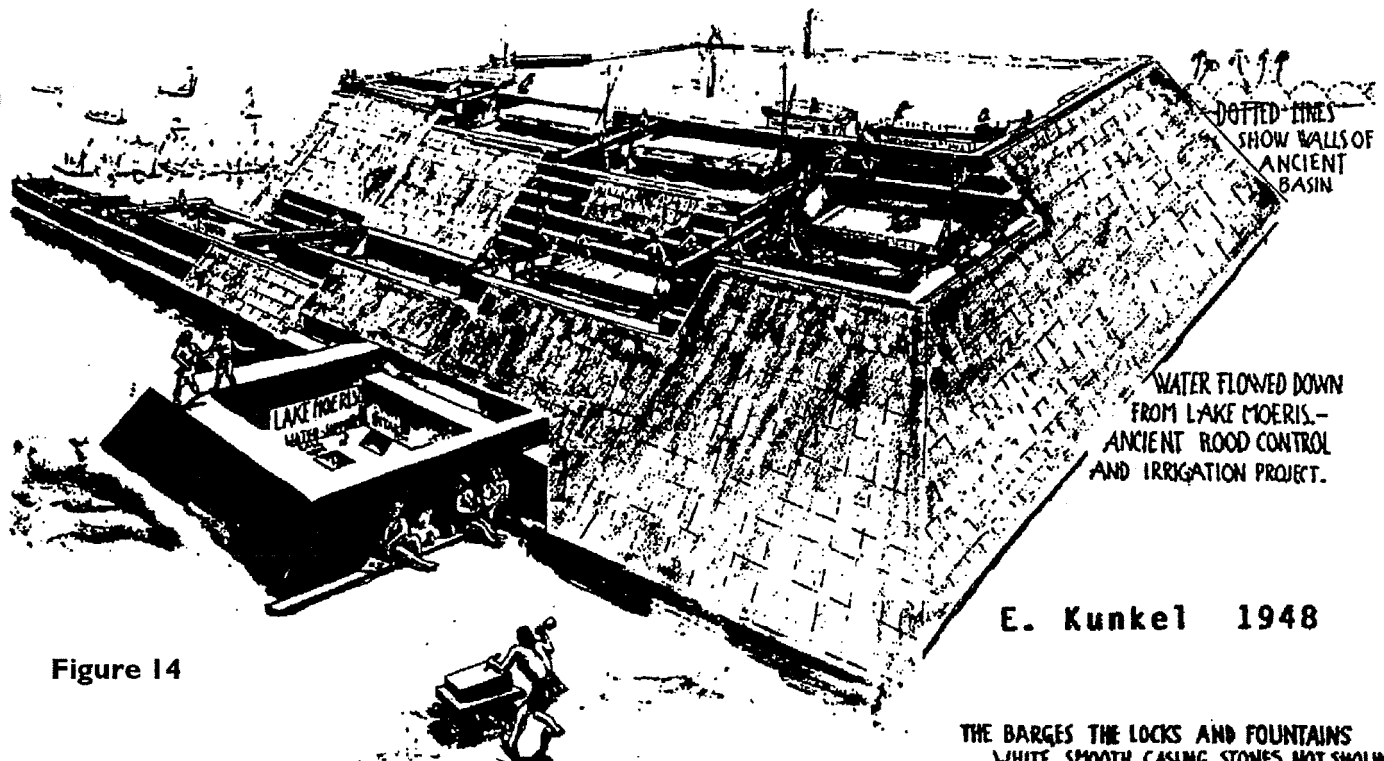

Figure 14

Zig-zagging up across the northern face can be traced an ancient "carriage road." Along its route are holes 8" round. This road was afterwards filled in with small stones. No evidence showed that it was used as such. A system of locks seemed more logical.

THE BARGES THE LOCKS AND FOUNTAINS  
WHITE SMOOTH CASING STONES NOT SHOWN!

WATER FLOWED DOWN  
FROM LAKE MOERIS.—  
ANCIENT ROOD CONTROL  
AND IRRIGATION PROJECT.

E. Kunkel 1948

eight inches, lead to the outside, about 275 feet above the pavement, they are known as air vents, but for Kunkel and others, they are the discharge-tubes.

### WATER—FIRE—AIR

Now, as we know (almost) how each part works, let's go for a trial spin. A fire of oil-soaked wood in an iron basket has been lit, lowered and sealed in the highest part of the upper diagonal in a way that vacuum can be interrupted when needed. As vacuum forms, water is sucked up in the jet-bowl-tube, which triggers a strong push from the compressed air in the underground air-chamber. Owing to a cleverly designed spiral-hump, quite unique in hydraulic engineering, carved in living rock within the jet, this spiral hump, not only directs the reverse flowing water up the jet-bowl-tube, but also induces a counterclockwise spin to aerate it and keeps another 88 tons in the lower diagonal motionless (static). The reason it acts as a shut-off is, that water cannot flow in two directions in the same tube at the same time! When this action ends, and because the air pressure in the lower tank has been released, the check-valve at the entrance of the lower diagonal will open and new air and water will run down into the lower tank, bypassing the now motionless water in the jet-bowl-duct, compressing it until the check valve closes again, and with the help of a new vacuum from above, this action will repeat until a sufficient

head builds up in the upper diagonal! The head in the lower diagonal is constant, while the one in the upper is variable. The lower diagonal holds 88 tons of water, while the upper one has a capacity of 300 tons. The whole pump when full holds 600 tons! "Modern hydraulic engineers, have a long way to catch up with the ancient ones," wrote Kunkel.

When a sufficient head in the upper diagonal is reached, the vacuum can be released by opening the provided vent, allowing air to enter. The gravity of the accumulated water, will push downward, closing the buoyant valve (trap door) which shuts off the jet-bowl-tube with a sudden jolt. The check valve to the Queen's chamber opens and the water is forced into the upper air tanks until it cannot be compressed any more, its back pressure closes the upper check valve, and the compressed air blows the water up the discharge tubes to be released over the North and South sides of the Pyramid, as for Egypt there are no records of rainfall at all!

It is not known how often during a day, the upper diagonal was filled and discharged, that means how many times per day, 200 tons of water (as about 100 tons each time may have remained), were sent into the atmosphere? In this part of Egypt, strong North to South winds prevail, which would carry the moisture created with them, and when they hit green and cooler areas, the moisture would condense and fall as rain, watering the less fortunate part of Lower

Egypt, and on calm days, sprinkle their own vicinity. Herodotus said, "It embodies all the wonders of physics known to man, and the King rewarded the engineer who built it by having him sit at HIS RIGHT HAND." However, to Kunkel

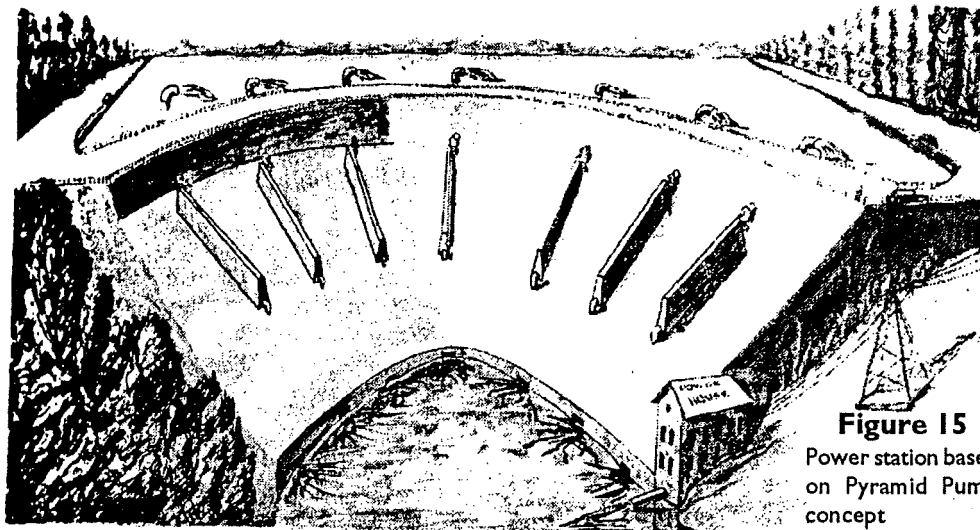

**Figure 15**  
Power station based on Pyramid Pump concept

it was a far greater significance, to him it was a monument to all MANKIND, a monument to "MAN'S FIRST VICTORY OVER MATTER!" But nothing lasts for ever.

In Herodotus' time, Egypt was occupied by the Persians, and some time after him, probably during a high water season or an earthquake, the Nile busted over the 2,000 year old dam, spilling the accumulated mud, including water in the canal and Lake Moeris, as it was designed to run backward into the river during dry season, flushing all debris down into the delta and burying the remains of Memphis under 50 to 60 feet of mud. The only existing and mute witness of this catastrophe, is the "ROSETTA", a black basalt tablet, bearing parallel inscriptions in Greek and ancient Egyptian characters, which was found in 1799 on a muddy Mediterranean beach near the town of "Rosetta", a long, long distance from Memphis where it was kept.

### VARIABLE PULL OF GRAVITY?

There is an other riddle of the Pyramid Pump. The entrance to Cheops Pyramid is on the North side, and descends toward South, like all other Pyramids do, but others have no diagonals going upward, only the Grand Gallery ascends from North to South.

Ancient Egyptian hieroglyphics contain a quotation, saying, THE NORTH GAVE POWER, AND THE SOUTH WAS GRACIOUS TO HAVE RECEIVED IT! Some scholars argue that this means the pull of gravity on water in a duct, is greater from true North to South than in any other direction? Kunkel

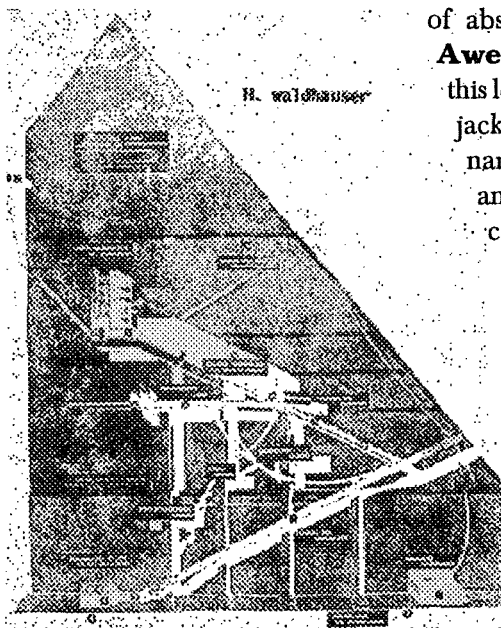

body cannot attract another negative one. Probably the Egyptians knew this force?

### KUNKEL'S HYDRAULIC RAM PUMP

It took over four years to get the patent, modern gadgets had to be added to conform with certain regulations, but it is still identical to the original pump. (Figure 13). For a complete patent write to the U.S. Patent Office in Washington, D.C. Of course this one does not use fire to create a vacuum, an electric motor does the job.

Even after receiving the patent, Kunkel still had a hard time to find someone to agree with him. Copies of the patent had been sent to most State Universities, Research Centers, archeological societies and museums, but only a few replied, why?

Author Josef Cater, a physicist himself, has an answer for that. After he got disillusioned with academic physics, he came to the conclusion, that they are incapable of abstract thought, and in his book—**The Awesome Force**—he explains, "Those on this level seldom escape the academic straight jacket, their thinking is generally restricted to narrow channels, as prescribed by authority and text books." (This applies to the medical community as well. A.Z.)

Only once, when Kunkel showed his pre-patent drawing to a Professor of Hydraulic Engineering, his answer was, "Young man, this pump will pump far more water than you think!" One possibility of how to apply the Cheops pump in modern times became obvious in a suggestion by the late Robert Spencer, Dean of the school of engineering at the University of Delaware in May 1933, in which he said, "If

Figure 16  
H. Waldhauser

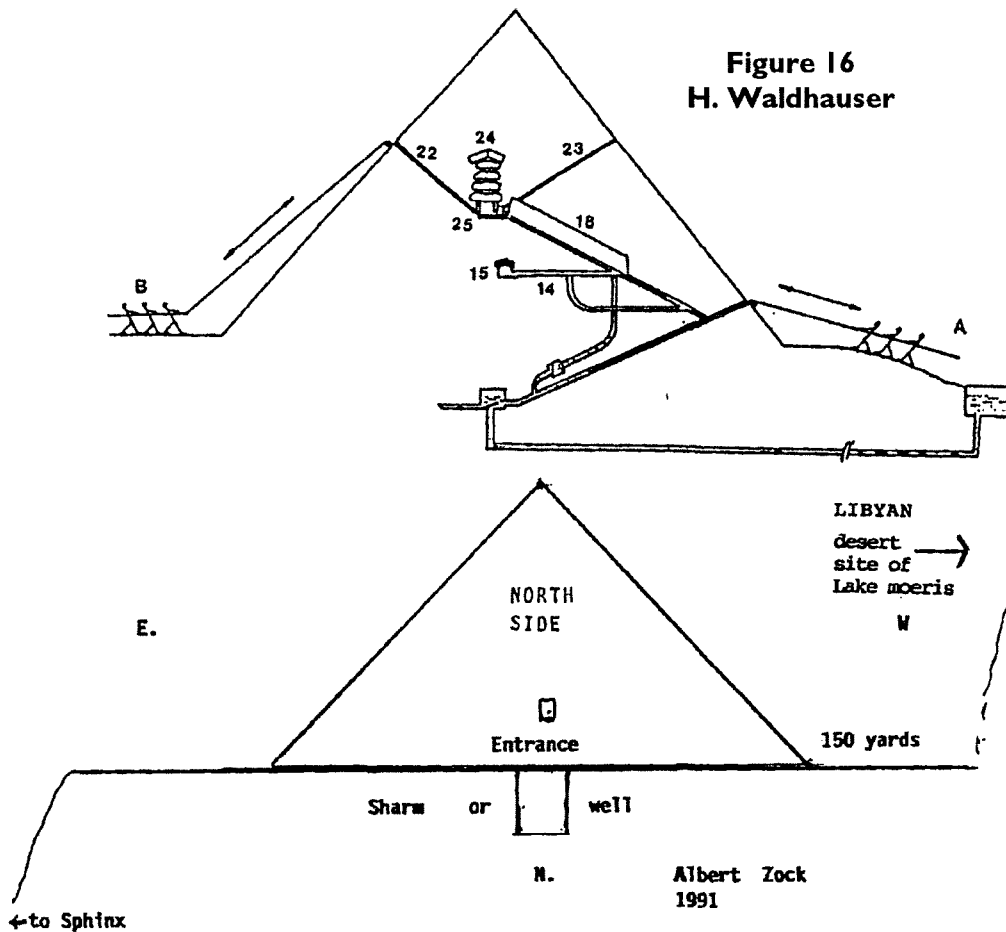

dam in Figure 15) would be embedded in the concrete.

The Egyptians used oil drenched wood which burns slow and pollutes air. Today we can use gases, the way they are used in cremation. Gases give a much stronger and cleaner flame than wood and will consume air faster, speeding up the refilling. Further, two or more pumps can work in cycles, like a two or four cylinder engine, feeding one turbine without interruption.

### SELF LOADING?

Let's solve one more riddle. The Aswan Quarry was situated where today Aswan Dam is, and King Sanusert build a fairway around the second cataract which probably was a series of water locks for

tubes are made big enough to run a boxcar through, and everything else is in proportion, it should generate enough power to throw a stream over the top. A bundle of wood should operate it for a day." Thanks, Dean Spencer! The above statement was made in 1933. Today, with all the new materials it should be easy to utilize this environment-friendly knowledge and get rid of the dangerous and more expensive atomic power. It also saves water by recycling it over and over, as nothing gets heated or contaminated. It could be the ideal solution, especially as small reservoirs are needed. The only loss is through natural evaporation, which a brook can easily compensate. Such plants could even make their own hydrogen gas, something the ancient Egyptians could not. It takes only a small electrical charge and some metal plates, submerged in water. At the 1986 World Fair in Vancouver, B.C. Can. Mercedes had a car on display having its own Hydrogen gas generator right from the factory, as an alternative choice of fuel, just turning a switch! What has happened to it since then?

### CHEAP POWER FOR ALL

Flat, inland cities may have their own power and heat. In actual practise the long narrow tanks (see diagonals on

military purpose. This led Kunkel to the conclusion, that water was introduced into the quarry during the summer flood. That means, the Egyptians had time and opportunity to load the heavy "Obelisk's" or what have you, for transportation on barges, as they stood on dry ground. Then, when the flood came, the water lifted the barges and they could be shipped down through the water-locks to the Pyramids.

As very often in history, an outsider of the scientist elite, in this case, a craftsman Herman Waldhauser, of Steyr in Austria, had a similar hunch, that gave him no rest. He too, studied Herodotus. Finally, with financial help of three local sponsors, and with his co-researcher, air pilot Arshraf Solimen from Egypt Air, he took off to Cairo and reached the Pyramid on Easter 1977. Waldhauser's pump has the same valves, air-tanks, etc., however, it does not work with a vacuum by fire, but with pistons pulled by ropes. Figure 16 shows two groups working in tandem and a model, built from Plexiglass and driven by a small electric motor makes it easy to observe its play-like function. After receiving Waldhauser's report, I sent a translation to Kunkel. Mrs. Kunkel informed me that Edward passed away, about two months prior to my letter.

*finis*

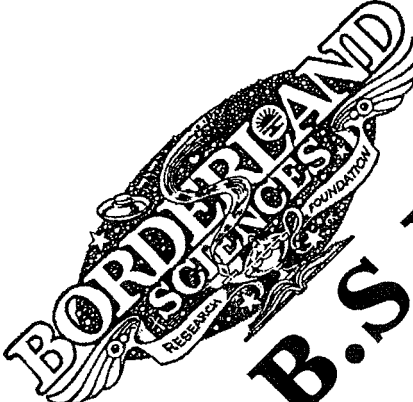

**THE B.S.R.F.  
BULLETIN BOARD**

★ ★ ★ ★ ★

**LETTERS**

**THE PAPER DOCTOR**

In the first issue of 1993, page 41, is a book review by Peter Lindemann about the Paper Doctor. I would like your help in getting a copy. I've written to the author and also called three times which was answered by a machine which said he would call back. No calls or letter. Which brings me to you. Is BSRF going to carry this book? Or can you help me get a copy? Thanks. Best to you,  
R.T., Penn.

Unfortunately, **The Paper Doctor** is not available. If at any time in the future this book becomes available we will distribute it through BSRF. We live in a time where the best of information is the hardest to get. Yet our task is always to find the best. We'll keep you posted.

**R. MURRAY DENNING, ESQ.**

I have read your 1st Quarter **Borderlands** — and whilst approving very much the new glossy presentation, I was also delighted to see you had featured Murray and his ideas and range of study inside. He would have been so pleased. Nobody has much of an inkling of the range and depth of his studies and practices — spiritually speaking — the hardest period and the most disciplined coming in the last ten years of his life. So, thank you again!

I hope the improved **Journal** brings its own rewards to you ... efforts to spread knowledge and stimulate interest. In other words that you go on from strength to strength — but don't overtax yourself — it's very soon the result of over enthusiasm and long hours. Add the extra mile on to the next day sometimes!

You may be too busy to write to me — not to worry. I just wanted you to know I appreciated your inclusion of Murray in your newly born publication.

With kindest regards,  
Annice Denning  
Chesham, Bucks, England

Nice to hear from you. We will always promote Murray's radionic work as he had a clear view of the subject. He wanted all radionic practitioners to take some form of standard medical training to be more familiar with human physiology, and he was also astute enough to realize that by using a pendulum over a rubbing plate one was mixing radionics and radiesthesia — hence insulating themselves from direct radionic contact with the witness by using two systems of detection. This important point is long lost on today's 'psycho-tronic' field that lumps everything under some vague psychic ability. Thus, our willingness to promote serious, clearminded work.

**STAYING WITH IT!**

I wouldn't be without your magazine, I've belonged since the 50's. Keep up the good work, love ...  
Mary E. Fort  
Jacksonville, Florida

Thanks... Stick around with us for at least another 30 years, life keeps getting more interesting.

**TOO COOL**

Yes, I would like to renew my subscription to **Borderlands**. Yours is one of the coolest magazines I've ever read. I'm very impressed with the broad range of alternative information you offer. Not only do you cover alternative healing, physics and other sciences, but you offer alternative historical theories as well. (November-December issue with the Chaco article was VERY thought provoking.) Keep up the good work!  
Ken Moskwa  
Lakewood, Ohio.

**THANKS**

I like the **Journal** and the many improvements. I miss the "letter" section (when absent).

I would also like to see more health related research, especially in the electromagnetic field and in particular, Lakhovsky, ????, Tesla, Rife, etc. I think you get the idea (and sources).

Thank you again for the push to get the improvements. Have a good rest-of-the-year.  
Sincerely, Dr H E Blair  
Palatka, Florida

**IMPRESSED**

I have been impressed by the quality of your articles and the open attitude of you who are in charge. And I appreciate the upbeat tone of the editorials, etc. Thanks.  
Mrs. Marion Snipes  
Tyler, Texas

**GOOD SHOW**

The quality of the articles has improved eminently. The focus and scope is being defined. Good Show.  
Frederick Springate  
San Marino, California.

**VERRRY INTERESTING**

Thanks for the *most* interesting read I get in the mail. Enclosed is my check — and keep up the good work.  
Sincerely,  
Kay Hetrick  
Absecon, New Jersey



**THE ETERNAL IN US**

The confusion among teachers of regeneration and control of the many human components is only understandable when we can go to the foundation principles involved. As simplistic as it may seem, the spiritual avatars like Jesus were right. There are two basic operating systems on our planet and as long as the false 'reflection' system runs this world, truths will be hidden and repressed until the individual crosses over to the true system of light.

As humans reject unethical actions of the dark path and make a true effort to be guided by their Creator and her laws, they can make progress at an astonishing rate. A new cycle is commencing and our whole planet is swimming in new energy bands and potential. The simple keys to tapping into such energies and gaining what some have called cosmic consciousness or 'flowlines' takes time and effort. It requires a constant battle against

negative thought contamination. Eventually, the inner phone lines to the soul and higher level knowledge bearers open up and answers on all subjects can flow in to the brain.

Since the 'reflection' or domination system is the opposite of the Creators 'light' or choice system, we must follow higher spiritual precepts and reject any great love of things of the material world. Eventually our vibes raise to more closely match those of the higher spiritual realms and we gain our flowline.

The schooling we are going through is designed to show us the futility of remaining in the reflection or domination system. As the present 3rd dimensional tests and lessons come to a close, those who rise above materialism can rise to the next 5th dimensional experience. Eternal life and body rejuvenation are not only possible but are becoming easier as we change planetary vibrations. Many new and powerful energies make flowline and mental

manipulation of matter easier as each year passes.

Note: To prepare humanity for the separation and new cycle, most persons will soon lose most of their flashy playthings. By the turn of the century those who have earned their wings through spiritual action, will have access to awesome technology and mental power. We can see this separation and testing process taking place all across the planet.

Al Fry  
Incredible Inquiries, P.O. Box 2207  
Garden Valley, Idaho, U.S.A., 83622

**SUPPORTING MEMBER!**

I am sending another supporting subscription to cover the next twelve months. I am very glad that my last supporting subscription was well appreciated and that is one of the main reasons why I am sending another one. I will always want to give very good support. I will certainly look forward to hearing all about the exciting information that is being

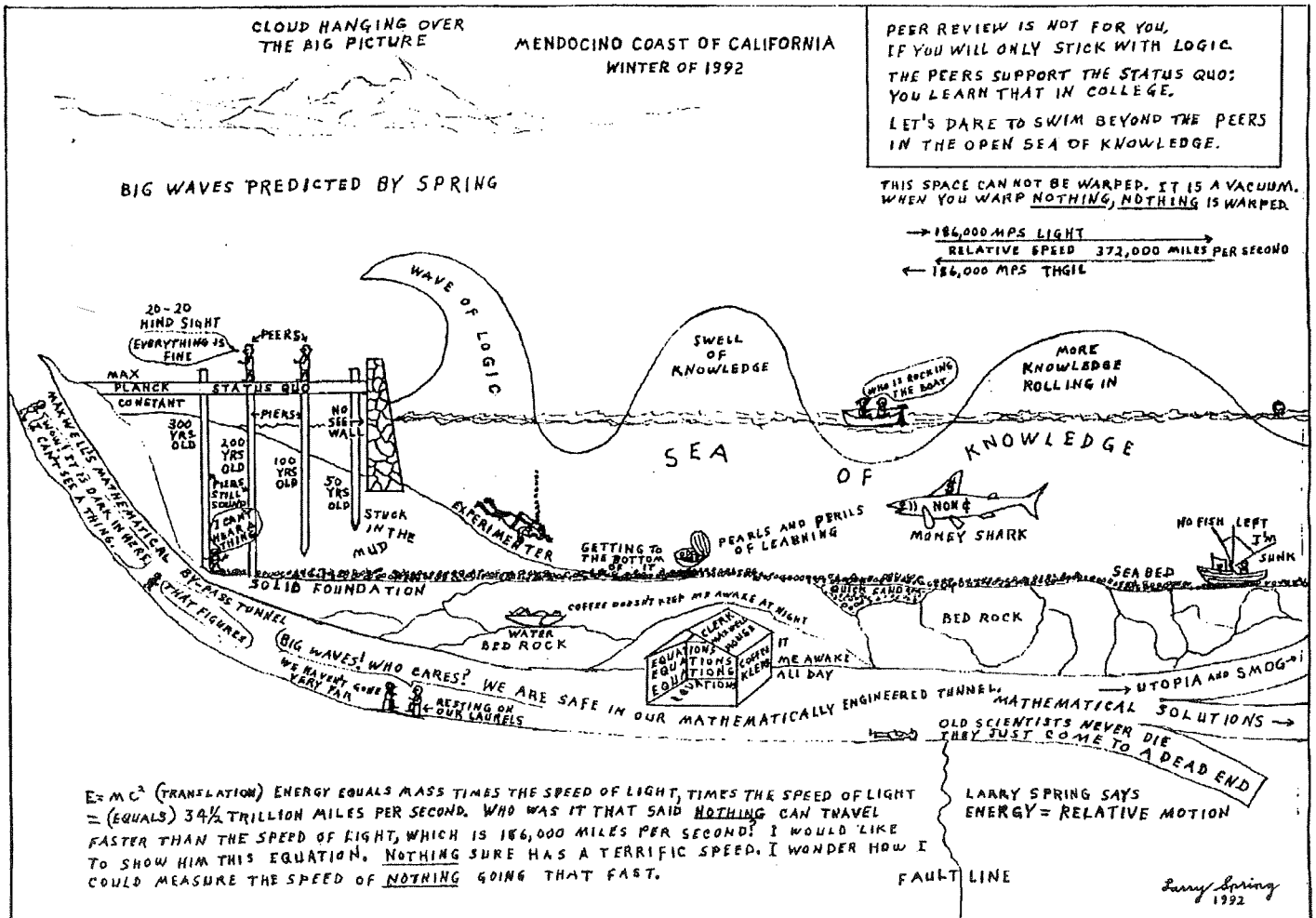

worked on at present. I think it is a good idea to have it changed to *Borderlands — The Crossroads of Science and Spirit*, and have it quarterly. I'm also glad that the publication is being improved. I certainly do appreciate the invitation to spend another year with you all. I would always want the renewal notice to come when it is time.

Yours sincerely,  
Andrew Barclay,  
Victoria Australia

#### VITIC POWER

I am reading with great interest the work and observations recorded in the book that came with the Vitic Rods. It's great!

Do you have any current observations/instructions on the what/how/why/how much (\$) department on magnetic healing. I would like to purchase it.

The Vitic Rods are fantastic! It's been the best investment ever for me. Immediately I felt a steady stream of energy through hands and arms. I am studying chi development and meridians — so soon I can expect to be fully super-charged.

It has helped with a mild case of depression as well — because in one week's period, I lost my job AND my family left me. That's a biggee! Anyway, my estimation is that the rods have lessened that depression — and combined with exercise and nutrition, I'll rise out of this slump just like any other! Thanks for your great books, research and products. Please let me know about my request. Thanks!

Dave Johnson

Yes, the Vitic Rods are amazing. Our feelings have ranged from nothing to electrical streamings. Much research needs to be done into the effects of Carbon on the system, and how it can be increased with natural magnetism, What is in our catalog and in the pages of this magazine is what we have available. We get hundreds of requests a year asking us what else we have *besides* what is in our catalog!

#### BIOCIRCUITS & RADIONICS

I am happy to renew my subscription to *Borderlands*. I find it a very informative read.

I recently read a book by Leslie Patten called "Biocircuits" where she discusses experiments by Peter Lindemann, who I noticed writes

for your journal. One of the experiments mentioned deals with hooking up a Biocircuit to a Radionic machine to relieve symptoms of herpes simplex.

I am very interested in learning where I can obtain a Radionic machine, how do I hook it up to a Biocircuit, how to use the Radionic machine and how to determine which frequency relates to which disease.

If you could assist me with this I would be extremely grateful.

Anthony Filipovich  
Ontario, Canada

Some of the information you seek was shown in a video interview with Peter Lindemann titled "Radionics & Natural Healing". We quit mass producing it because of the quality, but the information is excellent ... We will copy in on request for \$23pp. Perhaps more can be extracted on this subject from Peter ...

#### PYRAMID PUMP

Last night (Friday, May 28th Radio Free America interview with Tom Brown) I heard mention of Edward J. Kunkel and his Pharaoh's Pump.

Mr Kunkel died a very painful death, with liver, pancreas and intestine problems, in April of 1979, shortly after writing his autobiography "One Bright Day" in 1978.

Mr Kunkel was a friend of mine and I have most of his work and many personal letters. For the most part, his work went unnoticed (at least here in the U.S.)

In the 1970s, I did several articles concerning his pump theory. At the moment, the response was overwhelming but then faded away.

His fondest dream was to have his theory recognized, if not accepted.

I am enclosing some material concerning the pump and, if, (15 years later) you think it would interest your readers, please feel free to reprint, excerpt, edit, etc.

Lee Walsh

Thanks for the info ... it's in our pile of important materials to evaluate. We'll use what we can in future issues. Tom Valentine told me (on the mentioned show) that he saw Kunkel's pump working many years ago. At first I thought this was all just a curious theory ... now it appears to be an important clue to the past.

#### RADIONICS

Find enclosed cheque for US\$15 as my sub for 93-94 journal. I have only sent \$15 this year as I retired last October, and I am now 65, but would still like to keep up the journal, helps to keep the old gray matter ticking, and I like to keep up with new things in the Borderlands area.

Now what I would like to ask is could you not do an article, "Back To Square One" with Radionics? For example, with the Drown method, why do they show a meter of some type, on her instruments if they do not use electric power, both in diagnosing and treatment? Also do you have the notes for Drown Brain Activity Centers? as mentioned in the article by P. Lindemann May-June 1986 JBR. I also have found as he said that the treatment of RNA does help other treatment to enter better. I have the rate book from Denning, England, but cannot find the B.A. Centers in it at all.

The next thing is it at all possible to obtain schematics or patent numbers of Drown long and short wave instruments together with the Hemorrhage Control Unit Model 998? Maybe you could put the above in the Journal, some other reader could help? Also other readers may have some of the Drown Radio Therapy Journals, if so could they send to you for printing in *Borderlands* more information on the 12 Cranial Nerves. So far I can only find notes on the first three nerves, the others would be a great help.

This is the last one, is there any special reason why Drown used her type of dial with a single wire and 11 equal stops on the face of the instrument, instead of a pot? I know her instrument had only 1 ohm resistance where as most modern ones have all sorts of resistance the only one close to Drown was De La Warr, with his split roster[??], but who now uses pots, if Drown was right, her rate Nos should not work on pots, the rotation angle is not the same, 10 on a pot, is 8 on a rotation, and then Malcolm Rae with his 44 dial numbers, and your own version of Drown with pots and switches or is it all in the mind?

With such things it makes for more confusion, if it is only a belief system then it does not matter what is used.

Well that is enough for now, but there is a lot more. If you can help in any way at all with the above I would be most grateful.

Thanking you, best wishes,  
Gordon Willison,  
New South Wales, Australia

We'll publish any good materials on the subject we can get. We have published all technical info on Drown from our files. From your question on dial construction it shows you are grasping the problems associated with the misunderstanding of what radionics is. Most instruments are operated as psychotronic devices, wherein the psyche directs the force. Radionics is based on physical/etheric structure relationships and the exact patterns must be followed. A "Back To Square One" article is a great idea ... We'll keep it in mind.

#### BEYOND MATTER

I have now got additional copies of my works "Beyond Matter" recently published. I shall be obliged if necessary advertisement for this book is made in the Journal of Borderland

Research magazine. I am sending separately some copies of "Beyond Matter".

With best wishes.

Yours sincerely,  
P Tewari, Kaiga Project  
Kaiga - 581 400  
Karwar, Karnataka, India

#### MWO STUFF

This communication is primarily in response to Peter Lindemann's instruction in his "FIZIX KORNER" article regarding the true Lakhovsky multi-wave oscillator design and construction by BSRF, as well as its subsequent availability to BSRF members later this summer. He advised that we contact you to apprise you of a desire to obtain an instrument.

I had planned to obtain one of Klark Kent's imposter instruments and modify the output in a way that would utilize the rare gases, as Klark agreed to, quite cordially. I have been planning also to do similar

modifications concerning his "Rife" Frequency Resonator (those steel footplates are a joke ... was that John Crane's or Bob Beck's idea?).

I have felt strongly since first reading Einstein Doesn't Work Here Anymore in 1983, and also later reading The Cancer Cure That Worked in 1987, that the "inert"/rare/noble gases would provide or yield the ultimate curing agent for inducing really effective healing, even within individuals who couldn't manifest enough faith to heal themselves via the mind-body relationship. Of course, it was this relationship that caused the illness in the first place (imbalance), even extending to the point of negative karma. It could be more than chance or synchronicity that Barry Lynes' book was published in March, 1987, the same month that I had a vivid dream about blueberries (\*anthocyanosides/glycosides, anthocyanic acid, kills polio viruses and rejuvenates the body in various ways, and E. Cayce said that blueberries contain a special "property") and then (3 days later on my birthday of March 3rd) was "given" the key to the rare gases technology. Hence, I feel that these 2 items represent the one-two punch regarding rejuvenation and regeneration in the human body, and my research since 1987 has convinced me of this theory ... no, belief. Neptune, ruler of Pisces, involves dreams, so all Pisces personalities should take their dreams very seriously because they can provide good guidance to supplement the natural and extraordinary intuition of Pisces, which obviously helped Einstein, Cayce and Steiner.

You have for some time been calling for documentation of any and all medical research work and results, as have been and would be obtained from both "Rife" and "Lakhovsky" instruments and equipment, regardless of authenticity. Of course, one has to start somewhere with the investigation, but you know that we need to emulate Rife's and Lakhovsky's instruments as much as possible before updating or modernizing them. I'm especially interested in the changes and direction of Peter Lindemann's current work on the MWO and hope that he'll expand his imaginative forces to include the Rife Frequency Generator

Solar Cycle 22 Compared to the last 3 Cycles

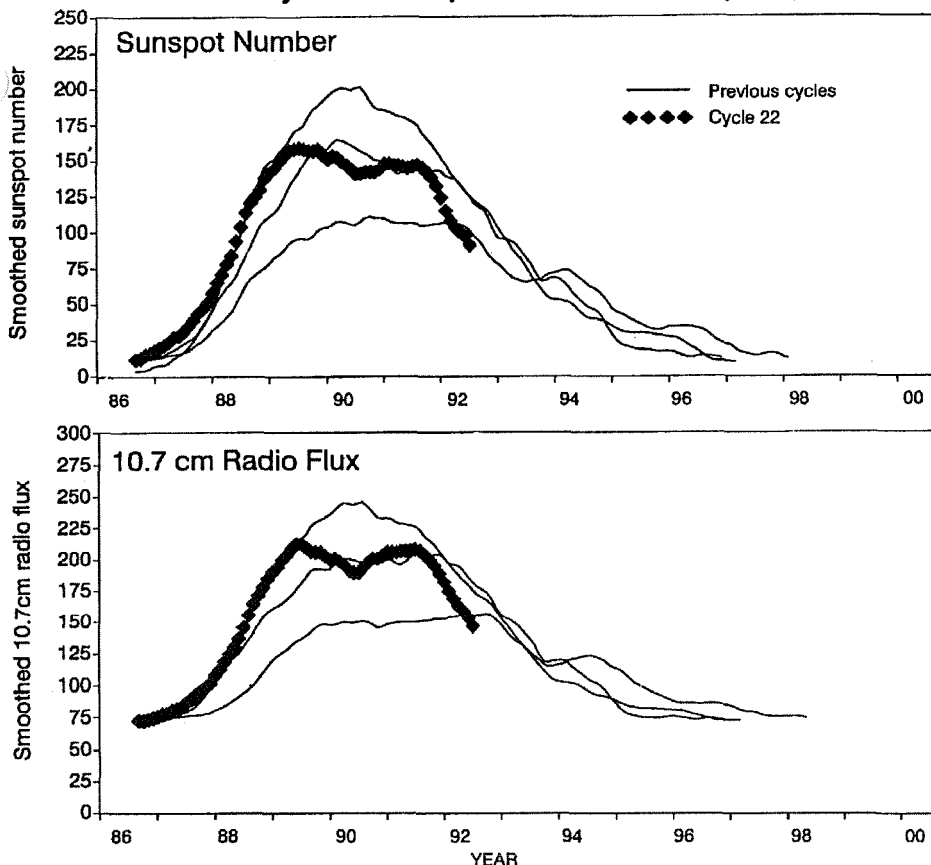

(Beam Ray). You don't get a "ray" from an electromagnetic field, but you can from an X-ray type of tube that's filled with a rare gas(es), which certainly is the pregnant clue in Rife's system.

William P. Maynard  
Fair Haven, Vermont

Keep us posted on your researches. It was John Crane who came up with the footpad idea from a misunderstanding of Rife's work — Beck just parroted the false cause many years later. Many of those who make &/or sell equipment are not interested in the facts as they would cut seriously into sales. We have also just received further information that we have been on the right track with our Lakhovsky research all along, our claim that Beck's device was not copied from an original Lakhovsky device is upheld. More on this in the future when we have time to correlate it all ... The antenna design incorporated music, planets, metals ...

#### MARK SIMPSON, R.I.P.

I received the enclosed letter today, which you should find of interest. I have been corresponding with Mark the last few years re: Rife research. You may wish to run it in your "letters" column.

There are some good Rife-type units available. I firmly believe that pathogens can be killed at the correct frequencies. The problem remains that no research is being done with a Rife-type optical microscope. All published frequencies need to be checked and/or corrected with modern equipment.

Lowell K. Pope  
McKinleyville, California

March 4, 1993

Dear Correspondent of Mark Simpson:

I am enclosing your recent letter or other correspondence (along with your check or money order, if any) to my son, MARK SIMPSON, who died of AIDS on Feb. 25, 1993.

Mark was diagnosed HIV positive in the early spring of 1988. At that time he was, as he had been for some time, active in research in alternative medicine, especially as related to the life and work of Royal Rife and electronic frequency technology and treatments.

Mark's involvement in the electronic frequency business turned out to be a truly fatal attraction. Because of it, he spurned traditional,

proven medications (AZT, DDI, etc.) available which could maintain his immune system, and he did nothing for his condition except electronic frequency "therapy", peroxide baths, herbal treatments, and other lunatic fringe practices. For a while he felt quite good, and probably believed that the idiotic treatments were helping him. Of course, most people who are HIV positive are perfectly healthy for a long time. But all the while, his immune system was deteriorating, and when he did start feeling bad last September, all the symptoms of full-fledged AIDS developed rapidly: rapid and permanent weight loss, serious dementia, thrush, skin eruptions and disorders, chronic and acute diarrhea, and exhaustion. By the time we convinced him to do something for his discomfort, at least, it was too late. His T cell count was down below 15, and it was just a matter of time.

I write all this not because I think I can say anything or do anything to change the attitude of hard-core, lunatic fringe, alternative medicine cranks. Nothing can do this: they just have to die. But maybe some of you people who are writing to Mark are ill, desperate, despairing, and in pain. And maybe these latter folks will think about this: Mark Simpson knew as much about Royal Rife and electronic frequency machines as just about anyone. So see what all this did for him.

A.S.  
Mark Simpson's Father

We were sorry to hear of Mark's passing. We corresponded and exchanged information. We were responsible for getting Mark to realize that no direct evidence exists indicating that Rife used square-wave pulses over electrodes. Certainly this approach will alter the system, as electricity in its many forms is an organic system alterant, but it has nothing to do with Rife's amazing work blending complexes of frequencies, from audio to shortwave. As AIDS is possibly not caused by a pathogen, there is no "magic bullet" that will affect it. We certainly understand Mr. Simpson's pain and anger at the situation, but AZT only promotes the health of the British drug company that makes it, Wellcome. Even the establishment Economist reported that in massive trials of AZT it performed poorly and it appeared the patients would have done better without it. I think the Rife research did Mark a lot of good.

It gave him hope, it increased his awareness, and he helped a lot of people discover that there is more to life than the official story. May his soul be eternally blessed.

#### RADIATION MYSTERY

Commend you on fine job you are doing with BSRF Journal. It's totally a labor of love on your part & it shines through beautifully!!!

I've lived in the southern California coastal area for over 40 years and 99+% of the time enjoy marvelous health. During Jan 93 for few days which stopped and began again all of April, May to present mid-June (full time) have been experiencing shooting, searing burning pains/aches in legs to ankles with swelling, lower body weakness and great discomfort. I had not done any physical injury. I came upon some high-frequency water end of May which aided to greatly remove pain, however, the rest of the symptoms continued.

This very morning I received the answer to "cause" of these body afflictions from a radionics practitioner who I have consulted with from time to time over the years. Uranium fallout contamination is invisibly pelting sections of S. California.

This note is to alert other BSRF Associates who may have been suffering similar afflictions who aren't able to find answers of 'why'. The body symptoms are similar to some of reports by military personnel who served in Desert Storm which medics are reporting new, strange disease/afflictions supposedly from "unknown cause", but are apparently from depleted uranium used in armor-piercing shells used in that conflict.

Hot tub soaks with lots of sea salt aid to pull some of the radiation out of the body which will bring ease, faster.

Thank you for sharing this information with readers who may be wondering "cause" when they know they've had no physical injury, etc. "Relieved" in San Diego

Thanks for your report. Perhaps this mystery can be extended to the bizarre nerve ailment in Cuba this spring which caused blindness and paralysis, and/or the mystery illness killing people on the Navajo Reservation in the American Southwest. And Peter Lindemann's recent

articles on ORANUR and the atmospheric emergency caused by nuclear radiation will provide further clues. Any further info from Borderlands readers is most welcome.

#### STIRLING MOTOR

Thanks for prompt response! In exchange I send some feedback, but my name not for public. The Stirling Motor Concept is fully solved, the Swedish Navy have submarines with Stirling Systems. The submarines have their capacity to operate underwater extended dramatically compared to the Diesel concept. Still the propeller is powered by electric motors but instead of Diesel motor to run generator now the Stirling motor is working and the need for air via surface is eliminated. Kockums shipyard in Malmo have know-how of Stirling motors.

I recall an article about a bus with Stirling motor, can't remember if it was a Volvo or SAAB experimenting.

Talking about motors why not check your 'neighbor' Dr Rudolf Gunnerman in Sparks, Nevada and his water/gasoline fuel — A55 (55% water, 45% gasoline!) for car motors. This is for real, he is a scientist...

There is a tape from Radio Free America with Tom Valentine of January 15, 1993 covering a lot. Phone 813-572-9209 for tape. Tom Valentine, Box 75545, St Paul, Minnesota 55175. No address or phone for Dr Gunnerman, he is busy working. R. N., Sweden.

#### HUNGARIAN REPORT

Thank you for publishing my conference report in the latest issue of your Journal.

I would like to enclose further contribution on magnetic healing device which came from the American Apollo Project.

Since American people made the project to complete success, they deserve to be notified about the beneficial implication of this project concerning their health. Therefore, I decided that I send this information to you so that health professionals can utilize the research which Europeans carried out.

I look forward to continue working with you in the future as well. G. Belovari, Budapest, Hungary

The information enclosed was on Ludwig's ELF pulsors, which were quite popular in the mid to late 1980s here in America. BSRF publications carried information on them at the time, including how to build. We quit pursuing the field when we scrutinized the information and realized that the leading spokespersons were mixing up the evidence and lumping the Oregon Mystery Radio Signal and the "Soviet" Woodpecker, two quite discrete phenomena, into the same popularized story. But, in fact we hypothesize that these signals were intentionally confused to misdirect research and blame the Soviets for questionable research being done on the American public. We are open to clear, verifiable research on ELF effects on organic systems.

#### NO GODDESSES IN EDEN

I just read your half-sentence review of my book, "The Gods of Eden," in your Second Quarter 1993 issue of "Borderlands."

I suppose that my book could be labeled a tome about the so-called "sinister alien conspiracy," but I would have hoped that you would at least give the book credit for presenting interesting historical facts and UFO reports not presented before in any UFO related book. I tried to write the book so that people who did not agree with the overall hypothesis could still use it as a research tool into the subject of historical anomalies. As I wrote on page 444, "I realize that many of the ideas I expressed have probably been as challenging for you to deal with as they were for me. If nothing else, I hope that you found some of the information in support of my ideas interesting. I have always enjoyed new perspectives and I believe that it is important to be willing to express them."

As for the statement that my book is written "from the usual patriarchal world-view" ...Huh??? Come again...???

Keep up the good work with your interesting, if often contentious, magazine.

Best wishes,

William Bramley  
Author, "The Gods of Eden"  
San Jose, California

Thanks for your comments. Our RECEIVED column lists books *received* and says they are *not reviewed*. We have hence renamed the column to reflect the treatment that the received books get. But if "Gods" of "Eden" is not

evocative of the patriarchal basis of the Western world view then what is? That is where it all supposedly started ... But we'd like to see a good review of it ... all we need is a good reviewer ... Any takers?

#### DEEP DELTA

Thank for mentioning Deep Delta in the 1st Quarter 1993 issue. I found it at Cody's Books in Berkeley on Telegraph Ave at Haste Street. I was thoroughly impressed with your article entitled *That Which Is Eternal In Us Must Be Awakened*. The amount of personal research must have taken 20 years to do.

Enclosed is a copy of Sonic Transform. This is a brain hemisphere synchronization tape. Headphones are required to feel the effects for maximum benefit. People can send a SASE to receive the TTM catalog for free. TTM is dedicated to brain sync tapes at an affordable price. TTM believes this technology should be made available to the public. Brain sync tapes are an effective way to zap stress and boost the flow of balanced energy with the body.

Thank you for doing such a great job with Borderlands. Good luck with publishing. If there are any questions that you might have please feel free to call and ask (510-658-2560).

Musically yours,  
Michael Mantra, Tranquil Technology Music, P.O. Box 20463, Oakland, California 94620

Rather than 20 years, the research for my "Eternal" article probably took at least 20 lifetimes, though I only remember parts of this one ... Thanks for Sonic Transform ... We'll check it out.

#### ANTIQUÉ RADIONIC EQUIPMENT

I'd appreciate it if you could run the following for me: "1940s Radionic Equipment for sale. Beautiful wood cabinet console and separate additional treating units. Please call 1-310-677-7002, 10 AM to 10 PM California time."

Thank you.

F.M.J. Levenston, D.C.  
Inglewood, California

Questions, Comments, Complaints,  
Passing on information!!!! Send it in  
to the BSRF Bulletin Board and we'll  
take it from there!



# Judged by its Cover!

A listing of books, videos, magazines, etc, received for review ... full reviews of selected titles may show up in future issues depending on available time, interest and surging cosmic forces... Here we just list 'em and judge them by their covers...

○ **BIOLOGICAL ANOMALIES: HUMANS II** — *A Catalog of Biological Anomalies* compiled by William R. Corliss, Sourcebook Project, P.O. Box 107, Glen Arm, Maryland, USA, 21057. This is the 13th volume in the Catalog of Anomalies and the second of three volumes devoted to human anomalies. This is another exceptional collection of rare and important data for the researcher. Believers in evolution will love to learn of the many problems with that theory in explaining the complex functioning of various human organs in relationship to their "forbearers" in other species. There is a good section on HIV and AIDS describing AIDS without HIV, HIV without AIDS, and other data we're not supposed to think about. This book is packed with information on many curious facets of human life: Electric and magnetic people, unusual body temperatures, body potentials correlated with lunar phase, blood polymorphisms, hemorrhages and astrology, health and weather, disease epidemics correlated with solar activity, spontaneous human combustion, limb regeneration, electricity in healing, and many other fascinating subjects. ISBN 915554-27-5, 297pp, \$19.95.

○ **THE LOST PYRAMIDS OF ROCK LAKE** by Frank Joseph, Galde Press, Box 65611, St. Paul, Minnesota, 55165, \$10.95. Rock Lake, in the State of Wisconsin, is a lake of mystery. Divers have long said that there were rock pyramids on the bottom of the lake, and in this book their existence is detailed and documented against a backdrop of remnants of a sophisticated Bronze Age culture which existed millennia ago in the American Midwest. Fascinating!

○ **THIRD PARTY RAPE** — *The Conspiracy to Rob You of Health Care* by C. Norman Shealy, M.D. from Galde Press, \$12.95, ISBN 1-880090-07-4. For sure many Borderlanders will find this title of interest. The American Medical Association News rejected an advertisement for this book in its classified section!

○ **ASKING QUESTIONS**, A Dowser's Series No 1, and **GEOPATHIC ZONES & The Iron Stake Method**, A Dowser's

Series No. 2, both books by Gregory A. Storozuk, 273 Summer Street, Seventh Floor, Boston, Massachusetts, 02210. These are the first two books in a series that will teach practical, basic dowsing and related arts. The books are brief, well illustrated, and to the point so they should make great books for anyone wanting to learn. Greg has been dowsing for over 16 years and offers seminars/workshops on dowsing, and also manufactures dowsing equipment. Send a S.A.S.E. to the above address for more information.

○ **AROMATHERAPY** by Viktor Blevi and Gretchen Sween. The cover says it is ... "A modern guide to the ancient art of healing through scent. The use of essential oils to: Reduce tension & stress, Relieve physical ailments, Promote well-being & peace of mind, A safe & 100% natural therapy." From Avon Books, 1350 Avenue of the Americas, New York, New York, 10019, \$10.00, ISBN 0-380-76429-6.

○ **WHEN TIME BEGAN** — The First New Age (Book Five of The Earth Chronicles) by Zecharia Sitchin. More physical gods from outer space stuff, but Sitchin's books are incredibly well documented and he is a true scholar of ancient texts. This latest from Avon books, \$5.99, ISBN 380-77071-7.

○ **KARMA AND REINCARNATION** by Dr. Hiroshi Motoyama. This looks to be a fascinating exploration of a topic that should concern everyone — our interactions and entanglements in reality. Dr. Motoyama has over a 1/2 century exploring these realms as a scientist, healer and Shinto priest. He has also invented equipment for measuring the energetic states of the Chakras (detailed in his book *Theories of the Chakras*, Quest Books). From Avon Books, \$10.00, ISBN 0-380-77213-2.

○ **YOUR HEALING MIND** by Reed C. Moskowitz, M.D. "Now you can learn the extraordinary mind-body therapies developed by [the author] in his Stress Disorder. Medical Service Program at New York University Medical Center. Using case histories from his pioneering work, Dr. M. describes his amazing successes in treating some of the most debilitating health conditions. Learn specific techniques for confronting: Anxiety, Severe allergies, Headache, Eating disorders, Backache, Infertility, Stomach disorders, Chronic fatigue, High blood pressure, Sensitivity to common foods and chemicals, Infection, Heart disease, etc..." From Avon Books, \$10.00, ISBN 0-380-71470-1.

○ **GET RID OF YOUR ARCHEOLOGICAL GARBAGE AND GET A LIFE!** A video interview with Joel Colman "a brilliantly gifted practitioner whose unique abilities help people to knock down the walls that are keeping them from finding true happiness". The interview is hosted by Gale Van Cott and is the first of a series of alternative healing tapes from Heartline Communications. Also received here from the series: **HYPNOTHERAPY - CHANGE YOUR MIND, CHANGE YOUR LIFE** an interview with hypnotherapist Ann Ahlin; **MASSAGE - THE BODY, MIND CONNECTION** an interview

## TESLA BBS

### ◎ NETWORKING

### ◎ RESEARCH

Electromagnetics  
Wireless transmission of power  
Transmutation  
Biomagnetics

### ◎ TEXT FILES

Nikola Tesla  
Walter Russell  
Tesla Turbine  
Free Energy/Zero Point  
Hyde/Swiss ML Converter  
Keely Vibratory Physics  
Cold Fusion  
Gravity Experiments

### ◎ PROGRAM FILES

Engineering  
Math  
CAD Tesla Coil Design

(719) 486-2775 Data

300,1200,2400 Baud (8,N,1)

with Michelle Prince. Videos are excellent instructional tools and these folks are making them available. All are priced at \$19.95 from Heartline Communications, 21119 Osborne St., Canoga Park, California 91304, phone 818-700-6370

○ **THE CREATION OF HEALTH** – *The Emotional, Psychological, and Spiritual Responses that Promote Health and Healing* by C. Norman Shealy, M.D., and Caroline M. Myss, Stillpoint Publishing, P.O. Box 640, Walpole, New Hampshire 03608 \$14.95, ISBN 0-913299-94-4. Looks interesting, hope to read it someday...

○ **AURA-Z**, P.O. Box 224, Moscow 117463, Russia, phone 095-925-7679. This is a well produced new magazine just received which bills itself as an "illustrated quarterly journal of ufological and paranormal phenomenon. Lots of interesting articles and they seem very much into verification through experimentation. Right on! US\$33/Europe, \$36/elsewhere. Credit cards OK.

○ **THE INTERRELATIONSHIP BETWEEN MIND AND MATTER** – *Proceedings of a Conference Hosted by the Center for Frontier Sciences*, edited by Beverly Rubik, Center for Frontier Sciences, Temple University, Ritter Hall 003-00, Philadelphia, Pennsylvania, 19122. ISBN 0-9633272-0-8, \$20, large paperback. A "multidisciplinary collection of papers, addresses, novel perspectives and research on consciousness at the frontiers of biology, engineering science, medicine, parapsychology, philosophy, phys-

ics, and psychology. Composed of 15 papers by distinguished scientists and scholars from 6 nations, this book challenges the notion of a split between mind and matter as well as mind considered to be an epiphenomenon of brain function." Quite a collection of papers from scientists who are working to expand their world view.

○ **SEARCH FOR HEALTH**, P.O. Box 75545, St. Paul, Minnesota 55175, phone 1-800-321-0416. Occasionally a really exceptional bit of information crosses our desks here. This new magazine, *Search For Health*, contains some of the most thoroughly researched alternative health related information rolled up into one package. From the damage microwaved food does to your system (documented tests in first issue will put you off ever using one again) to the damage done by plastic oils (partially hydrogenated) pervading our basic foodstuffs, on through clearly and openly investigated subjects like how ozone has worked in AIDS remission, and EDTA Chelation therapy, to name just a few of the many articles. Tom & Carole Valentine are doing a great service through this magazine and we highly recommend it to anyone who eats! A two year sub (bi-monthly) is \$59. Back issues are available for \$12 each. Tom is also the host of Radio Free America on the Sun Radio Network (813-572-9209). The show comes from a populist political point of view, and our worldwide readership will be pleased to know that Tom has many guests on alternative science and medicine. We pick it up at BSRF HQ on 7435 Kc from 7-9 PM Pacific time.

**Conspiracy, As Usual!**

Does the US have bases on the moon serviced by space shuttle launches from Area 51? What is the connection between Philip K. Dick and the Illuminati? Does Bill Clinton acknowledge a conspiracy theorist as his mentor? Was J. Edgar Hoover caught on film in the act of *flagrante delicto*? Did more than one set of tramps get arrested after the JFK assassination? If the new *Steamshovel* doesn't answer these questions, at least it asks them. As always, *Steamshovel Press* presents new challenges to accepted wisdom and consensus views. Available for \$4 plus \$1 postage from: *Steamshovel Press*, 5927 Kingsbury, St. Louis, MO 63112.

*Not available in bookstores where the conspiracy prevails.*

The new issue of *Steamshovel Press* has arrived! **Steamshovel Press Number Eight, \$4 plus \$1 postage (\$5+\$1 foreign) Subscribe! Four issues, mailed first class, \$20**

**Steamshovel Press**  
 "Candidly exposing the conspiracy game" JEFF MURPHY  
 Lars Hansen on J. Edgar Hoover  
 Sean Marston: UFOs at Area 51 & Meskhutov  
 Jim Marlier: Quigley, Clinton, Straight, & Reich  
 Stephanie Caranau: GRANSTONE  
 Secret Service Files on Mae Brunell  
 Phillip K. Dick & The Illuminati!  
 A. J. Wehrman: JFK & Hunt the Tramp

Name \_\_\_\_\_ Address \_\_\_\_\_ City \_\_\_\_\_ State \_\_\_\_\_ Zip \_\_\_\_\_  
 Begin with issue # \_\_\_\_\_ (No indication here means subscription begins with #8)

**EXPLORE!**  
 NEW DIMENSIONS

A bi-monthly journal of 80+ exciting pages exploring alternative methods in Health, Medicine, Energy and Physics

Non-toxic alternative solutions being used successfully for Cancer, Aids, M.S., Parkinsons, Chronic Fatigue and other illnesses

The latest research in free energy devices

We take pride in publishing leading edge information from All Around the World

**Subscribe today!**

United States	\$59
Foreign Countries (regular mail)	\$75 U.S. Funds
Foreign Countries (air mail)	\$100 U.S. Funds

**EXPLORE!**  
 P.O. Box 1508  
 Mount Vernon, WA 98273

206-424-6025 / 424-6034 (Inquiries)

**1-800-845-7866**  
 (Order Desk)

Send check or money order for your subscription or write today for a free listing of all articles to date

# STRANGE MAGAZINE

## FRINGE SCIENTISTS

Wilhelm Reich  
Nikola Tesla  
Jack Parsons  
Jacques Bergler

## AERIAL ANOMALIES

UFO Occupants  
Falls from the Sky  
Ancient Astronauts  
Cargo Cults

## FORTEANA

Cryptozoology  
Underground Mysteries  
Kirlian Photography  
Time Slips

## INCREDIBLE ODDITIES

The Crystal Skulls  
The Vinland Map  
Archaeomalles  
Crop Circles

## WEIRD SCIENCE

Death Rays  
Free Energy  
Electrotherapy  
Plasma Effects

For five years **STRANGE MAGAZINE** has been bringing its readers an open-minded look at the mysterious world of **Strange Phenomena**. Each bi-annual 64-page issue contains fascinating first person strange encounters, in-depth investigations, documented reports, and fascinating articles by top-notch investigators of the unexplained including John A. Keel, Loren Coleman, Mark Chorvinsky, Jerome Clark, & Vincent H. Gaddis.

Send check or money order to:

**STRANGE MAGAZINE:**

PO Box 2246, Rockville, MD 20847

4 issue subscription—\$17.95 (\$22.95 Foreign)

Sample Issue \$5.95

Please charge my: VISA      Mastercard      exp. date

NAME \_\_\_\_\_ card number

ADDRESS \_\_\_\_\_

CITY \_\_\_\_\_ STATE \_\_\_\_\_ ZIP \_\_\_\_\_

**Out of room, out of time! More coming next issue ...Tally Ho!**

# MEDICAL HYDROLOGY IN AYURVEDA

by Dr. E.A.V. Prasad

Professor & Chairman, Dept. of Geology

Sri Venkateswara University

Tirupati - 517 502 (A.P.), India

The Indian scripture, **Bhagavad Gita** ("Song Celestial") points out the vedic concept, Kshetra. i.e., body/field; according to this concept, the **pancha-maha-bhutas**, i.e., the five primordial elements [(i) **Akas** or sky, i.e., extra-terrestrial radiations; (ii) **Vayu** or gases, (iii) **Ap** or water (iv) **Prith** or earth or mineral matter, and (v) **Agni** or fire, i.e., heat or thermal energy) interact to maintain **Satvic** or balanced state in both the internal biologic environment of a living body (microcosm) and external environment of the geologic world (macrocosm). This concept has been substantiated by physico-chemical biology in Ayurveda (science of longevity) with a cybernetic approach involving the **Nyaya-vaisheshika** system of Indian scientific philosophy.

An Ayurvedic text, called **Bhavaprakasa** by Bhavamisra, provides important clues of medical hydrology utilising the natural waters, including those derived from vegetable and animal sources. According to the **Encyclopedia of Geochemistry and Environmental Sciences**, this science, referred as 'balneo-geohydrology', deals with finding natural water sources, including 'peloids' (i.e., natural substances formed by a geologic and/or biologic process), characterised by unusual physical and chemical properties which can be exploited for medicinal purpose. The methods of water cure, variously termed as 'hydrotherapy', 'hydrotherapy', or 'balneotherapy', employ the waters either internally or externally to maintain health or for the treatment of different diseases and disorders; and such waters are characterised by different temperatures with different organic, inorganic, and radioactive mineral constituents and gaseous phases. Hydrotherapy in Ayurveda describes the following aspects:

- (i) Order or sequence of drinking water at the time of taking meals
- (ii) Prescription or prohibition of cold water and hot water for (a) drinking, (b) bathing, (c) face-washing (**Mukha-prakshalana**); (d) gargling (**gandusham**); (e) inhalation and circulation of water through the nose, and (f) internal irrigation
- (iii) Coconut water which is demulcent, diuretic and spermatogenic is helpful for treatment of nervous disorders
- (iv) The therapeutic value of the urines of the female species of animals, comprising cow, goat, sheep, and buffalo and the male species of horse, donkey, camel, and elephant
- (v) The therapy with the urine of man (not of woman) to relieve the skin and blood defects
- (vi) Longevity of life without old-age ailments by regularly (a) drinking eight **Prasritis** of water before sunrise (**Prasriti** is a unit of volume measure for which the two palms are joined together as a cup or basin) and (b) bathing after applying the powder of **Amalakee** or **Usirika** (i.e., *Phyllanthus emblica*) to the head of the body.

Medical hydrology in Ayurveda helps medicine to rediscover an excellent but neglected form of therapy for the welfare of mankind.

## References

1. Prasad, E.A.V. 1979. **Water Quality in Bhavamisra's 'Bhava Prakasa'**, N.J. Publications, Tirupati.
2. Prasad, E.A.V. 1986. **Water Quality in Ayurveda**, Tech Rept., Dept. of Environment, New Delhi.
3. Prasad, E.A.V. 1988. 'Medical Hydrology in Ayurveda', Valedictory Address delivered on Sept 23, 1988, for the Sanskrit Day Celebration at the Kendriya Sanskrit Vidyapeetha, Tirupati (A.P.)

# THE MULTIPLE WAVE OSCILLATOR

## Brief History

In the early 1900's, many researchers were experimenting with electricity as a therapeutic agent. Hundreds of devices were built and tested, many with good results. The most famous of all the devices that came from this era was the Multiple Wave Oscillator of Georges Lakhovsky.

Lakhovsky had theorized, by 1920, that each healthy cell or tissue of the body had its own natural vibration rate. He also hypothesized that a disease condition, no matter what the "organic origin", was a condition where the natural vibration rate of the healthy tissue was somehow being disturbed. To test out his theories, he began a series of clinical trials in which he exposed various diseased conditions to a broad spectrum of low power, radio frequency emissions. The first devices he used for this he called his Radio Cellular Oscillators (RCO). Using a number of variations of the device, he demonstrated the ability to "cure" certain cancers and other conditions with as little as 20 watts of electric power. The idea behind the efficacy of this device was simple. If you offer the body a broad spectrum of frequencies, each cell and organ can find its own natural resonant frequency within that broadcast and be vibrated back to its natural state. The normalized tissues can then throw off any diseased condition. By 1931, Lakhovsky had perfected his theories and redesigned his equipment. In 1934, he was granted US Patent #1,962,565 for his "Apparatus with Circuits Oscillating Under Multiple Wavelengths." With this device, he claimed to be able to treat all disease conditions successfully. Lakhovsky built about 30 units, each one was slightly different from the others. No generic design was ever developed and no schematic of any of the working units was ever published. Lakhovsky reported on the results of these experiments in his book **The Secret of Life**. The translator for the English edition of this book, Mark Clement, also published a shorter account of this work in a book entitled **The Waves That Heal**. After his death in 1942, a combination of events which included World War II and AMA resistance caused his work to fall into obscurity.

Developments in the promising field of Radio-biology slowed down during the 1940's and 1950's. Then, in 1963, interest was revived by an article in the *Journal of Borderland Research* by Bob Beck entitled "The Russian Lakhovsky Rejuvenation Machine". In this article, Bob Beck published a hybrid design, combining ideas from Georges Lakhovsky and Nikola Tesla, resulting in a device that was not true to either. All MWO's available in the USA since 1963 have been based on these hybrid designs. While not without merit, these units deviated from Lakhovsky's ideas in significant ways. Now, 30 years later, after extensive research and development by Borderland researchers world-wide, Lakhovsky's work is finally re-emerging in its original form. All of these developments are chronicled in the BSRF publication *The Lakhovsky Multiple Wave Oscillator Handbook*.

## Current Device

Borderland Sciences Research Foundation is proud to make available for the first time, an MWO which is true in its mode of

operation to Lakhovsky's original 1931 patent. These units are being made available in limited quantities to amateur experimenters who are interested in exploring the effects of low power, wide spectrum, high frequency, electrostatic fields.

The BSRF MWO consists of a power supply, a modernized circuit to produce the wide spectrum of oscillations, a high voltage step-up transformer and two 14½" multi-ring antennas and stands. The total radio frequency output is under 20 watts. The high frequency electrostatic field between the two antennas is penetrating, yet very gentle, even to the most sensitive. In a dark room, a 1" to 2" violet-colored corona discharge is seen coming off the outside ring of both antennas. This represents an output of about 100,000 volts of radio frequency energy. There are no hard sparking discharges between the inner rings of the antennas. During operation, moderate amounts of ozone are produced. The target frequency range of the output is between 20 cycles and 20 Gigacycles. Radio, television, and telephone interference may be experienced within 25 feet during operation.

These units are hand built and in limited production. The BSRF MWO is the product of a 7 year research project and is the closest replica of Lakhovsky's device ever made available to the public. Orders are being taken now.

## Price Information:

This MWO is designed to be plugged into a grounded electrical outlet. Various special order models will also be available. These include units with rechargeable batteries and even solar battery chargers built in. Also, a true Lakhovsky style antenna system made from copper tubes will be available in the future. The basic plug-in unit is being introduced for \$1600 + \$25 shipping (in U.S.A.). Battery powered up-upgrades will be \$150 more. Units with a solar rechargeable battery system will be \$350 more. The copper tube antenna upgrade will be \$1500 extra. There will be up to a 4 week delay for special order items. All basic units come with a 1 year warranty on parts and labor and a 60 day money back guarantee. For special order units, all sales are final.

## Disclaimer and Notice:

This MWO is a wide band spark-gap radio transmitter. It is being made available to amateur experimenters who are interested in exploring the effects of low power, wide spectrum, high frequency, electrostatic fields. No medical benefits have ever been clinically documented in association with the use of this device. No medical claims are made or implied. While running, the units produce 100,000 volts @ 150 microamps of radio frequency energy. During operation, harmless but startling electric shock is possible if any of the energized elements are approached too closely. Radio, television and telephone line interference may occur within 25 feet of an operating unit. Moderate amounts of ozone are produced during operation.

*For more information, wholesale prices, or to order your MWO, please contact: Borderland Sciences Research Foundation, P.O. Box 429, Garberville, California.*

# GREAT MYSTERIES OF TIME, SPACE & PLACE!!!

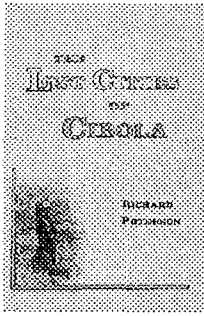

**LOST CITIES OF CIBOLA** by Richard Petersen. Residues of a prehistoric civilization in Arizona, giant stone statues on Easter Island, Ice Age deposits, mysterious falls of fish from the sky — widely diverse puzzle pieces which become facets of an amazing view into how our universe may really work. 252pp, hrbnd. #B0241 ... \$22.50

## ANCIENT MONUMENTS OF THE MISSISSIPPI VALLEY

by E.G. Squier & E.H. Davis, 1848. One of the most remarkable archeological books ever published on American prehistory! Be amazed at the incredible mound structures, elaborately designed and laid out precisely over vast areas. 376pp. #B0242 ... \$29.95

## ANCIENT AMERICA

by J.D. Baldwin, 1872. Ancient ruins dot the American continents, from mystery mounds of great antiquity to the amazing stone cities of Central and South America. Exceptionally unprejudiced view of our past! 299pp, spirals. #B0197 ... \$10.50

**THE MAMMOTH & THE FLOOD** by Sir Henry Howorth, 1887. Probes the evidence of massive flooding and upheaval in recent geological history. The ice ages simply couldn't have occurred the way we are taught. A great classic of catastrophe literature. 498pp. #B0243 ... \$19.95

**THOSE ASTOUNDING ICE AGES** by Dolph Earl Hooker, 1959. Did a great canopy of water once circle the earth? A possible explanation for the great floods of recent prehistory! Delves into the mysteries of stratification, coal formation, fossil records, physics of the ice ages. 148pp, staples. #B0154 ... \$11.95

**THE LOST PYRAMIDS OF ROCK LAKE** by Frank Joseph. Rock Lake, Wisconsin, is a lake of mystery. Divers said that there were rock pyramids on the bottom of the lake, and in this book their existence is detailed and documented against a backdrop of remnants of a sophisticated Bronze Age culture which existed millennia ago in the American Midwest. Paperback. #B0244 ... \$10.95

**THERE IS LIFE ON MARS** by The Earl Nelson, 1955. We know what we've been told, but what are the facts? With all the recent interest in Mars we have excavated this title from the BSRF archives to provide further evidence of a living universe. Canals were mapped, vegetation bands were observed growing and shrinking seasonally — REALLY! 152pp, staples. #B0245 ... \$12.95

**THE CELLULAR COSMOLOGY — *The Earth a Concave Sphere*** by Cyrus Teed (Koresh), 1922. Don't laugh! This Koresh fellow was quite well versed in optical theory, geodesy (surveying) and the like and did many large-scale physical experiments indicating that the surface of the earth curves up. Right or Wrong? It's an amazing view that will provide great intellectual stimulation and deep thought just seeing how such a diverse view can be built from physical evidence. 225pp, staples. #B0246 ... \$19.95

**BIOLOGICAL ANOMALIES: HUMANS II**, W.R. Corliss. The latest volume in the catalog of anomalies. Plenty of puzzling facts to boggle the mind and question the orthodox biological framework. 298pp, hardbound. #B0247 ... \$17.95

**Postage & Handling** - add \$2.75 / first item, plus \$1 each additional item. Double for O'seas.  
California residents add 7¼% Sales Tax. Visa/Mastercard orders call (707) 986-7211, Fax (707) 986-7272



P.O. Box 429 ★ Garberville ★ California ★ 95542

FORWARDING POSTAGE GUARANTEED  
ADDRESS CORRECTION REQUESTED

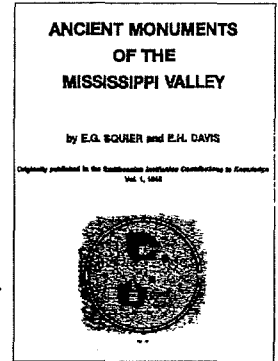

## ANCIENT MONUMENTS OF THE MISSISSIPPI VALLEY

by E.G. SQUIER and E.H. DAVIS

Originally published by the Smithsonian Institution Contributing to Knowledge  
Vol. 1, 1848



BULK RATE  
US POSTAGE  
PAID

Tarpon Springs, Fla  
Permit No. 37  
Postal Code 34689