

BORDERLANDS

THE CROSSROADS OF SCIENCE & SPIRIT

Volume XLIX, Number 2, Second Quarter 1993

<i>Chaos or Order?</i>	3
<i>Telluric Power</i>	16
<i>Grays Bite Dust</i>	17
<i>Mystery Cavern</i>	32
<i>News & Views</i>	34

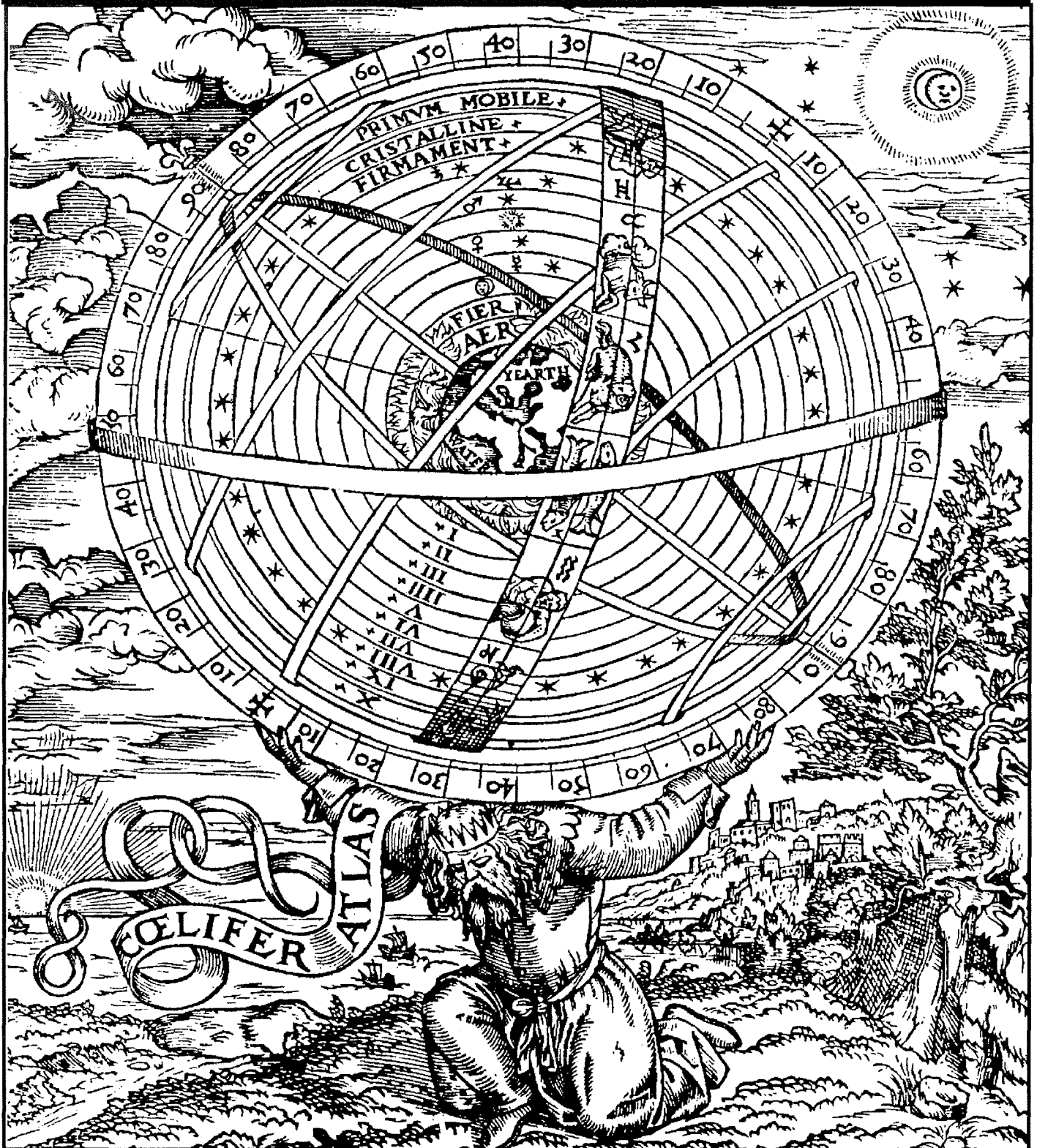

BORDERLANDS

THE CROSSROADS OF

SCIENCE & SPIRIT

Borderlands is a quarterly publication of Borderland Sciences Research Foundation, P.O. Box 429, Garberville, California, U.S.A. Phone 707-986-7211, Fax 707-986-7272. Contents © 1993 by BSRF.

Editor-in-Chief
Thomas Joseph Brown

Associate Editor & Production Assistant
Alison Davidson

Associate Editors

Peter Lindemann & Michael Theroux

Borderland Sciences Research Foundation was founded by Meade Layne in 1945 for the purpose of investigating into realms normally beyond the range of basic human perception and physical measurement. B.S.R.F. is a non-profit scientific and educational foundation directed by Thomas J. Brown. Meade Layne directed from 1945 to 1959. Riley Hansard Crabb, from 1959 to 1985.

Borderlands originated as Meade Layne's **Round Robin** in 1945 and was changed to **The Journal of Borderland Research** in 1959. It was changed to **Borderlands** in 1992. **Borderlands** is an information nexus for thinkers and doers on the frontiers of science and awareness.

Borderlands is available to members of Borderland Sciences Research Foundation. BSRF Membership fees are:

\$25/year, worldwide, Regular Membership
\$15/year, Senior Citizen Membership
\$50/year, Supporting Membership
\$100/year, Sustaining Membership
\$1000, Lifetime Membership

Membership entitles you to **Borderlands** for the duration of your membership term.

Borderlands is sent bulk mail in the U.S. and ISAL overseas. Single issue \$6.95

The main fund-raising activity of BSRF is to act as an educational clearinghouse for information, and to actively seek donations to fund our activities.

All published materials are presented for Informational and Research purposes only. Authors are solely responsible for the information and opinions they present. This material is not to be construed as expert opinion or medical advice, it is research into the **Borderlands**...

SPRING IS IN THE AIR!

Nature undertakes a perpetual renewal of Her life body, pulsating between day and night, Sun and Moon. That which remains static falls away from the dynamic thrust of the Life Force and tends towards decay. As time spirals through the quadrants of the Seasons we are shown great cosmic secrets if we but pay attention. The tendency today is to regard the Seasons as mere changes in the weather, but they are more, they define the stages of growth and decay necessary to the progression of Life. If we move with Nature we will progress, if we go against Nature we will experience the consequences. We seek to learn from Life and report herein. Enjoy!

Tom Brown, Editor-in-Chief

BORDERLANDS CONTENTS

Volume XLIX, Number 2, Second Quarter 1993

THE MYSTERY OF QIGONG

Dr. G. K. Knowlton ... 1

CHAOS, ORDER OR NATURE?

Michael Theroux ... 3

SCHAUBERGER VS. ARCHIMEDES

Albert Zock... 7

INTERACTION OF MAGNETIC FIELD AND POWER CURRENT IN SPACE POWER GENERATION

Paramahansa Tewari ... 12

FIZIX KÜRNER

Peter A. Lindemann ... 14

ELECTRO-THERAPEUTIC APPLIANCE

U.S. Patent 412,196, John S. Mellon ... 16

Paradigm de Jour

GREY ALIENS BITE THE DUST

Alison Davidson ... 17

DESIGN ECOLOGY – PART III

Michael Riversong ... 22

SCIENCE & HEALTH and THE EARTH & OURSELVES

Books by Georges Lakhovsky,

Reviewed by Jorge Resines... 24

ANOTHER POSSIBLE ALTERNATIVE TO BATTERY POWERED VEHICLES

Ed O'Brian ... 29

EXPLORATIONS IN GRAND CANYON

Mysteries of Immense Rich Cavern Being Brought to Light

Phoenix Gazette, April 5, 1909 ... 32

NEWS 'N VIEWS FROM THE BORDERLAND

The B.S.R.F. Bulletin Board ... 34

THE MYSTERY OF QIGONG

by Dr. G.K. Knowlton

The first time I witnessed Qigong (chee kung) being practiced was on cable television late one night. I was flipping with the remote when I came upon a strange sight. A man was seated in a wheelchair. The announcer stated that he had been paralyzed for over fifteen years from a stroke. An Oriental gentleman came up to the wheelchair and began to run his hands over the man. For a few moments, nothing happened. Then the patient's arms began to move slowly like a kind of giant puppet. The Qigong master moved down to the legs and in a while they began to move. When the treatment was over the man had regained the complete use of one arm, most of the use of the other and was able to slightly move his legs. The announcer then stated that the news team had its own doctors conduct a battery of tests on this man and he was indeed paralyzed and when they examined him later, he did appear to have made a partial recovery.

As a practicing physician and acupuncturist, I was stunned. I had heard about Qigong but was told it was too esoteric and was not for the western mind. This program convinced me that this Oriental technique was something I had to learn.

Qigong is the oldest healing technique known to man. It is the father of acupuncture and predates acupuncture by several thousand years. Qigong deals with the regulation of the life force of the body called Chi or Qi. It is a form of human energy or bioelectricity generated within the body and also produced when you eat. Gong refers to ability or technique to regulate this energy in the body.

Qi is divided into internal (neiqi) and external (waiqi). Everybody has neiqi but very few ever take the time to properly utilize it. The neiqi can be developed to such an extent that one can develop the Iron Shirt or Golden Bell Covering which will make the body able to withstand strikes and blows. Some have developed their neiqi to such an extent that a knife will not penetrate the skin. Such powers were common in China in the days of hand to hand combat, but fell into disuse with the invention of gunpowder.

The emission of waiqi or empty force technique is the heart of Qigong therapy. This technique is accomplished by using the

About the Author

Dr. G.K. Knowlton, 5555 E. 71st Street, Suite 6100, Tulsa, Oklahoma, 74136 is a practicing chiropractic physician and acupuncturist. He has a complete Qigong course for sale which includes a manual and video. If you wish more information, please contact him.

mind, breathing, movement, special herbal ointments along with special herbal elixirs.

SCIENTIFIC STUDIES

Because of the myth and mystery surrounding Qigong, the Chinese started to study it in 1960. Medical researchers in Shanghai found that a Qigong master could slow down his own heart rate along with respiration rate, in some cases falling to 70% of normal level. In 1977 in Beijing, it was found that a master can actually emit a certain type of energy that could be measured. There have even been studies in America that confirm this.

Even today the research continues at the General Hospital of the Navy in Beijing, home of the Institute of Immunology. Much of the research there involves cancer. Cancer cells are isolated and subjected to waiqi emissions and then compared to a control group. The same is done with lab animals injected with cancer cells. After two weeks of Qigong treatment, large tumors in rats had shrunk. After they stopped the waiqi the tumors started growing again, so the treatment was continued for five more weeks and the tumors disappeared. The institute now plans human studies.

Some schools in China offer Qigong classes for eyesight to their pupils who have trouble in reading or seeing the blackboard. The improvement rate is very high and many do not need glasses.

The most famous case history in China is that of Li Juan a famous television anchorperson. She practiced certain Qigong exercises which were deep breathing for only fifteen minutes twice a day. Millions saw her lose more than twenty pounds by this method. I am not sure but I think she practiced a Daoist method called "The Swimming Dragon," which if done correctly, is a very simple method of weight loss.

METHOD REVEALED

After much searching, I began the techniques of Qigong and projection chi. I found out that it is not so much that they are secret, but it is that so few Westerners have bothered to learn it. I began practice and soon was able to perform projection chi. This was verified by several reporters from the Tulsa World newspaper and lead to a subsequent story.

In this article, I will give you basic, beginning Qigong instruction. This will involve the flow of chi to your hands. I have practiced this method and have become so skilled that I can stand outside on a cold winter day without gloves and while performing this Qigong, my hands will become hot to the touch and will actually sweat.

This Qigong comes in two parts, the breathing and the moving meditation. All a moving meditation does is to allow you to direct chi by the slow movement of the body. It is a forerunner of Tai Chi. As a matter of fact, I call this the Qigong or Tai Chi ball technique.

DON'TS

If you are going to be successful in Qigong, there are several rules you should follow and also things to avoid. If you continue

to do the things you should avoid, you will never achieve mastery no matter how long and hard you practice.

1. **DRUGS:** Avoid all but doctor prescribed medications. Drugs distort and in some cases, destroy chi. Stop smoking as you will not be able to do the deep breathing. Avoid alcohol as it affects the central nervous system. Also cut out caffeine. I used to drink a cup of coffee before my workouts. I found that I could not collect and send chi until the caffeine had left my system, usually 24-36 hours later.

2. **SLEEP:** You must get the right amount of sleep. Neither too little or too much. You will find that regular Qigong practice will reduce your need for sleep.

3. **EMOTIONS:** You must try to control your emotions as worry and anger inhibit concentration, blocking chi flow.

4. **IRREGULAR PRACTICE:** If you are not going to practice this regularly, don't expect any results. Each day adds to the one before it until the chi flow will come quickly and upon command.

BREATHING

Breathing is the basis of Qigong. There are two main breathing techniques and you will be taught the most important which is Abdominal Breathing. Most of us in western civilization have been taught to breathe from the chest. The Chinese have long known that power comes from the abdomen. Chi is generated through abdominal breathing.

Stand erect with your hands at your sides. Breathe in deeply through the nose and as you do the abdomen should extend. Breathe out through the mouth and pull in belly. You may also exhale through nose.

Practice until it becomes automatic.

PRACTICE TIMES

The ideal time to practice is 6:00 AM. If this is not possible, use these other times: 11PM to 1AM; 3AM to 5AM; 7AM to 9AM; 11AM to 1PM; 3PM to 5PM; 7PM to 9PM.

According to Chinese theory practice at times other than these is worthless.

TONGUE POSITION

The tongue should be touching the roof of the mouth. Anywhere from just behind the teeth to as far back as you can put it. You will know when you have touched the right area as it is like touching your tongue to a battery, you will feel a mild electrical charge. Holding your tongue in this position while practicing will help to open the various energy pathways of the body.

THE TECHNIQUE

Stand comfortably as shown Figure 1 with your right hand in your left, thumbs touching. Take three deep abdominal breaths (all breathing in this technique should be abdominal) and then just relax for 5 minutes. You do not need to time this, just relax for what seems an appropriate time for you. When you are ready, take three deep breaths, lower your hands to your

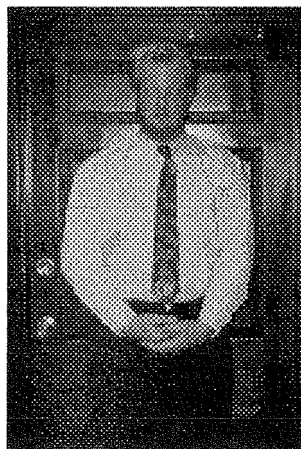

Figure 1

offers resistance to the act of bringing hands close together and then pulling them apart. For example, when you spread your hands, imagine them being stuck together with glue and the farther apart you pull them, the harder the action becomes. When you bring your hands close together, it is like trying to bring the same poles of a magnet together and the closer you get, the harder it gets. Opening movement never

sides and begin. You may begin practice with your eyes open, but as you learn it, keep eyes closed.

Start by slowly raising and lowering your hands to shoulder level as shown in Figure Two. Repeat twice.

Assume position in Figure Three. It looks like you are trying to catch a basketball. The most important part is mental activity. Imagine a powerful force field between your hands that



Figure 2

needs to be more than having the hands a foot apart. Bring them as close together as you can without touching.

After a short while you will start to feel the resistance and it will grow as you continue to repeat. Your movements will no longer be slow and controlled but a series of halts and jerky spasmodic movements as the chi starts to flow.



Figure 3

When you have achieved a strong chi sensation, put your palms down slowly and place them on your lower abdomen (Figure 4) until you feel the chi subside.

This technique may also be done sitting or lying.

This is only one of many Qigong techniques. I hope you enjoy it.

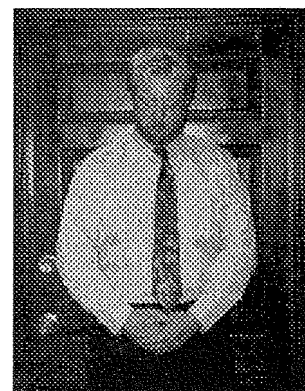
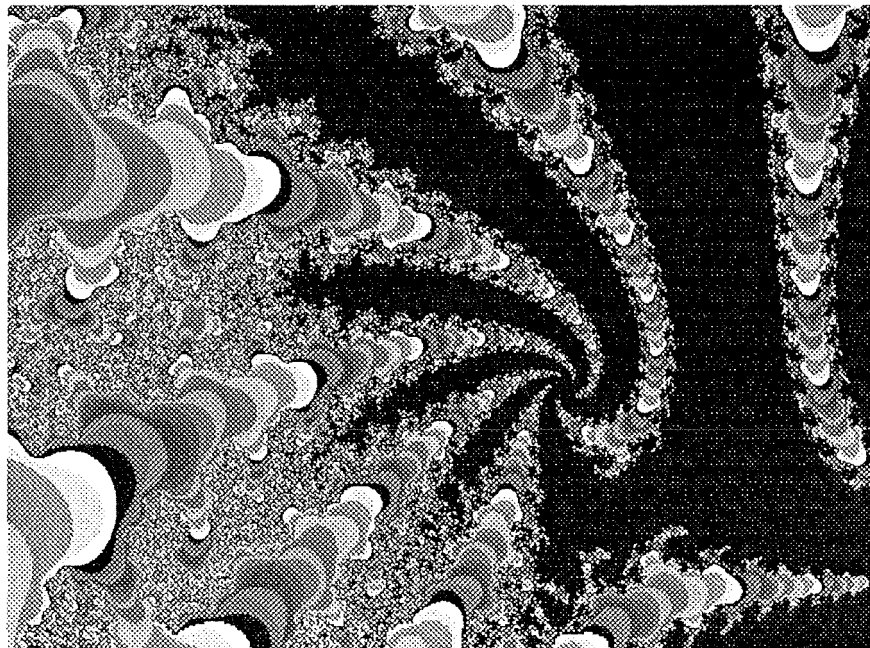

Figure 4

CHAOS, ORDER, OR *Nature?*

by Michael Theroux



A new fractal at high magnification demonstrates the natural tendencies of Golden Section geometry and displays the characteristics of Reich's theory of Cosmic Superimposition.

It is indeed a rare thing that we should not only witness her beauty, but wholly embrace the visage of that divinity we baptize as nature. As the naturalists sought out the qualitative in life, so the fundamentalists of science tried ever to define nature's character in quantitative analysis. Herein lies the elementary problem concerning chaos theory. For a time, I found myself disregarding chaos theory altogether, owing to the fact that I regarded myself as one whose mission was to sustain that which could be rendered "life-giving," and to slight all that was not. Finally, it was time to investigate what all this nonsense was about. Of course, within this investigation, I would adhere to my subjective intuitions.

The idea of chaos theory is that a seemingly random (chaotic) function displays periods of order, and that these periods will be self similar; that is, in perfect relation to one another (without delving too far into the history of this so-called "chaos" I will explain some of the high points in its association). A fine example is known as the Bifurcation which is an illustration of population growth and has been studied by many biologists. Consider a time line, insert the right formula, and geometrically you have a representation which exhibits stable and unstable regions of growth. The interesting fact is that the stable regions appear in a perfectly ordered fashion, contrary to what is expected. Again, the problem with the theory is that one may think that order has been created out of something appearing to be chaotic, but in reality there is nothing but an already ordered system which has subtly revealed itself. A contradiction. Alas, this is the way with nature – or is it?

It was Benoit Mandelbrot who came up with the term "fractal" and it is his efforts that have brought the whole science of chaos into the spotlight. His paper entitled, "How Long is the Coast of Britain" opened up a new avenue of thinking in the mathematical and theoretical sciences. This idea of just how to measure the coastline would naturally depend upon your view-

point. But, Euclidean measure could do no justice to the demarcation of irregular shapes and this is where one must turn to the perception of dimension. Many were quite familiar with this concept including such early pioneers as Charles Proteus Steinmetz who expounded on the nature of space in relation to projective geometry and the theory of relativity. If dimension altogether relies on your point of view, from what distance does one measure an object? Advancing from the macroscopic to the microscopic levels of perspective, one will begin to perceive certain definable details, and although reminiscent of the whole, display a quality of irregularity and immeasurability. An infinitude in either case, if you will. Through his studies of irregular patterns in natural processes, Mandelbrot came upon the quality of self-similarity. This new geometry was to be hailed as nature's own.

Anyone who has seen a fractal has seen the now famous Mandelbrot set. The formula for its creation is quite simple; take a number, square it, and add the original number ($z^2 + c$). The process is then repeated indefinitely with the iteration being either rational or irrational. Those that are rational become a part of the "set" and those that are not, do not. With the magnification of the set, the self-similarity reveals itself by displaying a replica of the original. It is an extremely complex and beautiful form developed out of a very simple formula.

But what about a fractal's relationship to nature (or using the new science term "dynamical system")? The difference is that when nature forms something it follows a general rule called the Golden Section. Some have tried to define this "irrational" number as just that – a number. More correctly it is a ratio, not an endless number string. Pi, Phi (the Golden Mean), the squaring of a circle, and other mathematical conundrums of so called irrationality have kept the quantitative theorists methodically labouring for centuries with no answers in sight (but probably keeping them employed). Phi, as an irrational number,

may be familiar to most in the form of 1.6180339...etc. The more appropriate geometric representation is: $\sqrt{5 + 1}/2$. This function shows itself repeatedly in all of nature and has thus been deemed an intrinsic component of what has been referred to as "Sacred Geometry". From the phyllotaxis of plants (their spiralling arrangement of leaves) to the Nautilus shell, the Golden Section or sacred geometry is found throughout all *growth* in nature, and has been dutifully emulated by both ancient and modern artist in sculpture, architecture, and music.

In order for the fractal idea to model nature's processes I felt it necessary to insert the Golden Section into the established formulas for experimentation. In the initial stage of the experiment I added the $\sqrt{5 + 1}/2$ and $\sqrt{5 - 1}/2$ to the extant $z^2 + c$ formula (where c actually became the Golden Section) and was not completely surprised to see the patterns of growth exhibited by the Nautilus shell emerge. Most showed the characteristic self-similarity described by the modern chaos theorists. Continued manipulation of the formula (z^3 and z^4) produced the resemblance of the reproductive organs of both female and male respectively. Here, in deep magnification, the issuance of spiralling forms would reveal a striking similarity to the vortexian

mechanics of flowing water and galactic streaming so important to the theory of cosmic superimposition. But, what I found most fascinating was that upon extreme magnification, these implosive tendrils of form experienced periods of orbital irregularity. At once these spiralling shoots would appear to be gravitating toward a common center but then in certain instances would sprout new shoots not following the typical orbital pattern, as though they had found a new source of entrainment. Through successive manipulations of the basic formula using the Golden Section, I arrived at a form appearing to have no self-similarity up to the highest magnification possible. It is the imperfection of this "coastline" form which reveals a part of the genuine beauty of nature. This would naturally be true chaos, if indeed it is correct. What is interesting in the most qualitative and subjective aspect of nature – is that there is a seeming chaos in which her processes work. For instance, a typical IFS (Iterated Function System) fractal – one that utilises self-similarity to create objects somewhat *resembling* plant life – in its generation, is perfectly formed. However, in nature, the formation of plant life most often produces anomalies in character which do not typically follow the self-similarity code. The same error proves true for what are

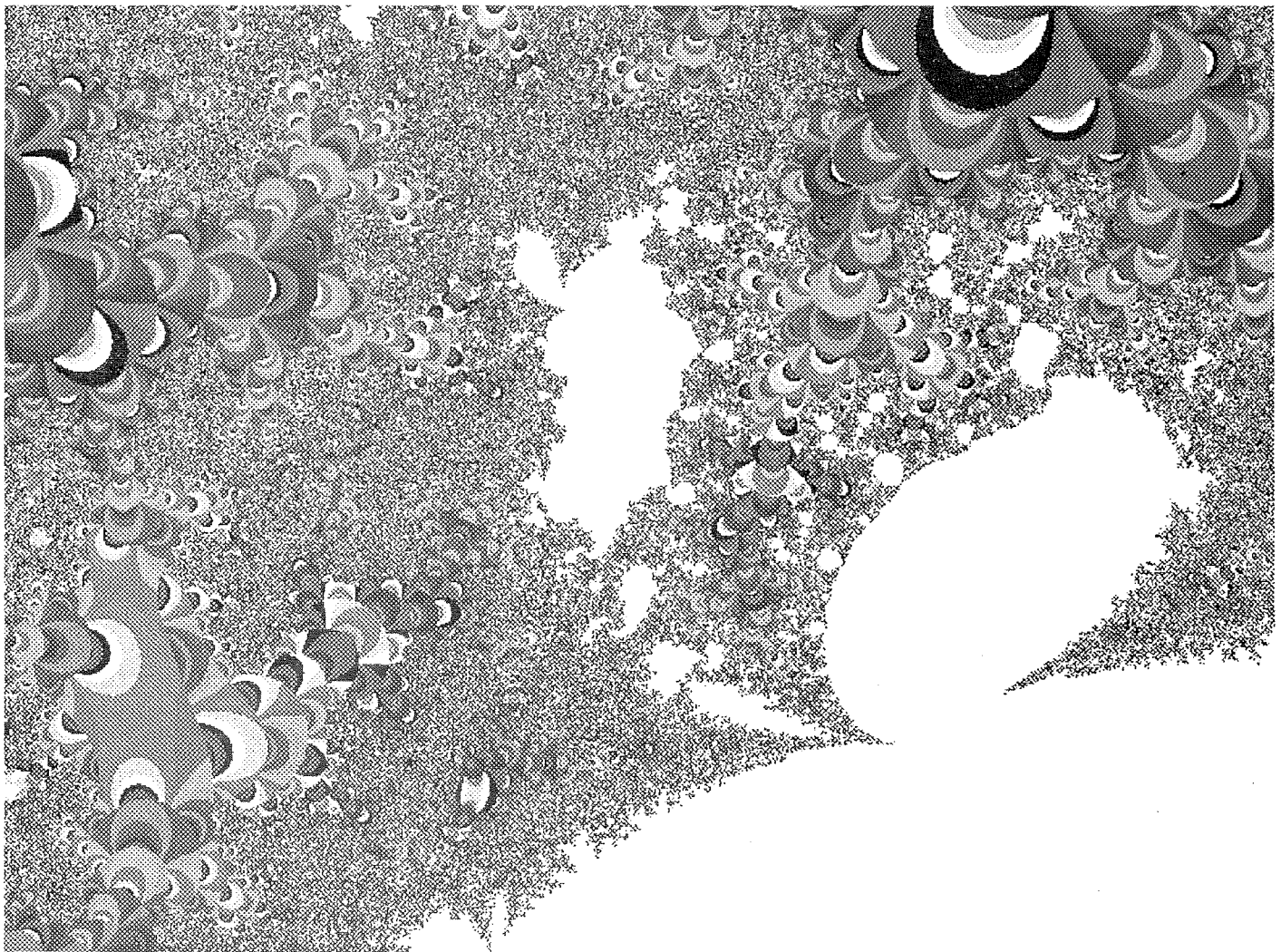

This 'coastline' example using the 'test 3' formula at high magnification displays virtually no self-similarity

known as L-Systems fractals. These were developed in 1968 as a method for modeling the growth of living organisms. The mathematical processes involved with these fractals mechanically instruct the computer how to generate the image and really have no relation to the growth of anything living or dead. Only by the inclusion of Golden Section geometry into the formulas are we to gain anything *resembling* the structure of nature, and dimensionally, these images are still quite lifeless. Only the motive properties of projective geometry will produce the growth factor into Golden Section geometries and this brings about the limitations inherent in computer generated iconography. This does not mean that something cannot be gleaned from researching the fundamentals of form through the use of computer generated images. The intricacies of these Golden Section images are in themselves a portal through which we may understand Nature's dynamical systems more closely, but we must remember *it is certainly not the complete picture*. That the orthodoxy of science would represent nature with such mechanistic examples like the L-Systems and IFS models, is typical of their wanton destruction of the living. Nowhere can we define nature with such absurdities, and nowhere are we to "order" chaos. Nature has defined for herself what is to be order and what is to be chaos. The two are inseparable yet distinctly separate entities.

I feel that the idea of the so-called "chaos" theory is of great importance in understanding certain basic

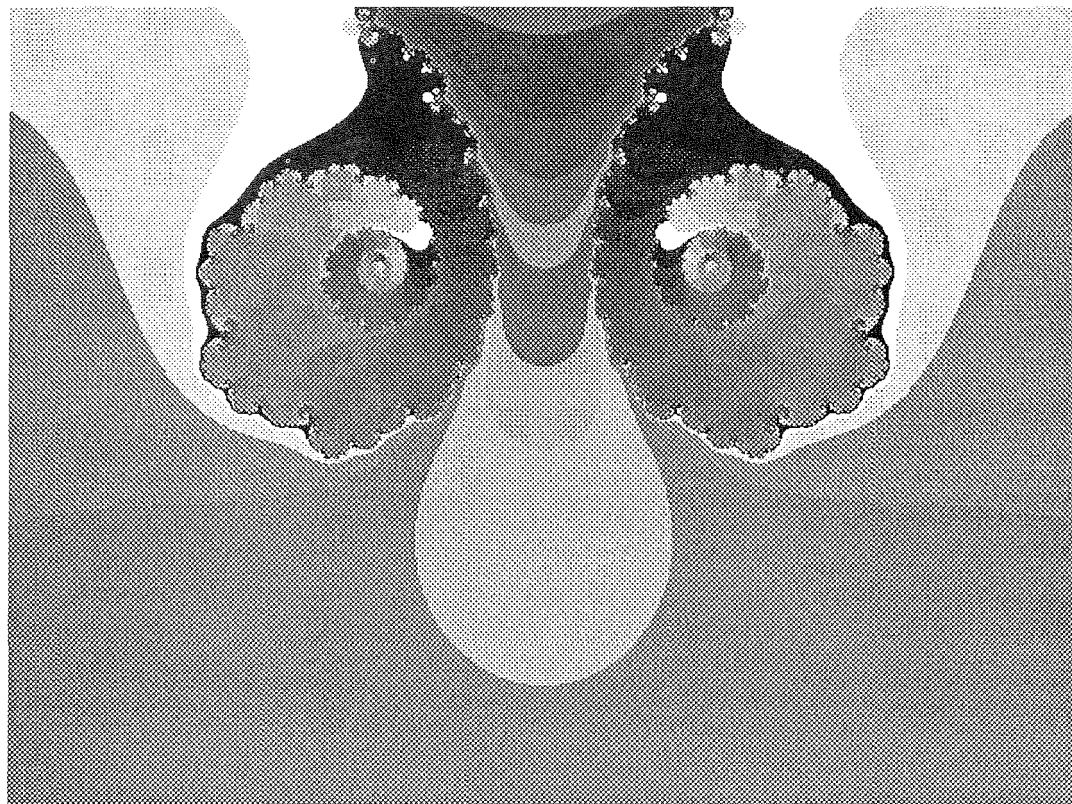

Example of a Lingam using the 'Element' formula

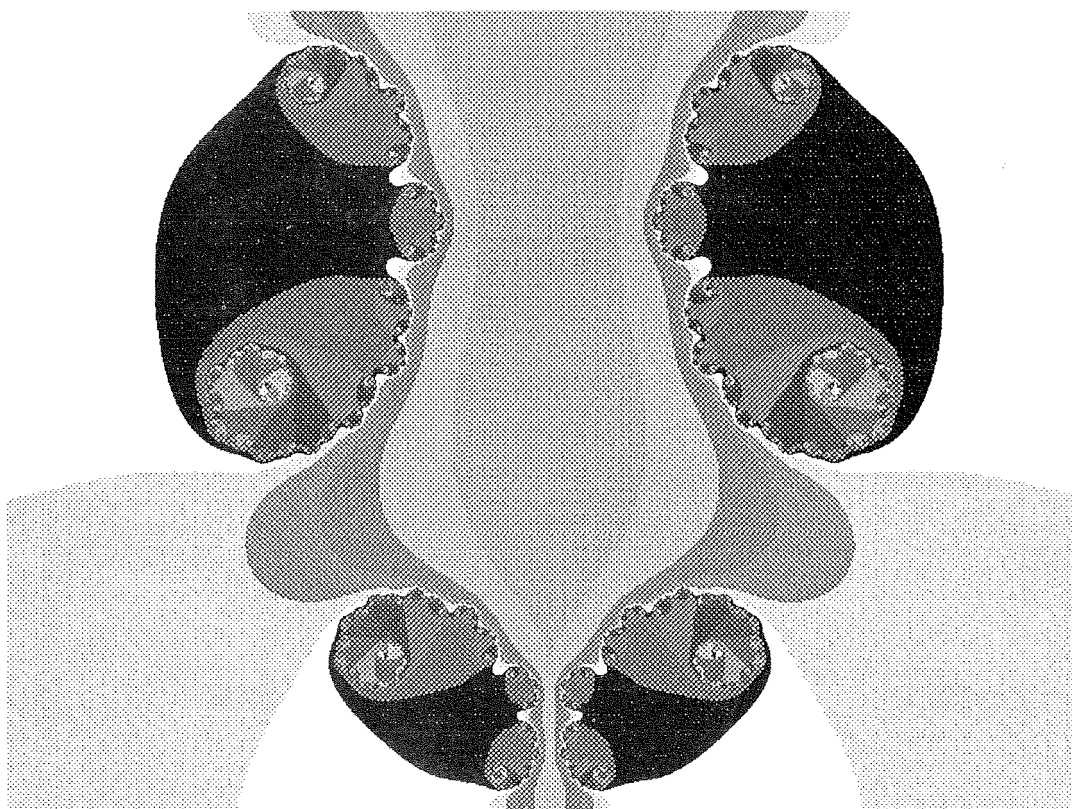

Example of a Yoni using the 'Natura' formula

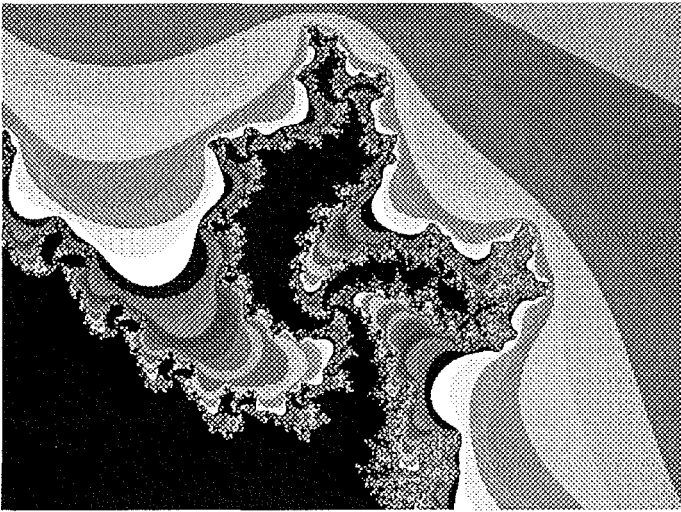

This example revealed itself by using the 'DrChaosbrot1' formula

functions of mathematical concepts such as self-similarity, but more importantly we should be concerned with the non-Euclidean geometries associated with spatial perspective and growth in the living. The inappropriate expression "chaos" would seem to be another avoidance of Nature by those bound solely to quantitative analysis, but this should not limit those with a desire to understand quality as well as quantity in all "dynamical systems". That nature works on defined geometric principles is undeniable. It is therefore undeniable that Nature's geometry be included in what people are erroneously referring to as "chaos".

REFERENCES

1. **Chaos -- Making A New Science** by James Gleick 1987, Penguin Books.
2. **Fractal Creations** by Timothy Wegner and Mark Peterson 1991, The Waite Group Press.
3. **Fractint 17.2** Freeware program for generating fractals, available from Murphy's Law CIN, 707-923-4897.
4. *The Golden Section* by C. Fredrick Rosenblum, **Journal of Orgonomy**, Vol. 8, No. 2.
5. **Cosmic Superimposition** by Wilhelm Reich, o.p.
6. **Four Lectures on Relativity and Space** by Charles Proteus Steinmetz, 1989 reprint, Borderland Sciences.
7. *3.1415927...etc., etc., etc.* by Michael Theroux, **Journal of Borderland Research**, May-June 1987

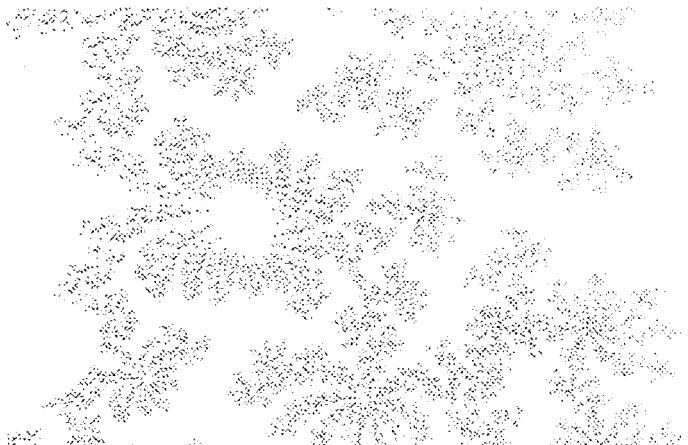

NEW FORMULAS

;Please note that the file below is set up to run with Fractint 17.2 and needs no modification.

;All of these formulas are based on the Golden Section or Phi as it is found everywhere in nature. Exhibiting true patterns of growth, these are new to the genre and have many interesting characteristics not found in the "secular" world of fractals. All of these fractal formulas work with Fractint 17.2. Enjoy.

Michaelbrot(origin) { ;based on Golden Mean

```
z = pixel:
z = sqrt(z) + ((sqrt 5 + 1)/2),
|z| <= 4;
}
```

Raphaelbrot(xyaxis) { ;phi

```
z = pixel:
z = sqrt(z) + ((sqrt 5 - 1)/2)
|z| <= 4;
}
```

DrChaosbrot1(xaxis) { ;more phi

```
z = c = pixel:
z = sqrt(z) + (((sqrt 5 + 1)/2)+c)
|z| <= 4;
}
```

DrChaosbrot2(xyaxis) { ;more phi

```
z = c = pixel:
z = sqrt(z) + (((sqrt 5 + 1)/2)+c)
|z| <= 4;
}
```

Natura(xyaxis) { ;phi yoni

```
z = pixel:
z = z*z*z + ((sqrt 5 + 1)/2)
|z| <= 4;
}
```

Element(xyaxis) { ;phi lingam

```
z = pixel:
z = z*z*z*z + ((sqrt 5 + 1)/2)
|z| <= 4;
}
```

;try inside=maxiter and outside=imag on these

```
test(xyaxis) { ;+phi
z = ((sqrt 5 + 1)/2)/pixel:
z = z*z + pixel*((sqrt 5 + 1)/2)
|z| <= 4;
}
```

```
test1(xyaxis) { ;+phi
c = pixel
z = ((sqrt 5 + 1)/2):
z = z*z + pixel*((sqrt 5 + 1)/2) + c
|z| <= 4;
}
```

```
test2(xyaxis) { ;+phi
z = ((sqrt 5 + 1)/2)/pixel:
z = z*z*z + pixel*((sqrt 5 + 1)/2)
|z| <= 4;
}
```

```
test3(xyaxis) { ;+phi
z = ((sqrt 5 + 1)/2)/pixel:
z = z*z + pixel*((sqrt 5 + 1)/2)/((sqrt 5 - 1)/2)
|z| <= 4;
}
```

Tetratraphi(xyaxis) { ;?

```
z = c = pixel:
z = c^z + ((sqrt 5 + 1)/2)
|z| <= 4; }
```

SCHAUBERGER

by Albert Zock

VS

*“Newton should have asked,
how the apple came to be on the tree
and not why it fell down!”*

ARCHIMEDES

In history nothing is new, it only repeats itself in different ways. In Cheops' time, droughts were as common as today. However, he did something about it, but we do not, soon we too must do what he did — make rain. To understand his and our situation, some explanation is in order. Newton and Archimedes only re-discovered what the Egyptians knew long before them. As for Archimedes (280 to 212 B.C.) we must amend his equation; “If an object is heavier than water, it will sink, but if it is less heavy it will float,” into; “If a surrounding medium is equally dense as the surrounded, there is no gravitation nor levitation, but if the surrounding medium is denser, then the surrounded must rise.” And “Newton should have asked, how the apple came to be on the tree and not why it fell down!” (Victor Schauberger)

It is an old phenomenon that in hot summers, farms in valleys run out of water, but wells high on mountains are still filled! Should it not be the other way around? According to Victor Schauberger; “The dense and cool collects on the bottom, above floats the warm, and the hot is always on top!” Fill some identical containers with water, add a different colour to each and warm up to different degrees, then empty all into a transparent cylindrical one and watch how the colors adjust themselves according to their temperature. Water at 4° Celsius is dense and heavy and will sink to the bottom. When water temperature reaches its freezing point at zero degrees Celsius, a paradox emerges, from now it will coagulate to ice, but at the same time expand, and because now it has less cohesion than the cool and dense water surrounding it, it must rise, that is what makes ice float! (see Fig. 1)

WHY ARE SPRINGS ON MOUNTAINS ALWAYS COOL?

The presumption that Earth pressure forces water up and creates springs, proved to be wrong. Bio-technicians know that

springs and ground water play a role within forests, but what creates them? During a vegetation period, a one hectare (just 2 acres) deciduous forest evaporates 50,000 litres (quarts) of water per day. In spite of that, a forest is still the greatest water reservoir. Each evaporation has a cooling effect. We can experience such cooling effect after a dip into a pool, lake or ocean, as the droplets on the skin evaporate in the sun. An evaporation on top of a leaf, produces a cooling of the sap beneath, it becomes heavy and sinks through the branches and stem back into the roots, creating a cool zone there as well and forces warm sap upward. The cool zone has two functions, first it prevents warm surface water from trickling into the ground, as it is impossible for warm water to pass

down through a cooler layer. Here we observe the wisdom of creation and the reason why forests are always damp and its roots have the needed water. The same principles apply to orchards. If beneath the cool roots some additional warm water happens to be, it must rise and pass through the cooler layer to position itself on top, no matter if it is 100 or 1,000 yards below, and by very high temperature, the rise through

Figure 1

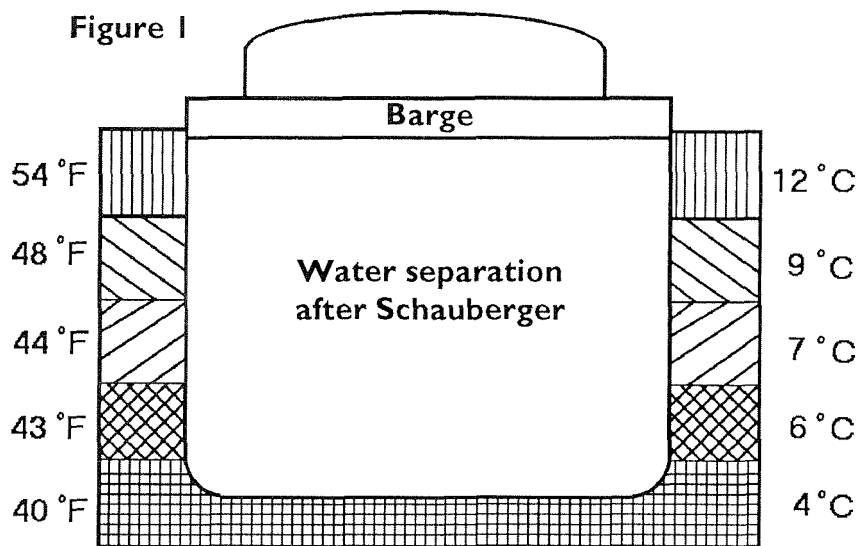

the cool layer can be so strong that it creates a Hot Spring!

In deserts, because of lack of trees, the ground water sinks deep and waits for a Bio-technician to be lifted up and transform the desert into a paradise as it was before. Another reason why water will gush out on top of mountains is air temperature between ground and top. The higher we go, the cooler the air. Here we find the diversity between Technique and Bio-technique. The first uses powerful pumping stations driven with costly energy from oil, gas or coal to lift water, the other works with minor temperature differences yielding multiple attainments without pollution! Further reason for springs on mountains are temperature differences along the slopes, as with each foot

upward the temperature drops, and if slopes are covered with trees and bushes, the blessing is twofold! But cut the trees and expose the spring to the sun - it will stop springing!

In my late teens, I worked as a deck hand on a riverbarge in Europe. Such vessels had no propulsion of their own, they had to be towed up the rivers and only on their voyage back would flow with the stream. They took so much cargo that their flat bottoms cleared only 5 inches above the most shallow point in the river. I was always amazed how a barge could move about 3 miles per hour faster than its surrounding water, which gave the badly needed steering power, and nobody could explain why? Now I know why. The warm water on top drags its feet, so to speak, as it follows Archimedes law, but the cool and dense on the bottom runs faster, pushing against the lower part of the barge, as if it tries to push it out of its way! (Fig . 1)

To find some proof that there is an invisible connection, an axis, between the stream and its source, Victor Schauberger undertook an experiment. Close to the source, some of his workers started to warm up big kettles with water. A good distance down, Victor and others found and observed a school of trout standing in the stream. As soon as those above started to pour the hot water into the creek, the trout got nervous, started to totter, soon lost balance and floating on their sides, got washed away by the stream, long before any of the warm water had reached this place, proving that some invisible connection had been temporarily interrupted. The same happens when river water is used to cool atomic reactors!

long distances, they conversed via smoke signals from one mountain to another, cutting the wood for it right next to the springs, as it was most convenient, which in time exposed the springs to full sunshine. Traces of former springs are still there, carved into the rocks as silent reminder and warning of the consequences, yet, modern man is no smarter, as he is not aware of the subtle changes around him, but outsiders are!

In 1958 Victor Schauberger with his son Walter, a Dip. Engineer, visited the U.S. spending three months in Texas. Walter also toured New Mexico, Colorado, Arkansas and Oklahoma. In Sherman, Texas, Walter had a conversation with an 82 year old who told him about a great forest, where then just a few pitiful trees stood. The ground had no humus and was burned by the sun. "Tell me Mr. Dodden, how was it here, when you were a boy?" Walter asked. "Yes," said Mr. Dodden; "only 70 years back, here, where we stand now, stood a beautiful Oak Forest, and there on the river, where everything is bare now, grew over three feet high grass, and myself have seen many buffalo, you only could see a little of their backs."

"What happened that everything is so bare and burned?" Walter wanted to know. "Well, we cut the trees to make money, but then things changed very suddenly," said Mr. Dodden. Later Walter spoke with Dodden's son, who was 55 years old. He could remember many things, but not the forest, just that the grass was greener than now. "But if that continues, what then?" Walter asked. He said; "America is big, and what we have now in Texas is enough, besides we drill for oil, and

when we find some we make money again." Walter also talked with the grandson, who thought Texas was beautiful and could not imagine how a forest could have been there.

In the above example, one can see how fast a landscape can change. It is painful that where seventy years prior to 1958, thousands of buffalo in high grass roamed, seven decades late one was asked if there was enough water in the radiator, as for the next hundred miles or more there was not one drop available. Walter pondered the question, how could such a sparsely populated region have such great destruction, and it came to him. The buffalo had something to do with it. Buffalo feed on grass and their droppings fertilize the pasture, and when the buffalo disappeared, nature's process was disrupted and the landscape started to die. Trees are like pumps, their huge vegetation creates a vacuum in the roots, that lifts underground water and holds it up. Cutting trees stops this "Hand in Glove" work of nature. As the vacuum disappears, the ground water level falls and the deeper it sinks, the drier the topsoil will be, as the subtle evaporation in the depth is too weak to reach the surface. However, there is a cure for that — RAIN!

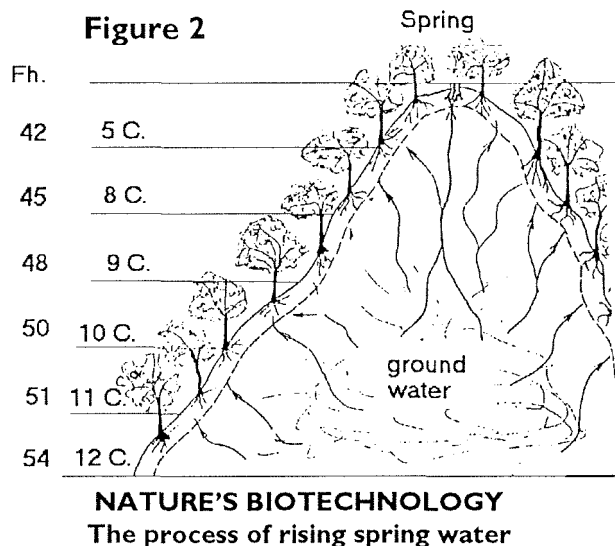

OLD AND NEW DESTRUCTION OF NATURE

It is a common belief, that industrialization is responsible for all environmental problems, and that going back to horse and carriage would eliminate all this, as coal and oil would not be needed. Ironically, it was in time of horse and carriage when most destruction of nature took place. On the contrary, the use of coal and oil has been a blessing in disguise, as progress cannot be stopped and without coal and oil, the abuse of trees would have been worse, as cutting trees without reforestation is the main reason for droughts and famine in the Third World today, as the "Mighty Cedars of Lebanon" are no more. The ancient forests around the Mediterranean gave moisture and coolness which sustained an exuberant growth of vegetation deep into the land, with three harvests a year, until the rulers grew bold and vain. Their male chauvinistic war games, and later Rome's quest for World Supremacy needed wood for smelters and war ships. When wood was gone, they used manure as fuel, depriving the soil of the badly needed fertilizer. In America, before the white man came, the ancestors of the Incas in the south and the Pueblo Indians in the north did this job. Because of high mountains and

"NO OTHER PROCESS IN NATURE IS AS EASY TO IMITATE AS RAIN"
Hermann Waldhauser

In hot deserts or dry belts, the Earth's surface is completely dried out, as the emanating heat repels low clouds. In such regions to cause rain to fall, there is only one way to do it - from the ground up, not from the sky down, as there are no clouds to start with. A large quantity of water must be quickly transpired and it must be immense, that the following condensation leads to rain. To accomplish this, large and hot surfaces are needed. Apparently in the past, such principles were very well known, as scattered over the Globe we find remnants indicating that rain-making was an old art, may it be the tower of Babylon, the stone cones in Africa, the stone figures on Easter Island or the Pyramids in Egypt, Mexico and Asia. Even fire has been used to induce rainfall, by burning fruit or cactus fields. The stone figures on Easter Island point to the same. Underground caves indicate storing of water, an open duct, about 2 miles long, 27 feet wide and 13 feet deep, referred to as "The Fire Oven of The Long Horns." In ancient times big fires burned in this duct, heating up not only the stones but the long ear figures as well. When the heat was at its peak, water was rushed into it, creating a gigantic steam and dust cloud which shot miles high into the sky! Observation on stone Pyramids showed a remarkable upward draft of air on all four sides. Suction on the south side at noon is so strong, that scraps of paper shoot up along the surface, higher than the Pyramid. Because of the alignment to true North, and their inclination, one after the other of the East, South and West sides, will face the sun direct and maintain an even upward heat flow during the day, converting sunlight into flowing energy!

The rising hot air creates a vacuum at the base, which attracts cool and moist air, if a Pyramid is surrounded by water. On the upper end above the apex, the strong moist and hot draft will clash with the cooler and slower one from the North side which lays always in the shade. This lower temperature and speed difference creates a strong helix that shoots up into the sky, and later instills condensation, and if there is enough moisture, triggers rainfall. Naturally, any similar geometric form will bring a similar outcome, may it be a cone or step Pyramid. (see Fig 3 and 4)

The underground canal to the Great Pyramid is not a mistake but reality, and the water came not from the Nile below at this point, but from a diverted, man made canal overhead on the Libya side, and will be explained later.

Naturally, in dry regions, a pyramid just surrounded by water is not enough, additional water must be poured over its sides. But

how to get it up there? The best way to do it, would be from the inside out, and the ancient builders solved this problem beautifully! The main clue lies in the word "Pyramid", it is a Greek word, probably coined by Herodotus himself, a Greek historian, who visited the Pyramids about 450 years B.C. PYR means FIRE and AMID stands for within. FIRE WITHIN, these two words will solve this riddle!

To this writer's knowledge, only three men found the answer, the British historian Perring in 1837, Edward Kunkel, a hydraulic engineer of Warren, Ohio, in 1932, and the Master craftsman Henmann Waldhauser of Steyr, in Austria, in 1976. Kunkel and Waldhauser even constructed a working prototype each, proving that their hunch was right.

Both men studied Herodotus' reports, and both went to Giza, to search on the spot for traces to verify their theory, but Kunkel went further and made it official, as today, CHEOPS HYDRAULIC PUMP bears U. S. Patent # 2, 887, 956! How he did it? In 1932 Kunkel attended a lecture by a club member, who just came back from Egypt. Next day his friend made a remark; "I bet one could make 50 bucks with an article disproving some of the silly ideas these theorists try to ram down our throats." It was depression time and for Kunkel 50 bucks meant a lot.

The speaker had also mentioned huge obelisks, and especially the 80 ton heavy temple door at Karnak, suspended only by two pivots about the size of bowling balls. How to erect heavy monoliths without leaving the ground was easy, but a door must be picked up and set down. How did they get it off the floor, as such a job has limited possibilities? Edward came up with seven ways, however, and after

using elimination there was only one way left, which was by means of pumps and hydraulic water power. First the door had to be lifted to stand-up position, then around the spot he would build a stone walled enclosure. Further, a two feet wide hole had to be cut in the upper third center and a wooden shaft to fit the hole had to be made. Then, on each side of the door a barge had to be built with a support in its center, for the wooden shaft to rest on. Finally, the enclosure would be filled with water. As the barges start to float, the door will hang itself straight by its weight and can easily be moved over the socket, now let the water level slowly drop and the door will set itself on the pivots. Remove shaft and barges, and the job is done! (see Fig. 5) What a concept, erect the door first, then build the temple around it! The same technique was used to build Pyramids.

The only thing left to do is to fill the hole in the door and cover

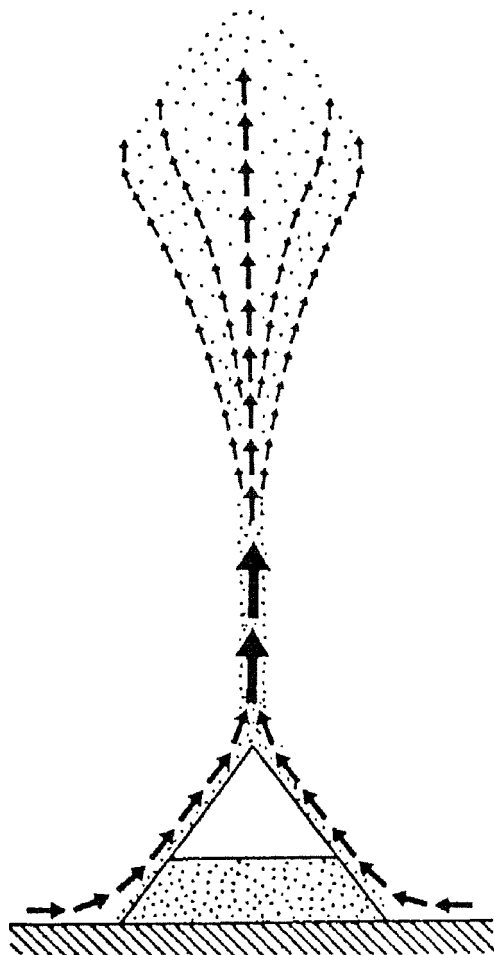

Figure 3

the spot on both sides with a round ornamental stone plate, which you will find on many temple doors, proving it was done that way, but not only the doors, the temple walls and enclosure have hydraulic designs, as Kunkel discovered when he visited Karnak years later. The walls are high enough to erect any monolith within it, and can resist high water pressure. Further, on top of each course of building blocks, are narrow slot-like bevel cuttings, indicating that tools to set the stones were used inside, and the purpose of the narrow cuttings was to be able to pull the brackets out after the stone was set. Such a method had no need for cranes,

tackles, levers, scaffold or other riggings, and no need for brute manpower! All it took was an ample supply of water! The Karnak temple has a series of stone terraces, leading toward the river forming a kind of stairway known as "The Avenue of Sphinxes." Every terrace is 105 feet long, and Kunkel assumed they were remains of former water-locks, now filled in, on which the 67 monoliths could have been flooded up from the river straight into the temple and erected somewhat as the 80 ton door. The terraces are wide enough to make a dividing wall in their midst, gaining two locks on each level, one side going up the other going down. A modern parallel is the Welland Canal in Ontario, where overseas ships and lake vessels upsurge and descent around Niagara Falls. Are Kunkel's assumptions absurd?

When Herodotus visited the Great Pyramid about 1000 years after it was built, he was told that the preparations took 10 years and 20 years to build it. Also that during construction, it was uninterruptedly surrounded by water, IN AN ISLAND LIKE MANNER. Further, they raised the stones to their places by means of machines, formed of short wooden planks. The first machine raised them from the ground to the top of the first step, on which there was another machine that received the stone on its arrival and conveyed it to the second step, where a third machine advanced it still higher. Here Herodotus talks of machines made of short wooden planks which lifted stones from one step to another, not people moving them on wooden roles. The question is, what was a machine? We know that the contraptions used to catapult stones also were called machines, why not call

a water-lock a machine as well, as the doors were made of wood planks, as he also tells of seeing an old dry-dock, which was used by King Necos to repair damaged war vessels. How can one build a dry-dock, and not use water locks, as it was said, that the whole construction site was surrounded by water like an island? In Kunkel's opinion; "PYRAMID BUILDING WAS A BREEZE!" "A far cry from the popular concept of slaves hitched up like horses," Kunkel wrote. "A far cry from the rubbish, that is handled down from generation to generation, by men who should know better. To do such a job, steel rails and rollers could

not do it, even using our toughest steel beams and steel cables, and the slaves must have had superman power." The reason for such mal-conceptions lie in academic teachings which for many, turn into mental straightjackets, restricting reasoning to narrow channels as prescribed by authority and textbooks!

Yes, the Great Pyramid incorporates a pump. First it was needed to build it, secondly to discharge water over its sides for irrigation or rain making. The mystery still is, where is the pump, and from where did the ample supply of water come from as the Nile is far below? The pump is still there, visitors walk daily by or even through it with-

out knowing it, like not seeing the forest because of trees, and the ample water supply has a simple answer too, Herodotus will explain how it was in his time, 2,500 years ago, but the Great Pyramid was build about 1,000 years before him, reflecting the needs of that time. However, his writings give a clue and here it is. "When you are in a ship and a day's run from the land, if you let down a sounding line you will bring up mud and you are in eleven fathoms, (66 ft) because during the summer months the Nile brings down and deposits it in the Delta. At one time this Delta was a gulf. Below Memphis the soil is black and easily breaks up, as it is mud and silt. But the soil of Libya is reddish in color and rather sandy, while that of Arabia-Syria is somewhat loamy and rocky."

"The priest said that Menes was the first King of Egypt, and that it was he who raised the dike which protects Memphis from destruction by the Nile. He, by banking the river at the bend,

Figure 4

Rain through evaporation

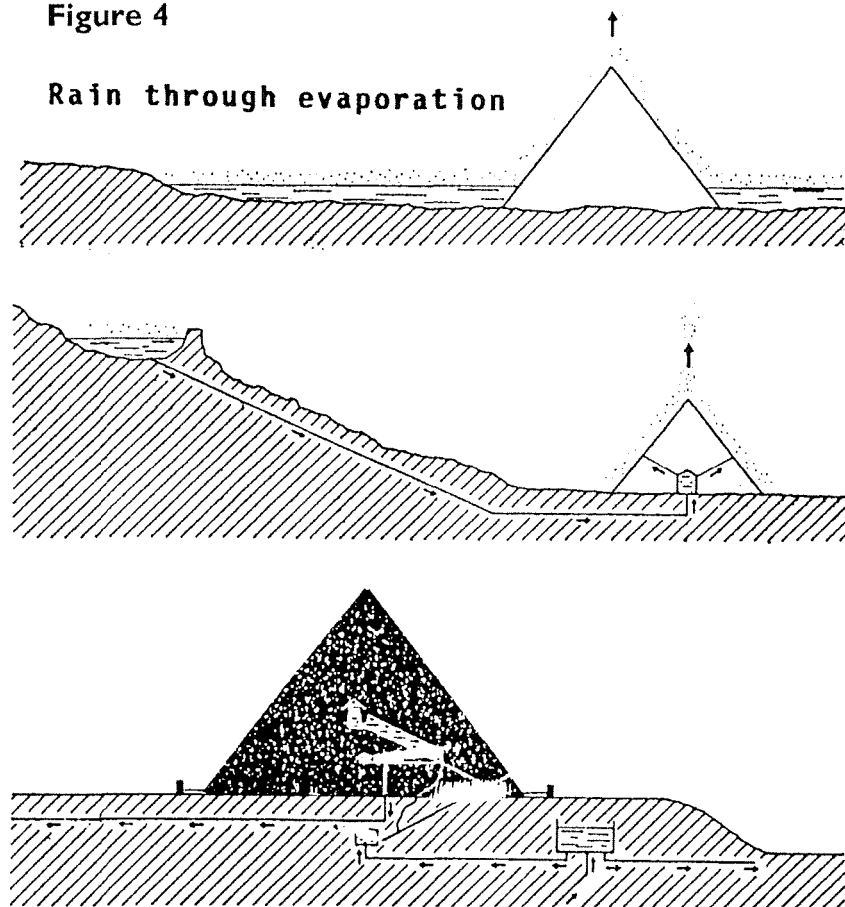

about a hundred "furlongs" (8 miles) south of Memphis, laid the ancient channel dry! He dug a new course for the stream, half-way between the two lines of hills. To this day (500 B.C) the elbow, which the Nile forms at this point where it is forced aside into the new channel, is guarded with care by the Persians, and strengthened every year, for if the river were to bust out at this point, and pour over the mound, there would be danger of Memphis being completely overwhelmed by the flood. Menes by turning the river, made the old tract where it used to run, dry land where he built the City now known as Memphis. He further excavated a lake outside the town, to the north, communicating with the river. The current sets up for six months into the lake from the river and for six months into the river from the lake." This lake was cleverly engineered. It had two functions, first it served as a flood control, and during the dry season as a reservoir, and third it gave the needed water to build the pyramids as the lake lies higher and here is the proof; "This Cheops, the priest said, reigned fifty years and after his death, his brother Chephren took over. This King built a pyramid, not attaining to the measurements of that which was built by the former, and moreover there are no underground chambers, NOR DOES A CHANNEL COME FROM THE NILE FLOWING TO THIS ONE AS TO THE OTHER." There was also danger of famine.

"The priest also gave me a strong proof concerning this land as follows. In the reign of King Moeris, whenever the river reached a height of at least eight cubits (1 cubit = 19 inches) it watered Egypt below Memphis, and just nine hundred years had gone by since his death, now, unless the river rises to sixteen at least, it does NOT GO OVER THE LAND. If the land below Memphis shall continue to increase in height, the Egyptians, who dwell here, will suffer famine if their land shall not have rain, nor will the river be able to go over their fields." A similar condition may have existed in Cheops' time, or had he foreseen such danger?

Three hundred and twenty eight monarchs after Menes, King Moeris enlarged the lake and Herodotus writes, "...a cause of marvel, even greater than the Pyramid's is afforded by the lake,

which is called the lake of Moeris. The measure of its circuit is three thousand six hundred furlongs (450 miles). The lake lies extended lengthwise from North to South, and in depth, where it is deepest, it is fifty fathoms (300). That this lake is artificial and formed by digging is self-evident, for about in the middle of the lake stand two Pyramids, each rising above the water to a height of fifty fathoms, the part which is built below the water being just the same height, and upon each is placed a colossal statue of stone, sitting upon a chair. Thus the Pyramids are a hundred fathoms in height."

Readers may think this lake with its two Pyramids, represents Moeris Vanity Fair? I see in it, the work of a wise man. A larger and deeper lake means more water for a longer time, and the Pyramids, with their large surfaces, will increase air humidity, giving a greater chance to induce rain. Different Kings used different methods. After Moeris came Sesostri, he turned the delta into an Egyptian Venice. Sesostri ordered to dig numerous canals with which the entire delta was changed. "Whereas Egypt had been formerly suited for horses and carriages, henceforth it became unfit for either. The King's object was to supply Nile water to the inhabitants not lying upon the river."

VINTAGE COMPRESSION CHAMBER EARLY 2,000 B.C.

Example: Bernoulli discovered that, if an orifice of a tube had clean sharp edges, and the tube was not longer than three times its cross-section, the discharge from such a tube will be increased by more than 25%, this is known as a principle of standard short tubes. While Bernoulli's theorem calls for a tube three times longer than its diameter, Cheops' pump has it nine times longer. This difference of proportion may be explained by the fact, that the Egyptians were working with a 100 feet head of water and a volume of 80 tons-plus, and Kunkel suspected that the discharge exceeded the maximum of 33%, which also indicates that the ancient hydraulic engineers knew more about Bernoulli's Theorem than Bernoulli himself! This also points to a negligible amount of water wasted to the amount pumped, whereon the modern ram pump wastes more water than it pumps!

To be continued.

Figure 5

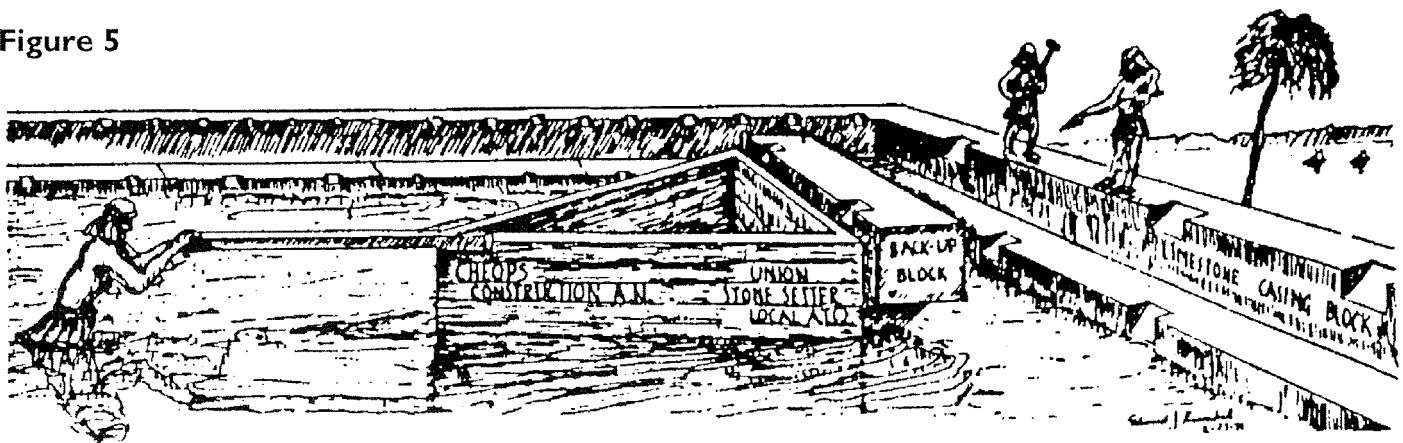

This undercutting of blocks was a common practice in temple wall construction. This type of a stone setting barge is imaginary. When the water goes down in the pool, the barge goes down with it, the stone is set on the wall and the barge pulled away.

E. Kunkel

The 'overunity' efficiency of electrical power generation in Space Power Generator (SPG) requires deeper understanding of the interaction between the magnetic field and dc power current that exist in this system of rotating electromagnet. Some modifications carried out in SPG, as discussed below, enable carrying out decisive experiments in the basic exploration of this phenomenon.

DESCRIPTION:

Refer Fig. 1. A cylindrical iron core has an electric coil rigidly mounted on it and energised through slipring 'S'. The magnetic flux produced in the core returns through the air gap in which three terminals made of non-magnetic rings are also located. The terminal 'A' is a stationary aluminium ring tipped with brushes that slide on the surface of the iron core rotated by a drive motor DM. The terminals 'B' and 'C' are made of

and back to the electromagnet's core. Since the output current and also the return currents flow within the electromagnet's core in opposite directions, interactions, if any, of these currents within the core with the magnetic flux in the core (due to electromagnet) cannot produce a net torque. Therefore if, within the airgap, due to currents through terminals 'A', 'B' and 'C' and magnetic flux there, no torque (either supporting DM's torque or in opposition to it) is produced, then this machine should be a totally free power system. The tests however show that the best efficiency of this machine is only 170% taking 0.8 as the combined efficiency of DM and the coupling between DM and SPG.

CONCLUSION:

When the terminals 'B' and 'C' are brought down close to the shaft through rigid links L1 and L2, the emf induced in each of the two electric circuits, from the core's centre and up to the terminals 'B' and 'C', falls to a value near zero, though the links L1 and L2 do not intercept any magnetic field during rotation. In the absence of relative motion between the links L1 and L2 and their respective circuits 'OC' and 'OB' where emf is generated, there is no net emf in the circuits.

In a co-rotating system of electromagnet's coil and its iron

Interaction of Magnetic Field and Power Current in Space Power Generation

by Paramahansa Tewari

non-magnetic stainless steel rings that are welded to the iron core and therefore rotate with it. Rigid connections with copper rods are made between terminals 'B', 'C' and respective sliprings P1 and P2. Brushes E1 and E2 located on sliprings P1 and P2 form one of the terminals for drawing power from the machine. The other terminal 'A' has a shunt connected to it for the measurement of dc current.

If the dc voltages developed in the core is V1 and that in the outer flux path V2, then terminal 'A' will have dc voltage V1 with respect to the shaft, and terminals 'B' and 'C' will have dc voltages that are approximately $(1/3)$ V1 with respect to the shaft. (The values of dc voltages at 'B' and 'C' depend upon the airgap and the radial thickness of outer flux return path etc.). The voltage difference between 'A' and terminals 'B' and 'C' is about $(2/3)$ V1. If the terminals 'B' and 'C' are brought down closer to the shaft as has been done in this machine through rigid links L1 and L2 the voltages at sliprings P1 and P2 will be very close to shaft voltage. (The shaft voltage is zero). Thus between the sliding brushes E1-E2 and terminal 'A', the voltage difference will be close to V1. When the machine is electrically loaded, power is drawn through brushes 'D', terminal 'A' and the shunt. The output current 'I' from 'A' divides nearly equally to E1 and E2, flows to machine through links L1 and L2, terminals 'B', 'C', located in the airgap,

core on which the coil is rigidly mounted, the magnetic flux within the core and currents in the core do not produce any torque due to mutual interaction.

The direction of currents flowing through the rings 'B' and 'C' is such that a torque in opposition to DM's torque will develop if magnetic field in the air gap does interact with these currents. Experiments, however, show that if the output current 'I' returns through the shaft (brushes 'K') efficiency of the machine slightly goes down from 170% to 140%. Therefore it can be concluded that the current in the air gap through the rotating rings 'B' and 'C' do not interact with the magnetic field which also rotates with the electromagnet's coil rotation. This also substantiates the above conclusion that current within the core cannot interact with the flux in the core since the coil producing the flux also rotates with the core.

The interaction in the airgap of currents in the rotating terminals 'B' and 'C', and the current through the fixed terminal 'A', as experimentally observed leads to only slight increase in efficiency. The source of generation of torque in opposition to DM's torque is thus traced to be the interaction between the airgap magnetic field and the output current through the stationary terminal 'A' located within the airgap.

Figure 1

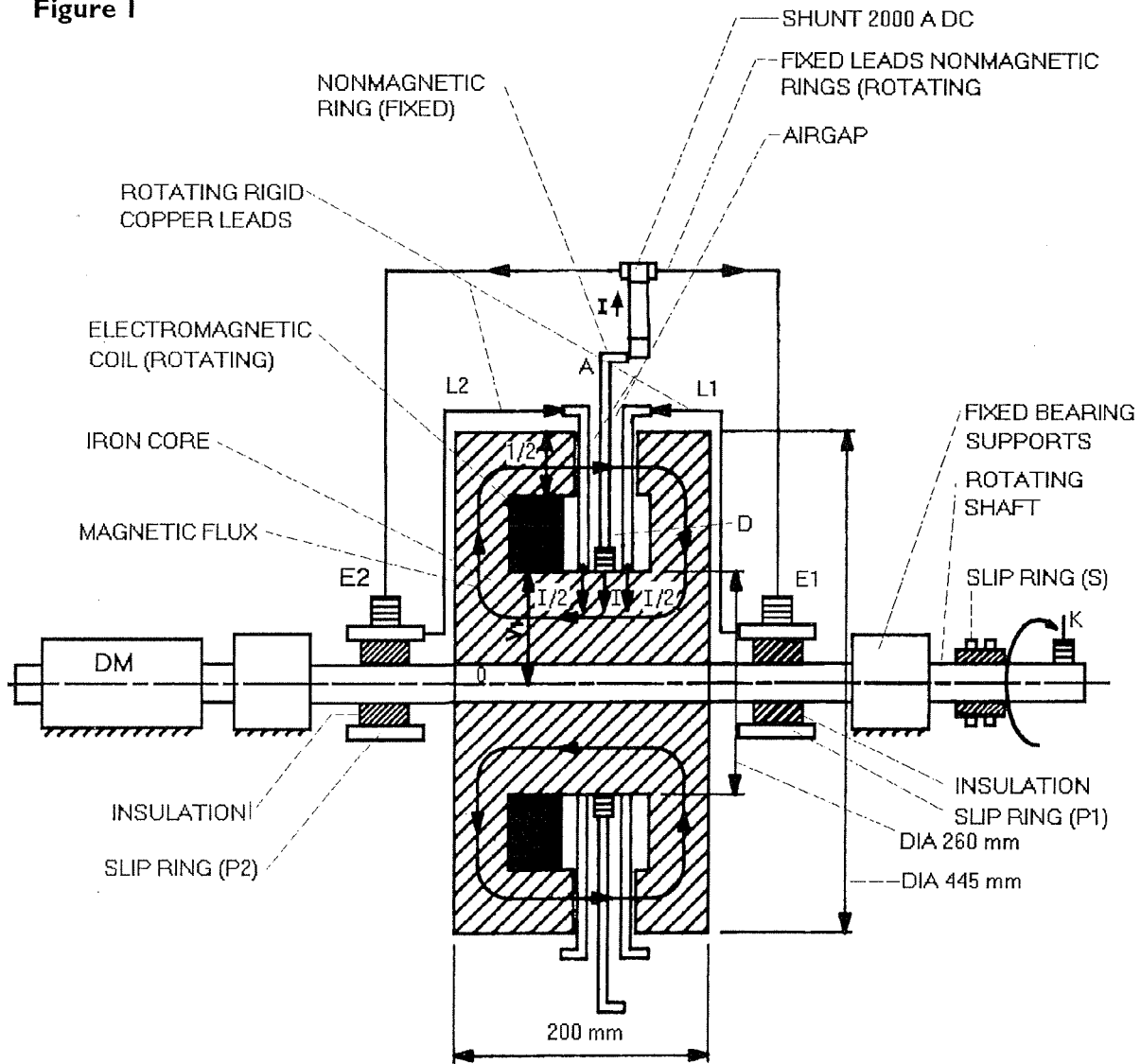

Weight of SPG	= 250 Kg	Output electrical current when loaded at 1500 rpm	= 1400 A DC
No. of turns in electromagnet	= 380	Electrical output of SPG	= 170%
No-load voltage at 1500 rpm	= 1500 mV DC	(Corresponding rise in electrical input) × 8	
Combined efficiency of DM and coupling	= 0.8		

REFERENCES:

- [1.1] Paramahansa Tewari, Physics and Technology of the Phenomenon of Space Power Generation. Proceedings of the Conference on Foundations of Mathematics & Physics, Perugia, Italy - 1989.
- [1.2] Paramahansa Tewari, Detection of Stationary and Dynamic Space Substratum. Raum & Zeit, USA, Vol. 2 No.1. 1990
- [1.3] Paramahansa Tewari, Electromagnetic Induction of Space Substratum. Journal of Borderland Research, USA - Jan-Feb 1992; Deutsche Physik, Austria, Vol.1 No.4 - 1992.
- [1.4] Bruce DePalma, 1187, Coast Village Road, # 1-163 Santa Barbara, California 93108, USA, On the Possibility of Extraction of Electrical Energy Directly from Space.
- [2] Paramahansa Tewari, Beyond Matter, Aligarh, India; Print Well Publications 1984.

ABOUT THE AUTHOR

Paramahansa Tewari is Chief Project Engineer at the Kaiga Project, P.O. Kaiga - 581400 Karwar, Karnataka, India

FIX KORN

by Peter A. Lindemann
with help from
Trevor James Constable

Unlike most of my previous articles, this one is a grab-bag of loose ends, tied together artfully to weave a wondrous tapestry of floor clippings. Whatever their relatedness or significance, I offer them to you thus...

I would like to begin by thanking everyone who took the time and effort to send me information on Stirling Engines and allied technologies. The collection is considerable at this time and it shows that a great deal of work has been done along these lines over the years. While I have read much of the material and thought about engine designs for many hours, the project has been set aside at this time for two reasons. The first reason is that I am generally kept busy with making a living running my own business. The second reason is that I now believe some sort of financial backing will be required to successfully develop a Stirling cycle power plant. So, the project sits in a big folder in my file cabinet, awaiting a more auspicious moment in time or a change in financial circumstances.

Next, in a follow-up to my last article about the Lakhovsky MWO, continuing experiments are yielding what appear to be increasingly gratifying results. The standard air spark-gap has now been replaced by a series of preset, glass enclosed, vacuum quenched spark-gaps. Also, I have retrieved the high voltage output coil built by Klark Kent and modified it as follows. First, I disconnected the primary from the secondary and removed the primary winding completely. I now have 5 turns of wire in the primary coil and it is located around the center of the secondary coil, instead of down at one end. With the outer ring of a multi-ringed MWO antenna attached to each end of the secondary coil, the electric discharge coming off the outer ring is quite remarkable. The discharge is a combination of very fine, wispy sparks and a violet colored vapor. Even though the discharge extends out over two inches, there is only an occasional "spark" to the second ring which is only 5/8ths of an inch away. It is possible to draw a spark off any of the other inner rings by approaching them with a metallic object, proving that they are properly energized by induction as Lakhovsky specifies that they should be. The unit also produces significant quantities of ozone when running. Interestingly, the discharges are much more inclined to jump to my finger than to a metal screwdriver. In the dark, when my finger approaches any of the energized components, the violet colored vaporous discharge

appears to emerge from my finger and move toward the circuit. Only when I get closer does a "spark" jump with its attendant discomfort. The vaporous discharge causes no discomfort at all. The unit is being placed in the hands of a competent researcher and hopefully in a few months we will know if these circuit changes yield better clinical results.

The next step is to build a second unit and use it to power a true Lakhovsky style multi-ringed antenna made of copper tubing suspended on silk threads as the patent specifies. Hopefully by this summer, we may have a true Lakhovsky style MWO available for experimental use. Anyone interested in owning such a device should contact BSRF and talk to Tom Brown.

Also, I would like to inform our readership of a relatively new and officially ignored phenomenon that is occurring worldwide. I refer to an effect that is being called "white sky." I was first introduced to this event in August, 1992 when Trevor Constable called me and told me that the skies over Hawaii were colorless and that none of his weather modification equipment had any effect. The whole sky was unpatternable and would not respond to the injected impulse of Trevor's equipment. All the blue was gone from the sky, except for a pale narrow band near the horizon. Even the sunsets, which are usually quite a spectacular display of color in Hawaii, were just a glaring white sun setting in a white sky. The sunlight was harsh on the eyes and the skin. Trevor told me that in all his days of observing the sky, he had never encountered anything this extreme but that he had started seeing it earlier over other areas of the Pacific Ocean during his last tour on the SS Maui. This "white sky" over Hawaii was eventually broken up using a Spider Unit in conjunction with a SpaceCrafter. After this combination of equipment was used persistently, the sky around Hawaii slowly returned to its natural state with blue sky, colorful sunsets and periodic rain.

Being self-employed in my own home, I periodically turn on CNN to catch some news while I eat lunch. Quite often they show a satellite picture of the whole United States during the weather report. By October, 1992, I started noticing that the country was usually covered by a light haze. Sometimes, in a time-lapse sequence of satellite shots, this haze would clear from Mexico all the way up into Canada within a one hour period, only to return about two hours later sweeping down from Canada to Mexico. This was obviously a huge meteorological event, but the "weatherman" ignored it completely, using his time to discuss the standard rain producing fronts. This continued to occur throughout November and December of last year. Then in December sometime, CNN started showing a composite satellite picture of the whole globe in a section they called the "World's Weather." I was shocked! What this global satellite picture showed then and still shows now is that the equatorial regions of the planet have a relatively clear sky with the other usual weather features, but that starting at about 25 degrees north and south latitude, the sky becomes hazy. This haze progressively becomes thicker toward the polar regions. These haze belts completely circle the globe. No region is exempt. Even in high pressure systems, when the sky is without other clouds, the haze is there. Here in Oregon, on "clear" days now, the sun looks white and is surrounded by a large area of white glare. The rest of the sky does look blue, but it is a much lighter shade of blue than it used to be.

I
N
I
X
K
O
R
N
E
R
!
?
!
?
!!

The question is.. what's happening? The most obvious speculations center on high altitude ash from the Mt. Pinatubo eruptions of 1991. While this explanation may seem likely to the untrained eye, there is no evidence one way or the other to prove that is the right one. Satellite photos in the months following Pinatubo's eruption showed the ash in a visible band covering at least 15 degrees on each side of the equator. LIFE magazine reproduced these photos showing this material presence. Having watched the behavior of this haze on satellite pictures now for months, I do not think it is made up of particulate matter. Here are a few reasons why I think it is something other than high altitude ash. The sunsets after Pinatubo were deep red. In fact, volcanic ash sunsets are historically reported to be red. What is happening now does not produce red sunsets. The haze clearing over vast areas (the whole width of the US) in an hour when the sun is high in the sky, only to return as the sun moves to a lower angle, suggests to me that the phenomenon is essentially etheric in nature and not the behavior of particulate matter. No wind could disburse 2 million square miles of dust in one hour, only to have it reappear three hours later. Also, Mt. Pinatubo is located at about 18 degrees north latitude. Why would the dust completely clear from this region and now be redistributed in the polar regions, both north and south? That makes no sense to me.

Obviously, the haze is a high altitude event that centers at the polar regions. The only other thing that is happening that fits that general description is the "ozone hole" phenomena. Could the two be related? I don't know. The "white sky" haze now covers over half the surface of the globe on a continual basis. That is a much larger event than the "ozone hole" problem which we are told is seasonal and more localized. Whatever it is, it reminds me that in 1951, Dr. Wilhelm Reich declared an atmospheric emergency. After 42 more years of abuse, the etheric forces of the globe could be reaching their elastic limit. This is what I suspect is happening. The atmosphere may be approaching a condition where it is incapable of self-correction at a very fundamental level. If this is true, it represents an etheric disturbance of vast magnitude. Since the "weather" follows the behavior of the chemical ether, and since the chemical ether penetrates both the sky and the ground, we may be on the leading edge of a series of very disruptive and wide spread events. Extremes of weather,

such as the unprecedented violence of Andrew, and the storm of the century that paralyzed the Eastern U.S.A. in March 1993, seemed likely to continue. Such events are all strong contractions of the Chemical Ether. The way the "white sky" cleared from Trevor's operation in Hawaii strongly suggests to me that at least that aspect of it was related to Oranur. If the rest of the "white sky" event is also related to Oranur, this planet is up to its lip in buffalo chips!

Finally, last August, when my wife and I were returning to Oregon from a trip to Colorado, we came through southern California to visit my brother who still lives in Santa Barbara. As we passed through the Palm Springs area, we stopped for lunch. Here, near the area of the Landers quake of two months earlier, the ground felt oddly "hollow" to me. I had never felt anything like it before. It was eerie. Since then, Trevor Constable has been in and out of the area a number of times and reports to me that this "hollow" feeling, which he is also aware of, has progressed and become much worse. The etheric forces there are becoming distorted in a way and at a magnitude that is unprecedented. What this all means, I do not know. To me, the ground has felt "disturbed" in southern California for years and I have monitored these feelings for quite some time now. This "hollow" feeling is quite new, however, and definitely was not present when I visited the area in 1986 when Tom and Eric Dollard were working at the "Integratron."

Some of you may be aware of the extreme earth changes predicted by Gordon-Michael Scallion including a series of very large earthquakes due to hit southern and central California before May 9, 1993. These predictions describe destruction at heretofore unimagined levels. I view the coincidence of the build-up of these huge etheric distortions and the convergence of Scallion's predictions for the area with alarm. I believe something big is definitely brewing.

I do not know if the "white sky" phenomena is related in any way to the "hollow" feeling building up in the ground in southern California. Both seem to be extreme disturbances of the etheric forces at levels of magnitude that nearly frighten the trained observer. In any event, I believe we may be on the threshold of finding out the meaning of the old Chinese curse: "May you live in interesting times."

GRAVITY IS A PUSH!!!

My 23 minute "high grade" VHS video tape, PUSH-GRAVITY PART #24, has been receiving, as they say in Hollywood: "RAVE REVIEWS." In the NOVA presentation, TO BOLDLY GO, they demonstrate four of their five "findings" within Saturn's rings with PUSHES in one way or another. Their fifth "finding", in my opinion, is explained in a very confusing way. NOVA's 5 "findings" are shown in my tape. I also observed 3 other "findings" in Saturn's rings. All of these 8 "findings" are demonstrated in my tape with my models that operate under their own self-contained "repelling energies" supporting my push-gravity theory. NOVA demonstrates these 5 "findings" in animation, WHY??? NOVA never mentions Newton's pull-gravity law, WHY??? I received orders for my tape during JUNE 1992 from Alaska, Canada, Mexico, California, Nevada, Arizona, Colorado, Texas, Oklahoma, Missouri, Kansas and Arkansas. I'm hoping that you will order this tape, too, so you can give PUSH-GRAVITY the exposure it deserves. If you have already, then THANKS. These tapes would make an ideal birthday present, etc., for someone you know that has an interest in spacescience. My tape is only a \$10 donation, which includes handling and postage. I can mail it to you or to a person of your choice with a card enclosed stating it is a GIFT from you. **From W. C. WRIGHT, 732 OHIO ST., FAIRFIELD, CA 94533, (707) 429-0598.**

UNITED STATES PATENT OFFICE.

JOHN S. MELLON, OF ST. LOUIS, MISSOURI, ASSIGNOR OF SIX-TENTHS TO G. W. LEWIS, OF SAME PLACE.

ELECTRO-THERAPEUTIC APPLIANCE.

SPECIFICATION forming part of Letters Patent No. 412,196, dated October 1, 1889.
Application filed June 22, 1889, Serial No. 315,253. (No model.)

To all whom it may concern:

Be it known that I, JOHN MELLON, a citizen of the United States, residing at the city of St. Louis, in the State of Missouri, have invented a new and useful Improvement in Electrical Appliances, of which the following is a specification, reference being had to the accompanying drawings and claim.

My invention relates particularly to health-giving appliances, which are adapted to generate galvanism and to both induct and educt electrical currents in connection with the human system, and to equalize such currents between it and the earth.

The invention consists of one or more galvanic pairs made of metals, which are adapted to be excited electrically by the moisture of the human body acting chemically upon the differing kinds of metal in the couples, and a metallic conductor or eductor for connecting such couples with the moist ground and with the body under treatment.

The accompanying drawings illustrate some mechanical devices for its construction.

Figures 1, 2, and 3 are views of different forms of it.

Similar letters refer to like parts through-out the several views.

It is well known that changes of conditions in matter cause changes in the electrical forces, and such changes are constantly occurring throughout nature. The human system is subject to such changes, whereby it at times is liable to be injuriously surcharged with or minus in its normal healthy electrical condition.

The object of my invention is to cure various diseases and to restore and retain health by keeping the electrical conditions of our bodies always in harmony with those of the earth, from which we have originated, so that a person in any part of a house may be in direct electrical contact with the moist earth, the same as if standing upon it.

In Fig. 1 the galvanic pair A is made of two sheets, one of copper C

and one of zinc B. The copper overlaps the zinc, and they are fastened together at one of their ends by rivets or otherwise. The ground-conductor D is a copper wire or any other suitable electrical conductor, and is properly attached to the copper and zinc pair. It extends from them down into and is buried in the moist earth. It may or may not have the ground-plant E attached to it.

In Fig. 2 the pair A is similar, except in its construction, to the pair in Fig. 1, the face of the zinc sheet B is laid on the copper sheet C, the ends of which fold over the zinc, and is adapted to be electrically excited by moisture from placing one hand on the copper and the other on its zinc plate.

Fig. 3 is a galvanic pair of handles united together by the conductor D.

C is of copper, and B of zinc, both made of sheet metal. Each of the last two pairs named have the ground-connection D, with or without the plant E. These pairs may be made in any shape or form or size, and of any metals which are adapted to be excited electrically by the moisture of the hands or feet and other parts of our bodies acting on the metallic couple, while the grounded end of the conductor D is in contact with the moist earth. By standing with the moist feet on the pair, or holding the hands thereon, or holding the handles in the hand, galvanic currents are generated in them to supply any deficiency of electricity which may exist, and means is thus provided for all electrical currents to interchange and establish harmony and equilibrium between our bodies and the earth. For invalid uses, where they are confined to beds in upper rooms, it is only necessary to lengthen and attach the conductor to suit the situation.

I am aware of other electrical appliances which are applied to local parts of the body for the treatment of diseases—none of which, however, have any ground-connection. Such I disclaim. I am confident, however, that much greater benefits would accrue to the afflicted from the use of such devices if they were used in connection with my invention.

What I claim as my invention, and desire to secure by Letters Patent of the United States, is—

A galvanic pair the electrodes of which are adapted to be artificially excited electrically by the moisture of any part or parts of the human system or that of any other organized life from its contact therewith, in combination with a ground-conductor connecting the pair with the earth, substantially as described.

JOHN S. MELLON.

witnesses:
HUGH M. THOMPSON,
C. C. LOGAN

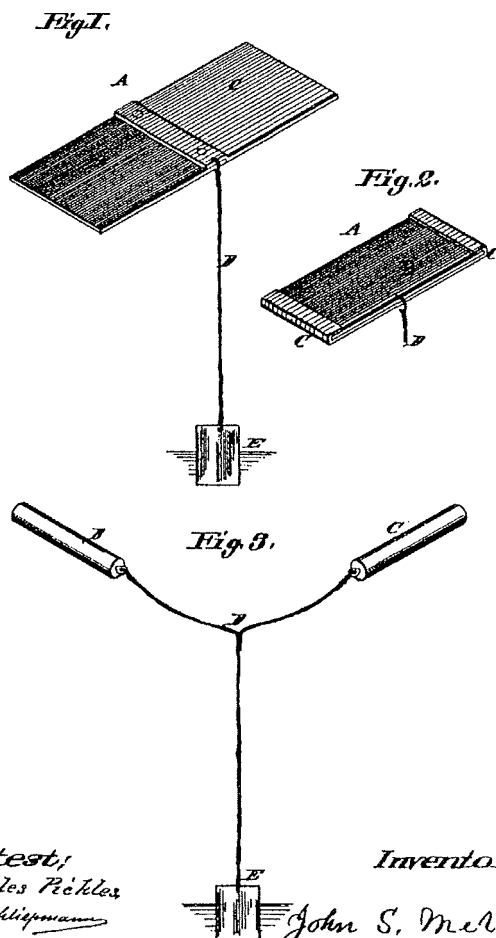

Attest:
Charles Pickles
Notary Public

Inventor:

John S. Mellon
by H. M. Thompson
att'y

Paradigm de Jour

Gray Aliens Bite the Dust

by **Illson Davidson**

A fiction no matter how bizarre, if repeated often enough becomes accepted as fact especially if it's reinforced by the voice of some Authority or other. This goes on all the time, especially in the media and their propaganda bulletins passed as network news, to take an obvious example. But the frightening thing is that once a fabricated belief is established in the mass mind, anyone who tries to expose the original fiction is almost certain to be set up as a liar, a lunatic, or worse...

Fortunately for us there are still lunatics in the world who pan for truth in the polluted rivers of disinformation. Borderlands has long been one of those rare places where the odd, the avant garde and heretical have found their voice. For example, way back in the 1950s, long before UFOs became popular Borderlands was seriously investigating this phenomenon and over the years has observed and recorded all the extraordinary and bizarre developments in this field, always with a mind open to the infinite possibilities of a greater reality. In the early days of Ufology the extraterrestrial contacts claimed were usually of the benevolent space brothers type (Ashtar command), Adamski's voluptuous blondes from Venus, etc. It was all rather harmless and the messages were even quite inspiring — never mind that the technical information on how to 'get there' never quite materialized. People believed what they wanted and reached out to other worlds and other possible states of consciousness, perhaps for the first time in their lives. It became a movement.

But over the past few years everything has changed. A disturbing element has entered the once bright arena of ufology and a shadow hangs heavy over the whole question of extraterrestrial contact. Somehow, since the mid-seventies, the storyline has been twisted, the stereotypical image of the 'space people' has been subtly and deliberately altered to reflect a very different mood. According to the proponents of this new wave of Ufology, extraterrestrial contact isn't desirable anymore — unless you happen to be a masochist with a penchant for painful 'medical' examinations of a sick sexual nature. One thing is for sure — the space people aren't benevolent any more; they're cold and gray and their intentions are increasingly sinister — they want to control your mind, and steal parts of your body.

This about-turn in the field of ufology, I mean 180 degree turn, from the white voluptuous fantasy to the politically correct 'grays' (these aliens are neither white nor black) is quite remark-

able. While claims of the earlier and more esoteric extraterrestrial contact were mocked by most normal people including the media, now the media is becoming saturated with stories of alien abductions and those same sane people are parroting all the latest details. There's a belief here verging on hysteria; so where, we have to ask, are these stories coming from? And if they're true — *show us the evidence!*

ENTER THE GRAY ALIENS

The two main images in the lurid ufology sweeping into public consciousness today are — *gray aliens* and *abductions* of humans by these aliens. Together they form the key components of a cosmic conspiracy theory with elements of high level

government involvement and mass genetic manipulation, to say the least, and it's a conspiracy that's spreading. A postcard just received in the mail from Paramount Pictures states that "2.5 million Americans claim they have had an alien abduction experience", as part of their promotion for the upcoming release of a major movie called *Fire in the Sky* very loosely

based on the Travis Walton incident well known to ufologists, one of the early abduction cases which has been neither proven or refuted.

The image of gray aliens is infiltrating the gray matter of the public like the sinister shadow reflex of those ubiquitous little troll dolls, insinuating itself into every level of the media. Grays are finding mention in television shows, such as the documentary *A Strange Harvest*, the TV movie *Intruders*, a recent episode of *Star Trek the Next Generation*, that well known prototype vehicle for the New World Order federation propaganda... advertisements, almost every new age consciousness publication, gutter press and otherwise intelligent magazines. Their mutated bland bug-eyed heads have sent ET back to kindergarten. Abductee has become a fashionable state of being and abduction seminars, workshops, support groups and private counselling for abductees are spreading like an epidemic.

Here at Borderlands under siege from the stacks of hype from the New True Believers, we have also received information from the other more skeptical side of the story and this article is an attempt to gather together some of the kernels of truth, if truth is to be found, from the bloated fiction being sold by the sensation hungry press to the ever gullible public.

“A detailed examination of the phenomenon demonstrates that no credible evidence exists to support the objective reality of alien abductions.”

THE PSYCHOLOGY OF ABDUCTIONS — WEAK LINKS IN THE CHAIN

One of the most rational and scholarly investigations into the claims of human abduction by extraterrestrials is a meticulously researched paper published recently by the International Fortean Organization, titled *Demons, Doctors, and Aliens* by James Pontolillo, subtitled: *An Investigation into the Relationships Among Witch Trial Evidence, Sexual-Medical Traditions, and Alien Abductions*. But don't expect to find any serious review of this work in the mainstream ufological press, as James Moseley of the *Saucer Smear* cynically comments: "If it ain't real-life aliens, true ufologists don't want to hear about it!"

The author is concerned about "the central role of cultural misogyny in the origin and development of the alien abduction phenomenon"... the shallow contradictions and misrepresentation of facts in the reports, and the lack of substantiating evidence... as he says, "nothing but the human imagination is required to produce an abduction narrative."

"The proper stake to be driven through the heart of the deathless abduction nonsense has yet to be found".

He begins by questioning the numbers of alien abduction cases claimed by such prominent researchers as Budd Hopkins (100's of 1000's — or 1 million last count), or Donald Ware from MUFON (approximately 6 million Americans "whether they know it or not"). The figures claimed are extrapolated from individual cases (including friends and acquaintances) to the general population, and from a poll containing five leading questions that was apparently distributed to several thousand people, and quoted in Fate magazine. Have you ever experienced missing time... felt you were flying... awakened with a strange presence in your room... seen unusual lights... found puzzling scars on your body...? You might be an abductee and not know it. This is the theoretical basis of the abductionists' extravagant claims (but they don't ask if you take drugs, drink alcohol, engage in subtle energy practices, or watch too much TV...)

Skeptics, of course, deny that anyone has ever been abducted.

Pontolillo goes on to question the evidence of which the overwhelming majority is unsubstantiated eye witness (and alleged eye witness) testimony from the purported abductee. Most abductees are anonymous and the crucial medical and psychological documentation on their cases is inaccessible. He questions the use of hypnotic recall procedures by pro-abduction therapists with little knowledge of the scientific literature on hypnosis and its proper application. Most of the abduction evidence hinges on hypnotic regression and, as Pontolillo points out, "a casual examination of all major pro-abduction books reveals the use of leading questions by researchers on their hypnotized subjects" — while Hopkins categorically states in *UFOs And The Alien Presence*: "You can't lead people." (Another question that presents itself here is: How is it humanly possible to conduct in-depth psychological tests for such a vast number of traumatized victims — if their claimed numbers are true?)

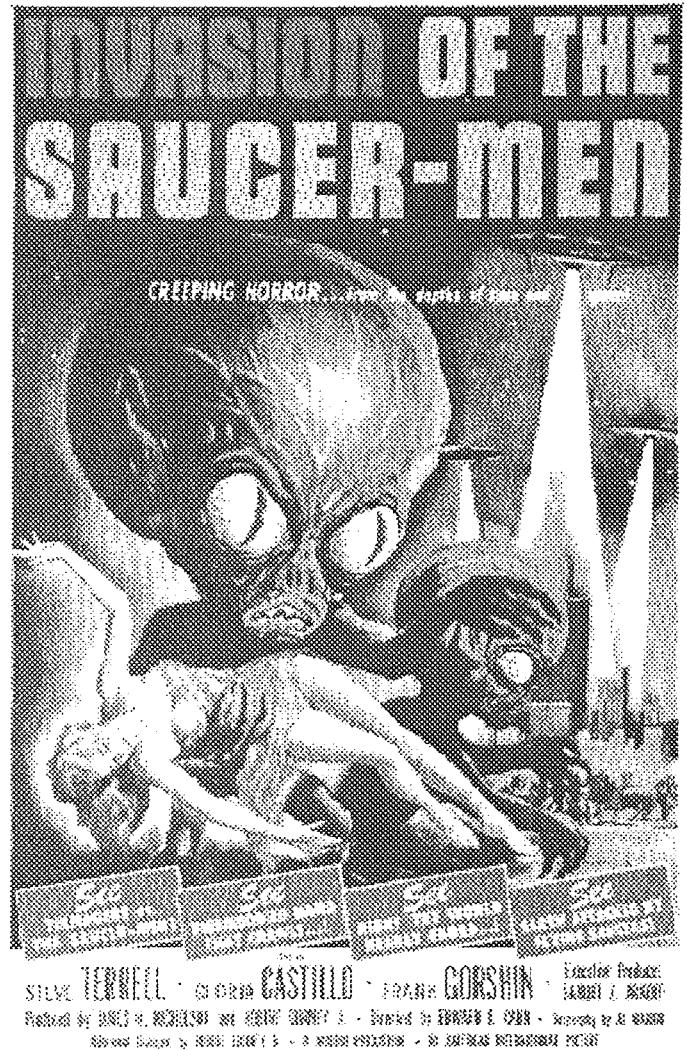

They were at it in the Fifties!

As there is *no physical evidence or objective testimony* the author digs more deeply into the psychological interpretation of the abduction phenomenon to seek out the underlying archetypal imagery. In doing so he draws a compelling thread between UFOs, abductions and ancient folkloric tradition, or as he puts it "The core abduction event, sexual and medical experimentation by extraterrestrials on unwilling human (primarily female) subjects, is only the latest variation in a time-worn cycle of misogynistic folk tradition endemic to Western civilization."

He takes the reader back to the first abduction story ever recorded, in Genesis, with the sons of God *taking* the daughters of men, beginning a cycle of domination and abuse of women not merely tolerated but aggressively pursued by the Judeo-Christian authorities. In the early days of the Church, intercourse between female saints and angelic lovers in male form was quite acceptable, as was the idea of human-angelic interbreeding, but later on woman was made into the evil seductress, the insatiable succubus depicted lewdly cavorting with demons. The sadistic trials of the Great Witch Hunt (15-17th century) with their countless victims, mostly women, were a direct result of this misogynistic mythology, and the physical and sexual torture of the mediaeval inquisitors with the lurid confessions extracted from their helpless

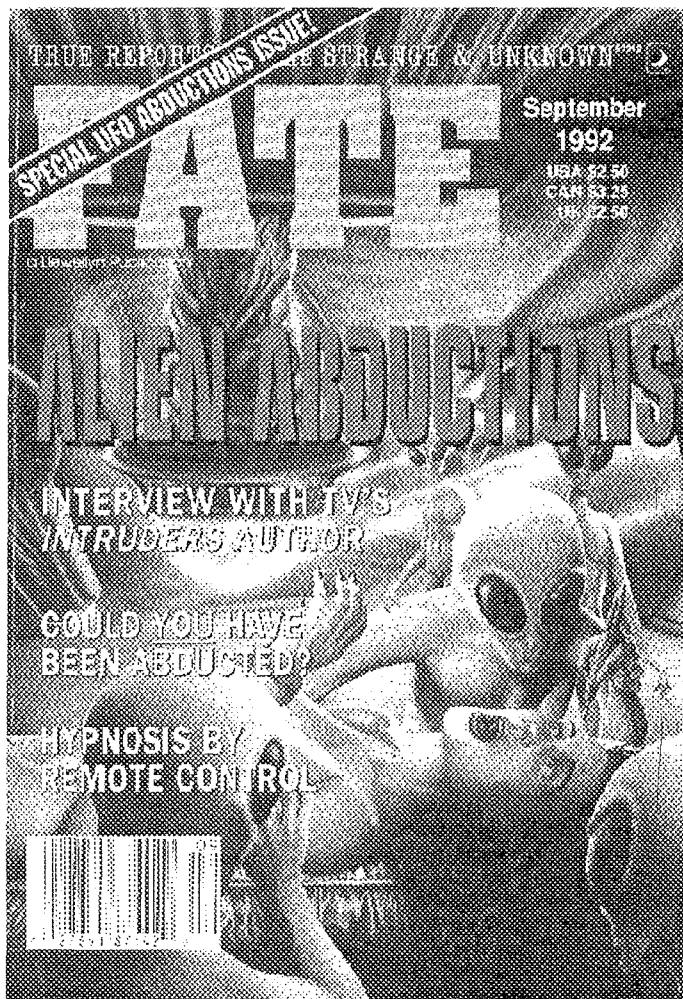

More gruesome in the Nineties.

victims were only a few steps away in time from the “scientifically proven” fledgling disciplines of crude gynecology and psychiatry. It’s chilling but true that normal female sexuality in the 1800s was ‘treated’ with flogging, clitoridectomy and female castration. As Pontolillo states, these are the roots from which much of our 20th century philosophical, intellectual and scientific modes of thinking grew. Under the cloak of science, intercourse with the supernatural faded from public view but in the mid 1950s it returned in another guise, the early contactees such as George Adamski, and an increasingly religious tone to the UFO encounter. It was in the 1960s that the claimed abductions of Betty and Barney Hill, Antonio Villas-Boas and Betty Andreasson-Lucas were reported, setting the theme for all subsequent abduction stories. While abduction proponents claim the media had no influence on the reports of these famous cases, Pontolillo points out the great tide of pulp sci fi magazines and movies conveying “the paranoia about alien visitors that had permeated American culture and its resultant influence on the development of the alien abduction phenomenon” with examples like the ’39 novel *Sinister Barrier* where extraterrestrials artificially inseminate human women, or the ’57 film *The Mysterians* where alien men take human wives for breeding purposes.

The media hype following the Betty cases saw a phenomenal upsurge in reported abductions and with them a return to the

mythic theme proposed by the author. The blatantly sexual medical procedures practised by the aliens on the abductees uncannily echo the reports of the demonic liaisons extracted under the inquisitor’s torture — the icy demonic phallus becomes a cold instrument inserted by aliens; the ‘pricking’ of the accused witch becomes a recurrent needle motif in the alien ‘medical’ examinations; some of the aliens copulate with the women but there is no pleasure involved, and human interbreeding with fairies or demons is transcribed into alien genetic manipulation, forced interbreeding, the stealing of ova and sperm and brief pregnancies with the fetus mysteriously vanishing into yet another unverifiable report — *while the experiences of male abductees have received very little attention.*

As Pontolillo states: “*The abductee testimony of various medical and sexual experiences is a convoluted mix of lurid dream imagery, confabulated medical and sexual experiences, and iatrogenic effects.*”

While he focuses on the psychological aspects and the mythic quality of abduction reports the author also brings up the subject of devices allegedly implanted in abductees’ bodies by aliens for purposes of tracking and mind control, although it seems none of these implants have been made available for independent scientific evaluation — they have the habit of “vanishing mysteriously, being lost in the mail, misplaced, stolen by unknown entities or seized by unnamed federal agents as the ufological worldview usually requires.”

THE SINISTER WORLD OF ‘SPY-CHIATRISTS’

Another nail in the coffin of the gray alien syndrome is added by Martin Cannon in a manuscript entitled *The Controllers: A New Hypothesis of Alien Abductions*, in which the author asks some pretty basic questions that seem to be conveniently overlooked by the abduction proponents. Firstly, “How do we know that the abductors are alien at all? And if the abductees are placed under some kind of mind control through implanted memory as claimed by Budd Hopkins and others: How can we trust the perceptions of someone whose perceptions have been altered? What if the kidnappers were actually human beings, using advanced hypnotic techniques to create the ‘alien’ screen memory?”

Cannon doesn’t question the validity of the abductee experience, but rather he seeks to unravel the deeper layers of the mystery from a pragmatic and definitely Earth-oriented approach. With a formidable list of resource references he puts forward his case that the claimed UFO abductions might well be a continuation of clandestine mind control operations including hypnosis, drugs, psychological conditioning, microwaves, brain implants and even more disturbing technologies. Having spent a great deal of time reading, researching, contacting other researchers and conducting interviews, Cannon has come up with shocking evidence of the sinister and covert world of the “spy-chiatrists” who have been experimenting with mind control technologies for decades.

He says: “If my hypothesis proves true, then we must accept the following: The kidnapping is real. The fear is real. The pain is real. The instructions are real. But the little grey men from Zeti Reticuli are *not* real; they are constructs, Halloween masks meant to disguise the real faces of the controllers.”

And who are the controllers?

“Substantial evidence exists linking members of this country’s intelligence community, including the Central Intelligence Agency, the Defense Advanced Research Projects Agency and the Office of Naval Intelligence, with the esoteric technology of mind control.”

He traces clandestine behavioural research going back to World War II with the developing tools of hypnosis, truth drugs and a pharmacology of chemicals. After the war the Navy continued this research, then in 1950 the CIA began its own mind control program with Project BLUEBIRD, which became ARTI-CHOKE and later MKULTRA, regarded by some as the most heinous of all the CIA’s disreputable covert operations — with its most secret area of study being psychoelectronics. That these programs existed is an established fact, as the author states “...the existence of mind control was verified in two (heavily compromised) congressional investigations and in thousands of FOIA documents.”

For those who doubt the power of mind control over unsuspecting victims, he includes this anecdote about a MKULTRA veteran and author on warfare hypnosis George Estabrooks, who “once amused himself during a party by covertly hypnotizing two friends, who were led to believe that the Prime Minister of England had just arrived; Estabrook’s victims spent an hour conversing with, and even serving drinks, to the esteemed visitor.” As Cannon asks “If the Mesmeric arts can successfully evoke a non-existent Prime Minister, why can’t a representative from the Pleiades be similarly induced?”

As far back as the 60s, he states, and possibly earlier, scientists have had the means to create implants similar to those claimed by abductees. Around the late 50s a neuroscientist named Jose Delgado invented a device known as a “stimoceiver” — a miniature depth electrode which can receive and transmit electronic signals over FM radio waves. With this the controller can wield a surprising degree of control over the response of the subject, playing the emotions electronically “as easily as a musical instrument.” Delgado stated quite clearly in 1966 that “motion, emotion and behaviour can be directed by electrical forces and that humans can be controlled like robots by push buttons.” Other researchers have induced memory, sexual arousal, fear, pleasure and hallucinations in their subjects, and devices have been created for tracking people over long distances, leading to “electronic house arrest” devices approved by the courts. (Mind machines of a supposedly more innocent nature have also become commonly used in New Age circles, such as the Synchro-energizer, TENS machine etc.) The early implants were soon replaced by tiny miniaturized intracranial receivers, which in turn have been superseded by microwaves and other forms of electromagnetic radiation to elicit mind control. How far the technology has progressed is hard to monitor, Cannon admits, as the press stopped reporting on brain implantation in the early 70s, but journalists have asserted that the CIA now has mastered “Radio Hypnotic Intracerebral Control” and “Electronic Dissolution of Memory” — being able to induce hypnotic trance, give suggestions, and erase memory (“missing time” is a common claim of abductees), all at a distance and “triggered at will by radio transmission” surpassing even the sophisticated horror of *The*

Manchurian Candidate. Intramuscular implants have also been developed with the small resultant scars reminiscent of abductee reports.

Perhaps the most ominous proposals for mind-management, says the author, come from people like Joseph A Meyer of the National Security Agency who proposed implanting tens of millions of “subscribers”, as Meyers put it, (about half of all Americans arrested) who could be under constant computer surveillance wherever they went. As this frugal fellow stated, “implants are cheaper and more efficient than the police.” And the operation can be done right in the office taking less than 20 minutes, as a Florida doctor brags, who also suggests implanting children with transmitters for constant monitoring for their own safety! With such sophisticated techniques at their disposal Cannon asks the key question: *Why are ‘advanced aliens’ using old Earth technology?*

It all sounds very fishy and yet the lure of the little gray alien has been swallowed by otherwise intelligent people, hook, line and sinker. “Perhaps,” says Cannon, “one purpose of the UFO abductions is to engender and maintain the legend of the little gray aliens. For the hidden manipulators, the abductions could be, in and of themselves, a propaganda coup.” (It may be mere coincidence but “ex”-intelligence agents are very prominent in such highly sophisticated disinformation schemes as the ‘cosmic conspiracy’, the UFO and alien abduction plot, e.g. John Lear, William Cooper, Bob Lazar, etc — although on a recent radio show both Lear and Cooper were both heard back-peddling on the alien angle of the conspiracy caper). But for what purpose? One chilling possibility put forth by Cannon concerns “the disposal problem” of the mind-control experiments, or “What do we do with the victims?” Another possibility is to prepare earthlings for a simulated alien invasion which could bring into effect an international state of emergency — remember the film *The Day The Earth Stood Still?*

CATTLE MUTILATIONS

Another atrocity that has been linked to alien abductions by the thinnest threads of evidence (so thin as to be practically invisible) is the disturbing cattle mutilation enigma. In one case a young woman claimed she was taken by aliens to a facility where they were processing the body parts of a mutilated calf. In the New Mexico area where cattle mutilations have occurred, strange lights have been repeatedly seen in the sky along with other unusual activity such as helicopters that can be seen but not heard, or heard but not seen. Common in abductee accounts is the memory of a helicopter turning into a UFO. According to George Earley who in a Fate interview with Hopkins is surely fantasizing about equipment on an alien space ship: “Such equipment might function in a manner similar to the Klingon cloaking device in the *Star Trek* TV series.” And in a similar vein Linda Moulton Howe, creator of the TV film *A Strange Harvest*, and a major media proponent of alien abductions, states “...they (the grays) have the technology to camouflage themselves however they want to.”

Drawn into this highly contentious area was Peter Jordan, author of *The Psychometry of Cattle Mutilation*, and founder/director of the Association for the Study of Unexplained Phenom-

ena. As an independent investigator Jordan, with a fair amount of skepticism, took photographs of mutilations to four separate psychics, each with a well established reputation for accuracy. He was amazed by their independent analyses which showed a stunning similarity of impressions, each describing a military or paramilitary operation involving helicopters, sharp surgical instruments, the necessity for fresh animal samples, *hovering craft with lights to give the impression of UFOs*, and a strictly terrestrial but massive covert operation. In one way or another each of the four psychics insisted that "phenomena suggestive of extraterrestrial involvement had been introduced to create confusion."

So we have two diametrically opposed stories — UFOs manned by "advanced" aliens cloaking themselves as helicopters — or — military helicopters cleverly disguised as UFOs.

What would you believe?

WHO CONTROLS THE CONTROLLERS?

While Pontolillo and Cannon present enough evidence between them from a psychoanalytical and physical standpoint to deflate the gray alien bubble, there still remains a nagging feeling that something strange is going on.

Deep within the ancestral memory of every race lies the tradition of space contact, of communication with divine or other-worldly beings and it seems that at certain times, perhaps during powerful planetary alignments, the barriers which separate humans from other worlds and states of being become more tenuous, more easily crossed. During the 1960s and '70s for example an intense occult revival began to surface across the planet inspiring individuals and groups to alter their modes of perception, to penetrate other dimensions and extraterrestrial spaces and make contact with 'those beyond.' Occult technologies for accelerated spiritual development became suddenly available and so did a strong desire for freedom from the prevailing and intensifying state of global materialism.

It was also during this time that the alien abductors made their first much publicized appearance. Was it a deliberate attempt to close down the newly opened 'doors of perception' — to make people fearful of something beyond the control of earthly powers? Or was it merely coincidence?

One of the major influences on this occult revival were the prolific writings of the English magician Aleister Crowley, who was instrumental in merging the occult knowledge of the orient with the western mystery tradition, and who could be called one of the first contactees — in particular a book transmitted by a 'trans-mundane' intelligence called Aiwass in Cairo in 1904. Several years later in America Crowley made contact with another extraterrestrial entity called Lam and the reason I mention this is because a portrait drawn by Crowley of this entity bears a startling resemblance to the modern 'gray alien.' In recent years others have also made contact with this entity which is regarded by the respected occultist and contemporary author

Kenneth Grant, as a potent "Gateway to other dimensions, other worlds or aethyrs." And, he says, this image of Lam (reproduced below) is "fast becoming a focus for those interested in the occult implications of 'Ufology' and intradimensional psionics."

From *The Magical Revival* (1972) to *Hecate's Fountain*, his latest work, Grant has explored the occult ramifications of extraterrestrial contact throughout human history, through "dimensions that scientists are only just beginning to explore." He identifies the 'gateways' through which alien forms of consciousness are manifesting and the reasons why a rapidly growing number of people are experiencing an explosion of consciousness, felt as disturbing because most are without any occult, metaphysical or scientific discipline.

Through the manipulation of natural forces such as nuclear and electrical technologies man has unleashed certain energies (or from an occult point of view, has invoked certain entities) over which he has lost control and is now totally unprepared to face the consequences. The elemental constituents of the material world have been blown apart, the 'gateways' have been opened once again between the worlds and real contacts are being established between the inner consciousness of evolving humans and outer, or inner, space intelligences. For those who can't detach themselves from a materialistic world view these subtle contacts are translated in material terms as physical beings, 'the grays' with their equally solid space ships (of which no material evidence exists), rather than being recognized as grossly deformed shadows reflected into the subconscious from cosmic individualities beyond the ken of the rational mind.

It's obvious that our world is undergoing a violent transformation. All concepts of what constitutes a stable universe are daily being swept away. Who can say with all certainty what is real, or what is not? As for the 'grays', the only ones I've seen with sinister intent are

the gray faced, gray-suited politicians on the network news deciding *your* fate. As to whether they're human or not — well, that's another story...

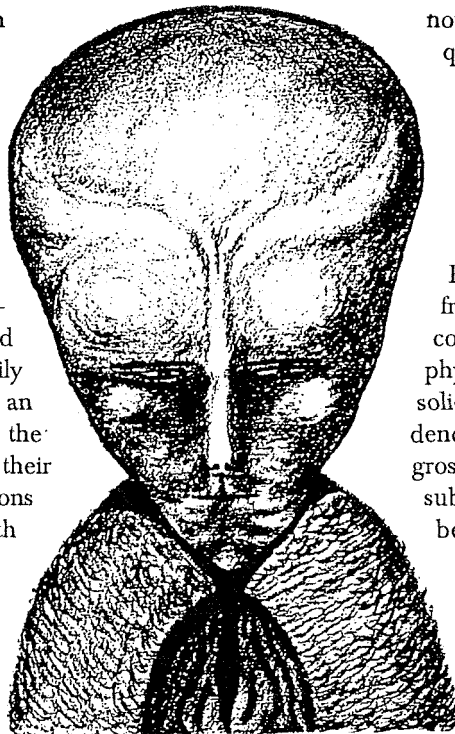

References

- Demons, Doctors, and Aliens* by James Pontolillo, International Fortean Organization, Arlington, Virginia, 1993
- The Controllers - A New Hypothesis of Alien Abductions* by Martin Cannon - condensed in MUFON UFO Journal October 1990, and November 1990., 103 Oldtowne Road, Seguin, Texas 78155-4099
- The Psychometry of Cattle Mutilation: Four Psychics and Their Readings.* by Peter A. Jordan - from *Fortean Times*
- UFOs And The Alien Presence* edited by Michael Lindemann, The 2020 Group, Santa Barbara, California, 1991
- FATE* magazine, Vol. 45, No. 9. September 1992
- Hecate's Fountain* by Kenneth Grant, Skoob Books Pub., 11a-17 Sicialian Avenue, Southampton Row, London WC1A 2QH, 1992
- Picture of Lam from *Equinox*, Vol 3, No 2, edited by A. Crowley.

DESIGN ECOLOGY III

Practical Applications In Synergetics

by Michael Riversong

Buckminster Fuller's reconstruction of geometry is incomprehensible to many. However, it has serious practical applications which can be uncovered by diligent attention to his work. Nobody should ever attempt to read either of the Synergetics books straight through from cover to cover. These books, in themselves, are a synergetic structure and in fact it is best to have both volumes, rather than just the one that's easy enough to find. **Synergetics Two** is almost impossible to find, but the search will be well worth it for the serious student, because the second volume explains many problems and difficult spots in the first book. In addition, the newly released **Cosmography** book goes a long way toward simplifying some of the concepts presented in the Synergetics material.

The best way to read these books is to thoroughly study the chapter headings and section guides in the front of each book. With those in mind, one can pursue lines of thought weaving throughout the book in a perfect geodesic pattern. This makes the study intensely personal, which is the way all study should be anyway. The idea that there is information beyond basic reading and simple math which must always be learned by rote is destructive and has no place in the process of creating a livable world. The first thing these books do is to completely destroy any pre-existing notions concerning plane geometry and calculus. These old forms are built upon the assumption that things can be conceived of in terms of flat planes and straight lines, when, in fact, neither exist anywhere in the Universe in any observed experience. Fuller flaily stated that we had been using these tools for too long and need to progress beyond them as rapidly as possible. This is the core function of Synergetics, to create a firm mathematical foundation which can be applied to any other science. This was always the function of mathematics in the past. For example, the discoveries of Isaac Newton and Galileo were fundamental to the evolution of civil engineering practice in Europe and America. Now, the discoveries of Synergetics can become fundamental to the evolution of ephemeralization, which is the process of "constantly learning to do more with fewer materials."

STRUCTURAL DESIGN

The most obvious use of Synergetics to date has been in the process of designing more efficient structures. The geodesic dome is the most well-known example. It is through Synergetics that the structural design of these domes was developed, because angles of the supports became easy to calculate. Geodesic domes use a minimum amount of materials to enclose a maximum amount of space. Thus they have become widely used in military

applications. Applications for shelter have been a little more difficult to develop due to the fact that the many faceted surface of geodesic domes is difficult to seal from the elements. Once that problem is surmounted, we may find residential geodesic domes becoming much more common.

Another type of shelter inspired by Synergetics is now being promoted by Will and Cathy Sawyer in Maui, Hawaii. This shelter makes use of a single star coupling at the top of the structure from which radiate five supports. These five supports serve as a place to drape any kind of covering, be it plywood, plastic, canvas or salvage material. Simple triangular supports terminating at the upper radiating beams complete the structure and form stable walls. According to the Sawyers, this type of structure uses one-fifth of the materials that a conventional box house uses to enclose the same amount of space. One can be erected in less than a day. A similar concept has been seen in photographs of a campground in Central Europe.

Existing structures can be surveyed and, sometimes, optimized using Synergetic principles. The ideal angles postulated in Synergetics can be applied to an understanding of the harmonics of any structure. Once one gets used to thinking in terms of "in and out" rather than "up and down", we find that structures can even be used to enhance the intelligence of inhabitants. By understanding the mathematical process, remodeling recommendations can be made simpler and less expensive. For example, it can become possible to observe stress lines in a building and, without benefit of complicated engineering equations, instantly comprehend the optimum path for supplemental support. Through Synergetics, this can become an automatic mental process.

GEOBIOLOGY

People who live in conflict with geobiological patterns are more likely to suffer from certain illnesses, including cancer. This is according to statistical research done in Germany, Austria and France over the past 100 years. Synergetics may be the key to unlocking the secrets of Geobiology. Therefore, we may find a prevention for cancer within the mathematical process of Synergetics!

At a certain wavelength of light, Russian satellites discovered a subtle pattern of lines extending all across the globe in a pattern very much like many of the illustrations in the later parts of the Synergetics books. These are some sort of structural manifestation, but we can't determine the exact nature of the structure at this point. It may be composed of energy waves corresponding to what the Chinese would call Ch'i power. According to the Chinese, this mysterious Ch'i power holds the entire Universe

together. These large grid lines have been seen criss-crossing the entire globe, and often converge near places of sacred significance according to native traditions. The practical application of these lines has been a bit unclear. However, in ancient geobiological practice, sometimes known as Geomancy, there were ways to detect what are known as "ley lines" running throughout the countryside. People could locate alongside of these lines and gain prosperity and good fortune. If they were to locate directly on top of a line, they would purportedly become ill and disturbed. Unfortunately, wide variations in technique and ability among those who know anything about ancient geobiological practices make it difficult to verify the locations of these lines today and consistently map them. Dowsing is the only tool available at the moment, and it has proven to be notoriously inaccurate. It is also possible that power lines, highways, and fence lines may have had some effect on the natural flows of invisible energy throughout the Earth as well. By using thought processes as shown in the Synergetics material, it may be possible to plot the probable location of natural ley lines, and then attempt to use observers, gravity wave detectors, scintillation counters, and magnetic detectors to pin down the exact locations of these lines. This will go a long way towards easing the confusion that researchers are currently feeling in these matters.

TRANSPORTATION

Complete redesign of our transportation systems is essential if we are to prosper as a species. Many of the world's most serious pollution problems stem from the support of our current predominant method of transportation on this planet, which involves fossil fuel, and internal combustion or turbine engines. These engines create pollution, are expensive to manufacture, use tremendous amounts of natural resources, which then often become wasted, and are still slow, inefficient and dangerous. According to some of the postulants of Synergetics, there is an abundance of natural energy existing as structural wave forms throughout the Universe. It is possible to find a way to hook into these energy patterns and use them for new and, as yet, undreamed of transportation methods. Several of the legends that focus on the ancient Atlantean culture give another intriguing clue as to the nature of a possible transportation system. According to these legends, Atlanteans had built up a system of control crystals, which amplified certain aspects of the natural grid lines of the Earth, and allowed relatively simple electronic devices to tune into these lines of force and create a harmonic condition resulting in levitation of small vehicles. Whether or not these legends are true is open to great debate, but interestingly enough, Synergetics at least offers the possibility that such a transportation system could be developed. This is due to the fact that the structural, invisible lines of force that hold together any kind of astronomical body must contain some energy. There is no way around that. If one could tune into that energy somehow, then remarkable developments in this field would suddenly materialize. By putting this idea into print, it is hoped that experimenters will delve into Fuller's methods of thinking, which should expand the frontiers of methodology and create these new transportation systems so desperately needed in our world today.

ENVIRONMENTAL REPAIR

The past five generations of humans on this planet have inflicted increasing amounts of environmental damage on landscapes and other species. Of course, this must stop and it will stop one way or another. It may stop with the sudden extinction of our species because of our planet's refusal to support us anymore. Or it may stop because we consciously choose to think in different ways, allowing us to stop doing any further damage and begin the difficult processes necessary to repair what we can. We are already witnessing remarkable developments in chemistry and physics, based on Synergetic forms. As we move deeper into these concepts, we will discover that all chemical elements are simply harmonic patterns held together by invisible structures which have an underlying consistency. The whole confusing system of quarks, muons, and mesons, and other strange transient subatomic particles, will no longer be necessary in attempting explanations of what is going on. Instead, we will be able to speak of elements and chemical compounds as harmonics resonant at certain frequencies. As we begin to understand the synergetic interactions between gravity, electromagnetism, g-force, and the harmonics of elements, we'll be able to learn how to transmute elements, and thus detoxify some of the worst pollution sites. Of course, this is tricky business and it is going to take a great leap in understanding from where we are.

METEOROLOGY

Storms track along grid lines that are spontaneously developed. Once we learn how to detect different kinds of grid lines that form and reform constantly, we'll be able to know in advance where a storm is going to track. These grids are simple in synergetic terms. Since there are invisible forces that pull the storms along, they should always be easy to map. We can then find the grid lines where storm tracks are anticipated several days in advance, and thus obtain warnings of floods, tornados, and hail.

CONCLUSION

Design Ecology is a new discipline, which has pulled in a number of other disciplines in its scope. Each practitioner must make a personal choice regarding which parts are most important to pursue, depending on the needs of clients and one's own talents and abilities. Still, when not engaged in the study of any other matter, it would always be best for consultants to immerse ourselves in the Synergetics material. As we do that, we will improve our navigational abilities, enhance our creativity, and begin to understand a common mathematical language which describes the structure of our Universe. This understanding can easily be put to use for the benefit of our clients, as we grow in our own abilities.

Michael Riversong, QI CONSULTING
Box 36387, Lakewood, Colorado 80236 (303)829-0774

BUCKMINSTER FULLER INSTITUTE
1743 S. La Cienega Blvd.
Los Angeles, California 90035

La Science et le Bonheur

LONGEVITE ET IMMORTALITE PAR LES VIBRATIONS
(Science and Health, Longevity & Immortality through Vibrations)
and

La Terre et Nous

(The Earth and Ourselves)
both by Georges Lakhovsky

INTRODUCTION

When reading both of these works for review, I thought it would be better for BSRF's readership to "group" the subjects broached in both and to include in every grouping what Lakhovsky says, with my comments added. This was done to avoid including, as he does, plenty of anecdotes and tales irrelevant to the analysis and study of his theories and actions. For the sake of completeness, I now detail his written works up to 1933 minus his scientific papers as published in French scientific journals:

- 1) L'origine de la Vie (Origins of Life), Gauthier-Villars Editors, Paris, 1926.
- 2) Contribution a l'Étiologie du Cancer (Contribution to Cancer Etiology), Gauthier-Villars Editor, Paris, 1927.
- 3) Universion ('Universion' is Lakhovsky's term for the Ether), Gauthier Villars, Paris, 1927.
- 4) Le Secret de la Vie (Secret of Life, actually it is (1) with some added chapters and more information), Gauthier-Villars, Paris, 1929.
- 5) La Science et le Bonheur (Science and Good Health), Gauthier-Villars Editors, Paris, 1930.
- 6) L'Oscillation Cellulaire (Cellular Oscillation, a collection of experimental researches according to the source in (9)), G. Doin et Cie, Paris, 1931.
- 7) La Formation Neoplasique et le Desequilibre Oscillatoire Cellulaire (Neoplastic Formation and the Cellular Oscillatory Unbalance), G. Doin et Cie, Paris, 1932.
- 8) L'Éternite, la Vie et la Mort (Eternity, Life and Death), Fasquelle Editors, Paris, 1932.
- 9) La Terre et Nous (The Earth and Us), Fasquelle Editors, Paris, 1933.

From these I have read the Spanish translation to (4), published in 1929 by Aguilar, Madrid, Spain, and works (5) and (9).

THE "UNIVERSION" AND OSCILLATIONS

"Universion" was the name given by Georges Lakhovsky to what us Borderlanders call "The Ether", meaning an all-space filling force capable of producing, when properly excited and manipulated, all kinds of effects. To Lakhovsky the Ether was not motionless but full of many different oscillations of electromagnetic character. And when he stated this, he meant of Hertzian-type oscillations. In his view these oscillations happened within the Ether, and NOT as it is meant today within "empty space" as dictated by Relativity Theory.

Please notice that what I am reviewing are Lakhovsky's ideas as told in his publicly available written works. If he had a personal and secret viewpoint, I do not know so, wherever deemed necessary, I will insert the proper comments related to BSRF

literature and findings. Considering that Hertzian-type oscillations were the only ones that could be produced in the Ether, Lakhovsky began to research in earnest correspondences between living organisms and the current (1920/1930) oscillation-producing equipment:

For example, he likened the twisted filament within a cell (see Figure 1) with the self-inductance or coil in a radio transmitter/receiver, he also did the same with filaments within micro-organisms such as the 'Corynactis viridis' (with a current size of 0.1 millimeter, and living in the sea), as shown in Figure 2.

But, to Georges Lakhovsky, the filaments were not the only oscillating members within a living organism. As seen in Figure 3, within a cell also exist Chromosomes and Chondriomes:

Both elements, Chromosomes and Chondriomes, he likened with capacitors as is seen in Figure 4.

Each of the elements within a cell oscillated in a particular manner, according to Georges Lakhovsky, so that the combined oscillations produced the well-being of the cell and all cells vibrating harmoniously generated the well-being of the whole body.

In continuing with his viewpoint (5), Lakhovsky likens the "a-b" cellular axis, as shown in Figure 5 with the "North-South" ferromagnetic axis (same illustration). The cell's internal filaments (see I in Figure 5) he equals with a coil of wire wound around the magnetic axis (see (II), same illustration).

As seen in Figure 6, over these lines, he likens the homoeotypical process of cell-division ("according to

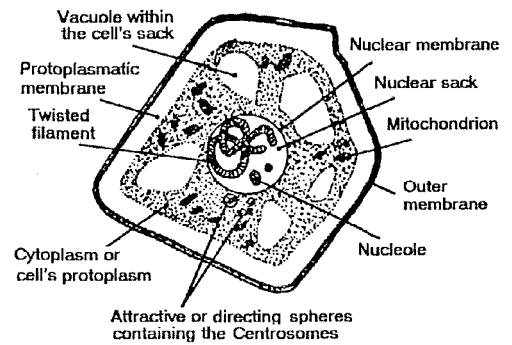

Figure 1

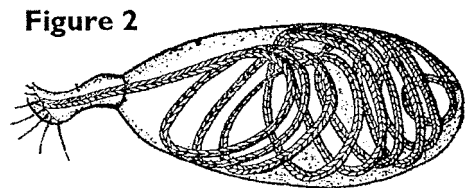

Figure 2

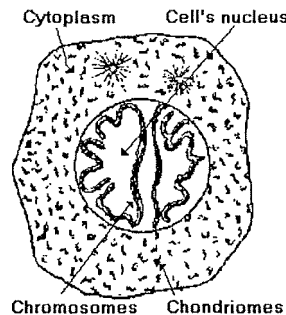

Figure 3

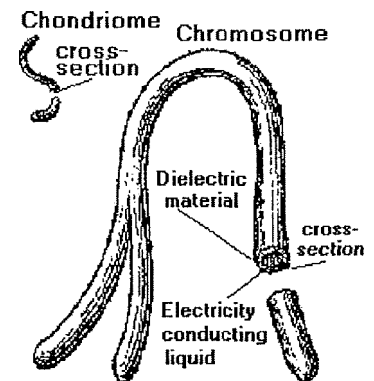

Figure 4

Flemming”, he says (5), but I searched in vain for a referenced Bibliography by adding letters “N”, “S” and the signs “+” and “-”, to indicate both electrical and magnetic polarity.

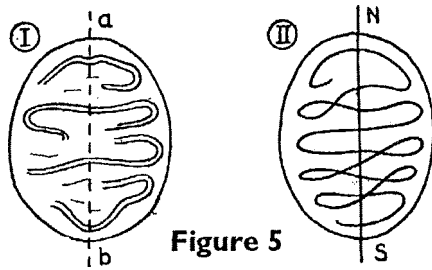

Figure 5

In Figure 7 he illustrated the heterotypical process of cell-division, again following the dictum of Flemming and adding also letters for magnetic and electrical polarity:

From one Mr Henneguy (also, unreferenced) he takes illustration of germ-reproduction.

In Figure 8, over these lines, we see: at (I) the actual physical events as depicted by Henneguy and at (II) Lakhovsky’s view with electrical polarities added. One pertinent remark here: “NEGATIVE Polarity” was for the early electricians the “electricity-absorbing pole” — as they then considered electricity as a fluid with given properties. In the same fashion, “POSITIVE Polarity” meant the “electricity

issuing pole”. Throughout his two works — (5) and (9) — Lakhovsky employed these two concepts as I explain in this paragraph. As you must have noticed, the cellular processes of the last three illustrations employ

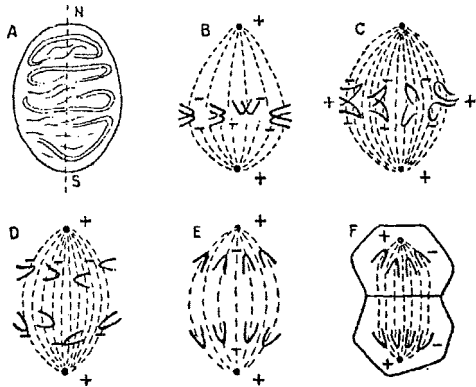
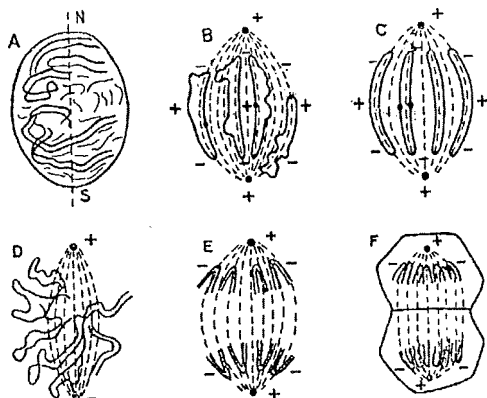

Figure 6

three different types of non-uniform fields to happen; remember this fact later.

Whenever a given oscillatory imbalance occurred in the body, according to Lakhovsky, normal healthy cells first died and later they began to transform into cancerous cells to later form

Figure 7



tissues of this very kind, as illustrated in Figure 9.

This given oscillatory imbalance destroyed most of the cell’s internal constituents and hardened its membrane, first; to gener-

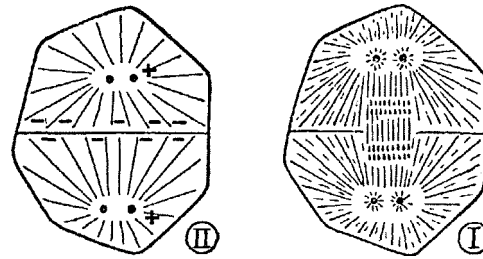

Figure 8

wildly, without any restriction, and thus cancer spread itself throughout the body. How the imbalance was created, and Lakhovsky’s solution to it, will be seen in coming points to this review. One note of caution, however: What is written in both

works happened over 60 years ago, our environmental conditions have changed since then. So, whosoever attempts to do anything concrete with Lakhovsky’s findings will have to ADAPT his/her efforts to these

changes. Please do not forget this important point!

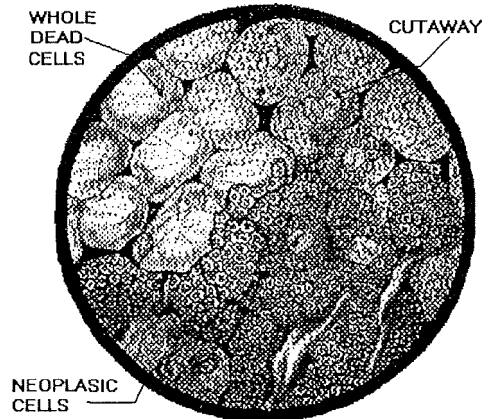
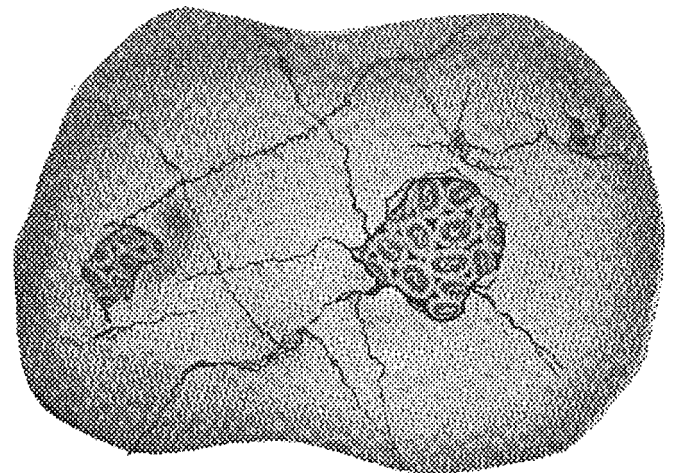

Figure 9

DIFFERENT POLARITIES IN THE SOIL

One of Lakhovsky’s most interesting findings is that the different strata and groupings of localized character of the same soil-constituents do have electrical polarities. Soils of “Negative Polarity” absorbed and conducted the etheric waves coming to Earth from the Cosmic space into deeper rock-strata; by opposi-

Figure 10



tion, soils of "Positive Polarity" reflected, refracted or changed these waves before these waves were sent somewhere else because of other wave-trains coming behind.

Both kinds of soil, according to Lakhovsky, affected human health differently and these are the main representatives for each class:

Negative Polarity

Positive Polarity

- | | |
|--|---------------------------|
| (-) Sand and sandstone | (+) Plastic Clay |
| (-) Thick-calcareous | (+) Gypsum loam |
| (-) Gypsum (un-alloyed) | (+) Saint-Ouen calcareous |
| (-) Recent alluvial deposits
<i>rich in freshly-broken
small rocks and sand</i> | (+) Green marl |
| | (+) Phosphorous chalk |
| | (+) Iron minerals |

Now, very strange effects happen where two different kinds of soil meet — at frontiers called "faulty-lines" by Lakhovsky. Let us see each effect separately:

As shown in Figure 11, over these lines, each kind of soil imparts its own electrical polarity to storm-clouds above. Lakhovsky says lightning strikes the ground only in the faulty-lines because each different type of soil is like a plate of a massive electrical condenser charged with one kind of electricity until it discharges at the "breaking level". He carries the idea even further, as illustrated in Figure 12, by indicating that massive amounts of electricity could be obtained from underground strata by sinking deeply into the ground metallic shafts of the right metals and tap said electrical charges accordingly. Cities, towns, trains, etc., could be electrified cheaply and permanently by these means he states.

What he says of the storm-clouds' electrification, I have read nowhere else; I only found some complementary data in "The Earth's Electricity" by the late Dr. James McDonald of UFO-research fame (see the April 1953 issue of "Scientific American").

About tapping the Earth's underground electrical fields in this manner, I found at no other place what he states of the different soils possessing opposite electrical charges. Yes, I am acquainted with Nathan Stubblefield's "Earth Battery" but, so far, nothing as definite as Lakhovsky indicates. *Please, should someone possess more info, write to Borderland Science, forwarding it.*

From this conception, Lakhovsky originated his view of why Volcanism exists, he states where two different geological formations meet each other and produce a massive electrical sparking that, in turn, fuses and vaporizes the underground rocks to later expel the—in this state—upwards, where they cool and form the usual volcanic cone, as seen in Figure 13. The way and extent with which this viewpoint complements itself with what has been postulated (and mathematically backed, so that anyone with the proper knowledge and calculating-means can duplicate it) by Bruce L. Cathie is not known to me. Cathie has not extended his

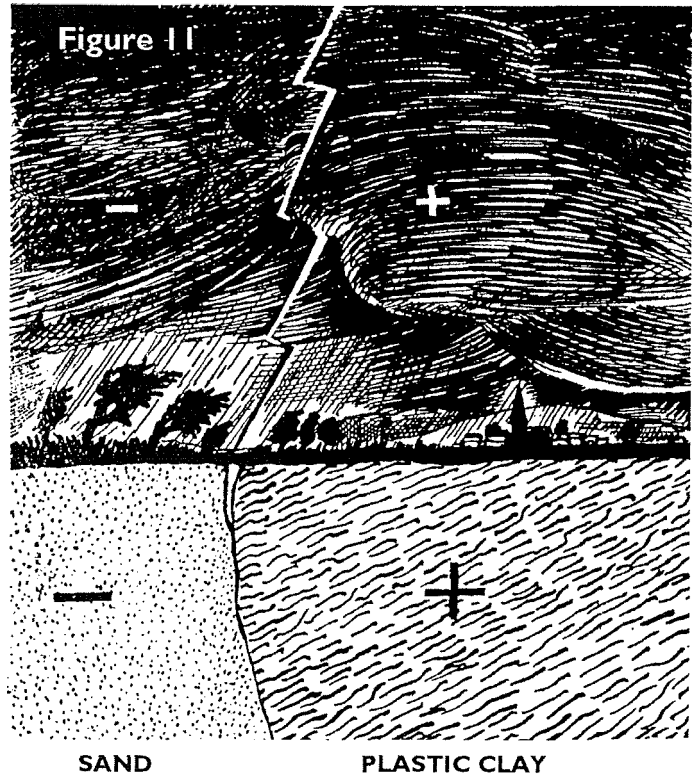

research into the analysis of soils and rock-strata to make it fit his grid-theory (I have not yet done so in my work either).

The faulty-lines do affect human health; for example, should someone sleep as seen in Figure 14, over a line of these, the individual would develop a cancer of the stomach. Not only the faulty-lines produced cancer, according to Lakhovsky, who also states that living in Positive Polarity-type of soils does, together with other diseases coming from being bombarded with reflected and self-interfering radiation.

If, as shown at (A) in Figure 15, your bed is on the path of a faulty-line, one way to contribute improving your condition is to move it into a zone — (B) — which the line traverses not.

In case you live upon a Positive Polarity-type of soil, you can get sick from the environmental reflected radiations but you can reduce the risk of getting sick by "polarizing" yourself like the ground you live over. Lakhovsky mentions that the inhabitants of Memphis, just to name a case, drilled a deep well to get water for drinking and that this water was positively-polarized; drinking the liquid, Lakhovsky states, effectively immunized them against any soil-produced disease.

Lakhovsky recommended living upon Negative Polarity-type of soil, such as deserts or similar zones, for the continued conduction of incoming energy guaranteed it would not accumulate in the body. He mentions, to this effect, that the healthiest portions of Paris were those built upon this kind of soil. Yet, one wonders, the extent to which this generalizing statement is correct nowadays with all the many changes which have happened...

Finally, he postulates that the tides are not due to "rising and lowering of the waters" but of the ground by them! This we see illustrated at Figure 16. Lakhovsky considered as "invariable" the level of water, while thinking that the different radiations — mostly, solar ones — falling upon the ground (and penetrating, or

Figure 12

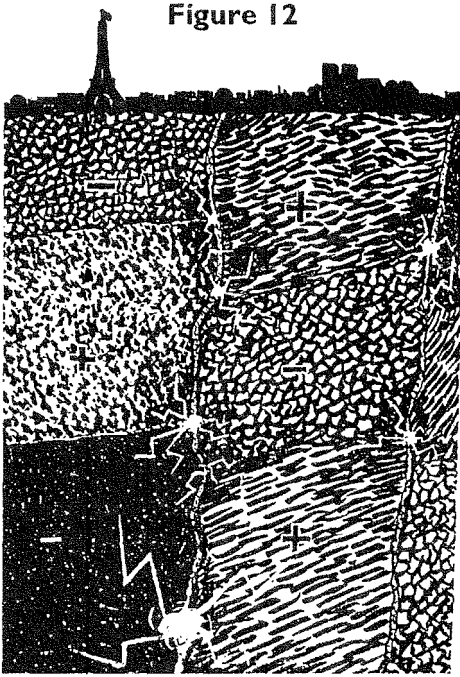

not, within — to different degrees, according to the ground's constitution) made it rise or lower. In this manner, he explains the different heights reached by the waters at different coastal locations.

Has anyone in the readership more data concerning this conception? Please let us know.

THE LAKHOVSKY MULTI-WAVE OSCILLATOR

I will refrain here from analyzing what Lakhovsky says about his "Radio Cel-

Figure 14

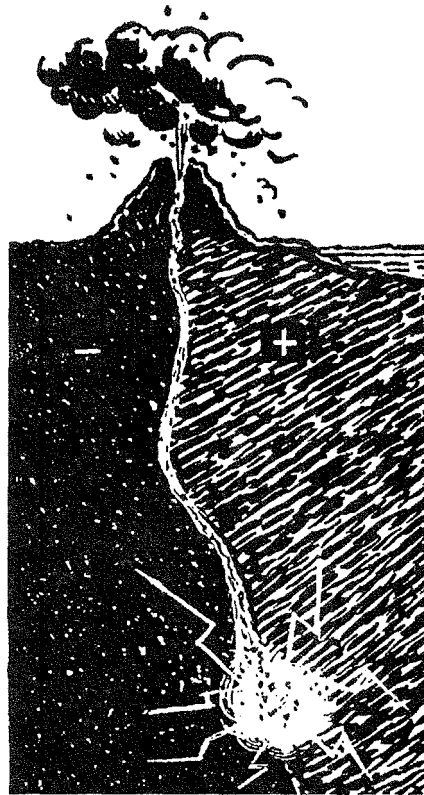
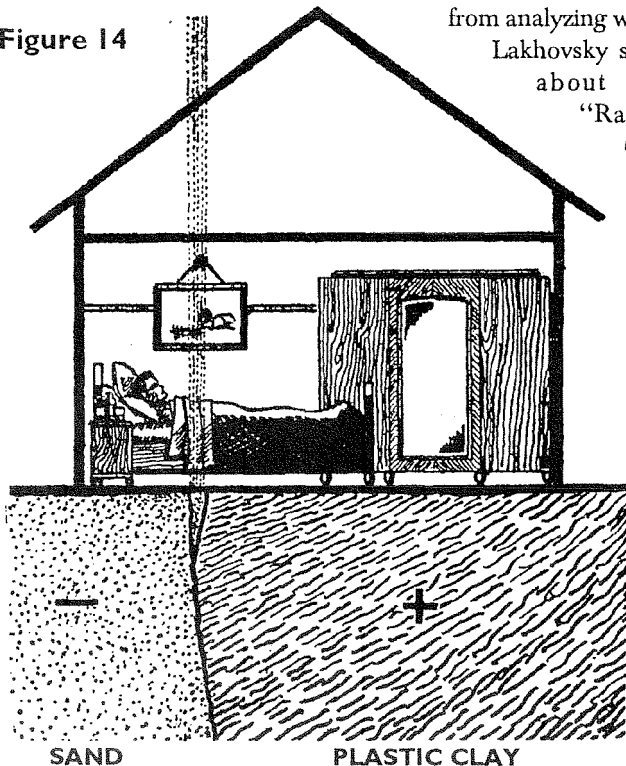

Figure 13

ular Oscillator", for this is included in "The MWO Handbook" (1992 edition by BSRF). The data included in this section is taken from both reviewed works (5), (9), and even so I think it is too small to "break" into Lakhovsky's way of thinking and the resulting experimentation he must have performed.

In Figure 17, we have the following type of Hertzian oscillators: (I) Open Hertz-resonator, (II) Hertz-resonator closed by a capacity, (III) Hertzian dipole and (IV) Setup of dipole with a coupled oscillating circuit. Throughout both books (5), (9), Lakhovsky never talks about any other kind of oscillator that is not Hertz-based. Lakhovsky employed a "proportional antenna", whose elements were concentric cylindrical metallic tubes ending in spheres. The way he established the proportion in-between different metallic tubes is illustrated in Figure 18.

From a given length "l", the basic wavelength in his device, he first established a radius "r" (by dividing "l" by "Pi") that he multiplied by a constant

"a". You see at (I), of Figure 18, the wavelength "l" when in a Hertzian dipole and at (II) when in Lakhovsky's metallic tubes ending in spheres. Yet, in none of the books reviewed is it indicated WHICH are the numerical values under consideration and WHY these specific values are employed. A "thunderous silence" is found when looking for them....

The only information Lakhovsky furnishes us with is that he generated "many different waves, from 10 centimeters to 400 meters" by using the fundamental wave, its harmonics and the interferences (with other waves) that are produced in the process. The reason behind this idea, he states is that "We know in Physics

Figure 15

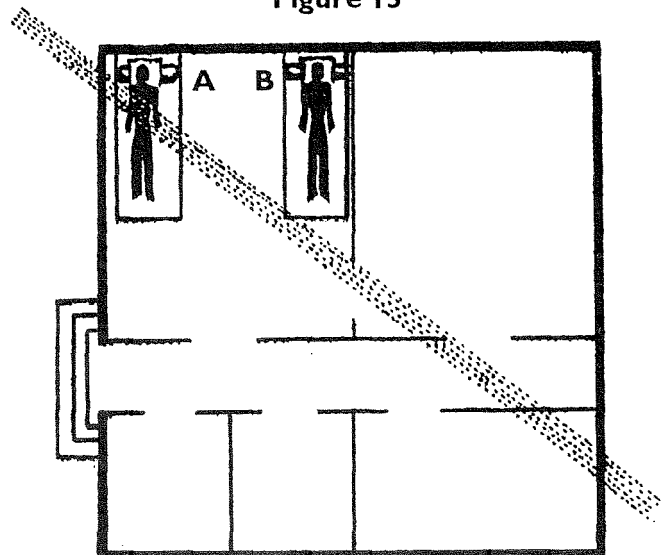

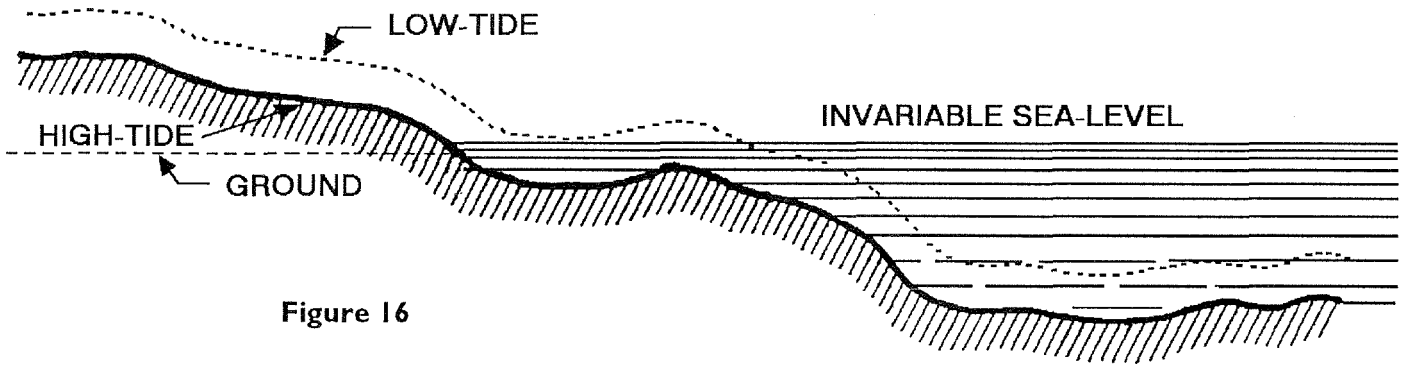

Figure 16

that a circuit fed by high-frequency damped currents creates many harmonics" (from pages 147-148 of (9)).

These many different wavelengths would be selectively

19 the rings are ABOVE the tubes and in Clement's book they are BENEATH—why?—unless this is purely a mechanical concern.

b) I assume that the thick cylinder at the foot of the right-unit, (Figure 19) contained the original electronic equipment needed

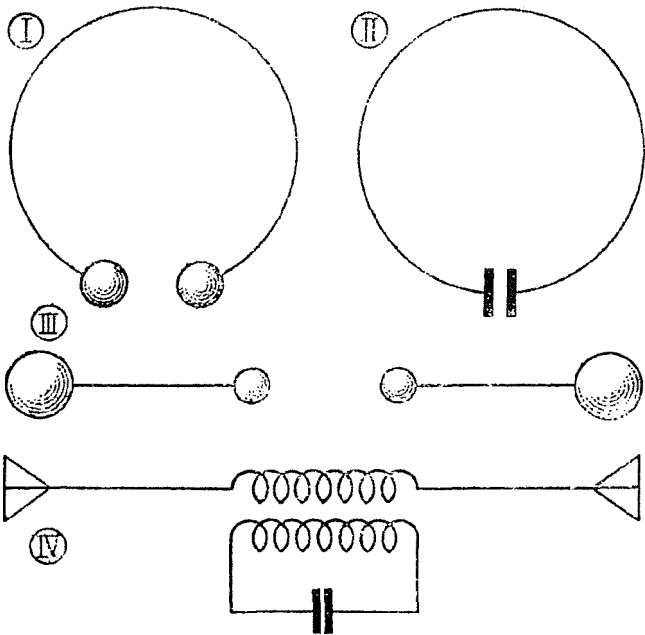

Figure 17

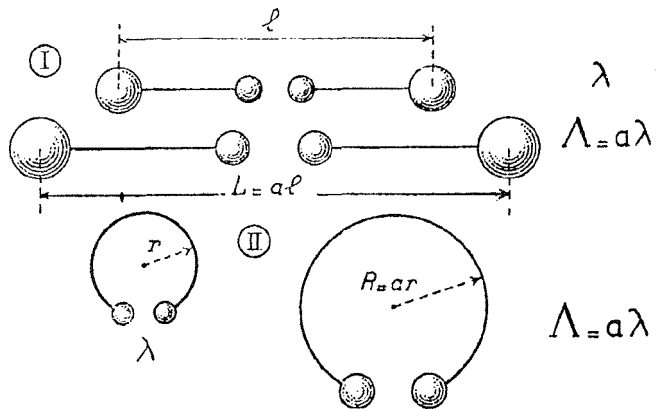

Figure 18

to make the machine work. Compare with the photo on page 29 of Clement's book and you will see the volume involved is tripled (or closely). What changes were made and WHY???

To end this two-book review, I would like to ask anyone possessing a copy of the referenced Lakhovsky works to send a duplicate to BSRF to see how much can be cleared of both the M.W.O. and any other research by Georges Lakhovsky.

absorbed by the cells and tissues in our body lacking in the proper wavelengths to maintain the proper oscillatory balance; this would be done, he states, because cells can act both as emitters and receivers of waves.

By February 1931, the first Multi-Wave Oscillator was finally built and was in working condition and in July 1931 it was tested at the Saint-Louis Hospital, with success.

This first model is seen in Figure 19, and it is taken from page 135 of (9) with the following explanation beneath the photo: "Multiple-Waves Oscillator. Lakhovsky device complete with its two resonators (that) create an electromagnetic field in-between its two elements".

In short, the two sets of concentric rings are the "resonators" to create the in-between field. This model is a far cry from the more elaborate one shown by Mark Clement in his "The Waves That Heal". Only a few features remain:

a) The thick tubes holding the set of rings; yet in this Figure

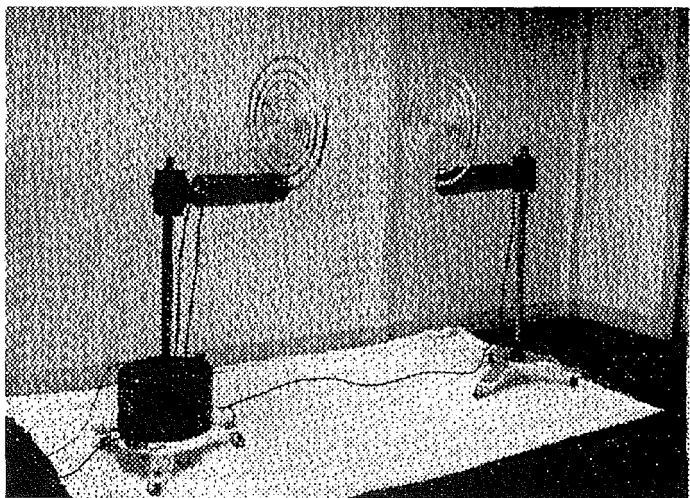

Figure 19

The current quest for acceptable and, hopefully, desirable battery powered electric vehicles to replace the fossil fuel powered smog producers characterizing current civilization seems to ignore options predicated on the past. The quixotic, confused, irrational and emotional drive of the ecologically "politically correct" individuals behind this quest is quite forceful. Its momentum is directed toward battery power to such an extent that in unconventional thinking as to alternative vehicle constructions seems to be excluded from consideration.

The apparent present significant lack of serious consideration of Stirling and related externally heated engines as replacements for common internal combustion engines illustrates this point. Stirling type engines as we know them today are operated using an external heat source such as a hydrocarbon

drawback. When burned they produce the usual products of low pressure combustion — including carbon dioxide.

While carbon dioxide is a valuable compound which is vital to plant growth the amount of it currently in the air is at least a major cause of the earth's atmospheric deterioration. Any replacement for internal combustion vehicular power contributing to the glut of this gas is not desirable. To some it will seem that this alone should block the utilization of conventionally operated Stirling type engines and invigorate the quest for battery powered vehicles. Not so.

Roughly the same amount of hydrocarbon fuel will be required to generate the electricity to charge batteries to operate a battery powered vehicle in a specific manner as will be required to directly heat a Stirling type engine to operate approximately the same vehicle in the same manner. In addi-

drive a Stirling type engine has obvious limitations. The sun cannot be manipulated to provide heat in the middle of a rain storm and definitely cannot directly provide heat to operate such an engine in the middle of the night. The use of hydrocarbon fuels as an energy source by either burning or catalytic oxidization is limited by the availability and cost of such fuels.

Unfortunately the earth's supply of fossil fuels is finite. There is only so much area on the earth available for being used to grow plants desirable for direct use as a hydrocarbon fuel or for producing seeds, sap or the like useful as such a fuel. Because of these limitations from a long term standpoint it is just as bad to contemplate hydrocarbons as the source of fuel for Stirling type engines as it is to contemplate vehicular batteries being charged with electricity. As a practical matter most of the power needed to produce and

Another Possible Alternative To Battery Powered Vehicles

© 1993 by Ed O'Brian

fuel burner to heat a gas within the engine so that mechanical power is produced as another part of the engine is cooled. They are usually considered as long known, obviously operative curiosities which for one reason or another really can't make it in the current commercial world.

Those familiar with Stirling type engines recognize that they have a significant virtue. As commonly operated they differ from internal combustion engines in that the hydrocarbon fuel normally used with them is not formed into a confined explosive mixture with air but instead is burned at a relatively low temperature and at atmospheric pressure. This has the benefit of avoiding or nearly avoiding the production of undesirable smog contributing nitrogen oxides characteristic of internal combustion engine exhaust.

Unfortunately these Stirling type engines are not as wonderful from an ecological standpoint as this would imply. Conventional burners are practically always used with them. Related catalytic oxidizing units can be substituted for these burners. The hydrocarbon fuels normally used with these engines can be from either agricultural or fossil sources. Both suffer from the same

tion, the manufacture of new batteries and the disposal of worn out old ones create energy and ecological obstacles to any possible benefit which might be achieved by using battery power instead of power produced by internal combustion engines.

Consequently there is good reason to believe that from a long term standpoint vehicles powered with current Stirling type engines are at least as desirable from an ecological standpoint as battery powered vehicles. Because Stirling type engines do not have to be recharged over a significant time period while battery powered vehicles require such recharging, those vehicles using Stirling propulsion have a material advantage over those with battery power. Fortunately it appears possible to increase this advantage by modifying the heat source used with a Stirling type engine in what is probably a novel manner.

Such engines are not persnickety as to the origin of the fuels used in their operation. They do not care about the origin of the heat used in their operation. Thus, it has long been recognized that Stirling engines could be operated using virtually any type of fuel or radiation from the sun.

The use of the sun as a source of heat to

charge such batteries will come from existing sources of electricity — primarily fossil fuel powered generating plants.

This would suggest that in the benefit of using Stirling type engines to power vehicles instead of using battery powered vehicles from only a fuel conservation standpoint is debatable and may or may not be a valid improvement depending upon a multitude of technical factors. This would be true except if the meaning of "fuel" is not restricted to hydrocarbons. Stirling type engines do not require such a fuel. They only require a source of heat to operate.

Theoretically it would even be possible to power them using electricity "stored" in batteries to provide such heat. It is doubted if this could be as efficient and desirable as using battery supplied current to operate electric motors. One cannot help but wonder if it might not be practical for at least exhibition purposes to mount both a parabolic solar collector and a coupled Stirling engine on a vehicle demonstrating alternate vehicle operation. While any such direct use of solar energy can be considered as "interesting" it has the usual limitations related to the availability of sunlight.

A better, alternative manner or way of

supplying the heat necessary to operate a Stirling type engine on a vehicle is to use an exothermic reaction other than conventional combustion or other oxidization to provide the heat required. It will be best if the reactants are chosen so that the reaction product or products can be easily regenerated to their original composition using any available, inexpensive "means". Such a "means" would preferably be directly applied energy from the sun but could easily be geothermal or any other source of heat.

A prime obstacle to even the investigation of the use of heat from a non oxidizing exothermic reaction to operate a Stirling type of engine in a vehicle will be the horror many persons have for anything "chemical". Such anti-chemical attitudes are constantly being reinforced by US society. This is easily illustrated by the campaigns against unspecified drugs — chemicals — even though some drugs are responsible for most of the effectiveness of modern medicine, and by the proliferation of warning signs against such things as petroleum products and ethanol.

As a result of these and related self defeating scaring activities many individuals have developed a feeling of distrust or disbelief toward anything "chemical". At least a significant proportion of the population retains a latent concern about anything involving the field of chemistry. Even though in a broad sense everything tangible in this world involves chemistry the fears accompanying such concerns intensify the distrust of anything chemical by unthinking "politically correct" environmentalists. For non oxidizing exothermic power to be acceptable this distrust must at least be muted.

In effect this means that non-oxidizing exothermic heat will be acceptable in place of currently used fuels only if a series of conditions can be satisfied. The reactants employed to produce this heat must be chosen so that significant heat is produced from limited amounts of these compositions. They must also be capable of being easily and conveniently regenerated, preferably by the use of the sun's radiation or by a process requiring very little easily available energy. In addition there must be no significant or insurmountable corrosion problem with either the reactants or the reaction product or products obtained from them. Neither can any of the latter create any significant health or environmental hazard.

The latter is a high hurdle. In one sense virtually everything is or can be considered to create a hazard under at least some circumstances. If in doubt relative to this take a

look at the "rap" sheet or MSDS on a common, generally accepted food or seasoning such a sugar or table salt. Such documents are scary. Unless common sense based on experience is followed it would be easy to conclude from them that one should not eat virtually anything.

By a combination of economic desirability and the recognition that governmentally and ecologically projected fears are usually not fully truthful and/or justified it is probable that unjustified fears — as opposed to well founded fears — about health and environment issues can be at least muted so as to allow the acceptance of "chemical" non-oxidizing exothermic operation of Stirling type engines. If these ill founded concerns can be dispelled or held in abeyance the concept of operating Stirling type engines can be investigated and accepted on purely technical merits.

This article is simply another proposal attempting to raise significant doubt about the wisdom of the current quest for battery powered vehicles. From preliminary facts as discussed it would appear that the energies currently being spent on this quest cannot be expected to be as beneficial to both humanity and the ecology as those promoting it believe.

The remainder of these conditions to the acceptability of non-oxidizing exothermic heat to operate Stirling engines and the vehicles coupled to them can be considered as a single question — which reactant or reactants will be best when all factors relative to such use have been adequately and fairly considered. There is no easy answer to this. One can easily visualize a series of Ph.D. dissertations reciting much computer and actual research in an effort to divine optimum reactants and conditions.

Without such activity it is impossible to conclusively demonstrate the desirability of exothermic reaction heating in connection with Sterling type engine operation. However, it is possible to illustrate how non oxidizing exothermically developed heat can be used for this purpose by considering the possible use of a composition usually discussed in elementary chemical classes — common lime. It is commonly and widely used. No abnormally significant hazards are

associated with it. And it is relatively cheap. Because of the fact that the terminology employed in connection with lime has changed slightly with time and tends to be a bit confusing it is desirable to review it.

Virtually everyone will recall that commercial "lime" — calcined lime or quick lime — usually is not pure calcium oxide or calx but contains minor but significant amounts of magnesium oxide or magnesia and other impurities. This is a result of the product being produced by heating a naturally occurring "lime" or limestone deposit until the calcium and magnesium carbonates in such a deposit are decomposed into the oxides and carbon dioxide.

It is believed that most individuals will recall that adding the oxide mixture considered as "lime" to water results in the production of significant heat as the oxides in the lime become hydrated. For this discussion the precise amount of such heat and the fact that the amount of heat produced will vary depending upon the purity of the lime are both immaterial. Since calcium hydrate is only slightly soluble in water when it is formed in an amount of water in excess of the amount required to form it this hydrate will tend to form particles. Some of the latter will enter into a colloidal dispersion in the water as the remainder settle out.

When a Stirling type engine is operated for vehicular propulsion purposes — or other purposes — the hydration of lime with water can be used as indicated in the accompanying crude, over simplified sketch to operate the engine so that the mechanical power produced can be employed in accordance with established or other practices to operate a vehicle. This operation will require the gradual or periodic addition of lime to water in a reaction vessel or container which is located so as to transfer heat produced by the reaction between the lime and the water from the interior of the container to the engine.

The wall of the engine through which heat has to be transferred in order to operate the engine can be the wall of this container. Probably it will be best to form the vessel of the same material as the engine wall where heat transfer takes place so that it fits tightly against this wall in order to hinder this transfer as little as possible and in order to minimize corrosion problems.

It is possible to contemplate the construction of a vehicle so that a fixed amount of water is initially placed in the container and is used until all or nearly all of it is to form hydrates. In order to achieve continuous

operation it will be preferable to utilize a container and associated parts constructed so that both water and lime are added in accordance with the mechanical power requirements of the vehicle in proportions which will produce a mixture capable of being referred to as a "heavy brine" and so that this brine is continuously drawn off at a rate corresponding to the rate at which the reactants are added.

Both the mechanisms for adding the water and lime and for drawing off this brine are fertile areas for engineering ingenuity within the scope of current technology. Barrel type valves can be used to control the addition of the lime and the water. Other functional equivalents are equally usable. Probably it will be possible to design a container in which the reaction takes place so that the heat given off by hydration will set up conventional currents adequate in the absence of motion-caused agitation to avoid the need for mechanically mixing the contents of the container.

Similarly it is expected that the container will be designed so that the brine produced will tend to settle to a quiescent bottom portion of the container where it — including any precipitate in it — can be drawn off as water and lime are added to the container. Some heat savings can also be achieved using a counter-current heat exchanger to use this brine to preheat the water employed. At the present preliminary stage of the concept of using non-oxidizing exothermic reactions to operate an engine it would be foolish to enter into matters of this type which are within routine skill.

The nature of the brine produced by a non-oxidizing exothermic reaction is a critical factor relative to the possible acceptance or rejection of non-oxidizing exothermic reaction operated Stirling type engines. When lime and water are the reactants this brine can be considered as just being another source of impure calcium oxide. In many instances either a benefit or little if any harm will result from discarding limited amounts of it. From the point of view of avoiding any

disposal complications it would be preferable if this brine could be simply treated so as to recover the lime in order that it can be reused.

Since the dehydration temperature of calcium hydroxide — the predominate component of the brine produced — is 580°C significant heat has to be used to recover the calcium oxide from this hydrate. From the point of view of reducing dependence on hydrocarbon fuels of either fossil or agricultural derivation such fuels should not be used to supply this heat. In effect this leaves only limited options. Although one could get into a discussion as to the use of heat of geothermal origin, electrically produced heat

achieved by using parabolic reflectors and the like to concentrate the sun's radiation to obtain temperatures in excess of 580°C, as a practical matter the complexities of heating at such temperatures probably preclude the use of commercial lime as the prime reactant used to generate heat to operate Stirling type engines.

Never-the-less this discussion of the use of commercial lime for this purpose effectively illustrates the manner in which a variety of non-oxidizing exothermic reactions can be so used. In effect this discussion could be illustrated equally well by referring to other compounds which enter into non-oxidizing exothermic reactions. Although it

is easy to think of a variety of compositions which combine exothermically with water without using oxidization to form hydrates the use of reactants other than water may also be practical.

Further, from a practical standpoint a reversible non-oxidizing exothermic phase change must be considered as or as the equivalent of a non-oxidizing exothermic reaction. To many the latter will automatically suggest Glauber's salt as a composition which should be discussed. The extension of this generalized discussion to cover all such matters would convert it from a preliminary proposal into a summary of an investigation.

This is not the purpose of this article. It is simply another proposal attempting to raise significant doubt about the wisdom of the current quest for battery powered vehicles. From preliminary

facts as discussed in the preceding it would appear that the energies currently being spent on this quest cannot be expected to be as beneficial to both humanity and the ecology as those promoting it believe. From these inconclusive acts it is also believed that the effort now being directed to the development of battery powered vehicles should be redirected to the use of nonoxidizing exothermic reactions to operate Stirling type engines as a source of mechanical power for either such vehicles or other purposes.

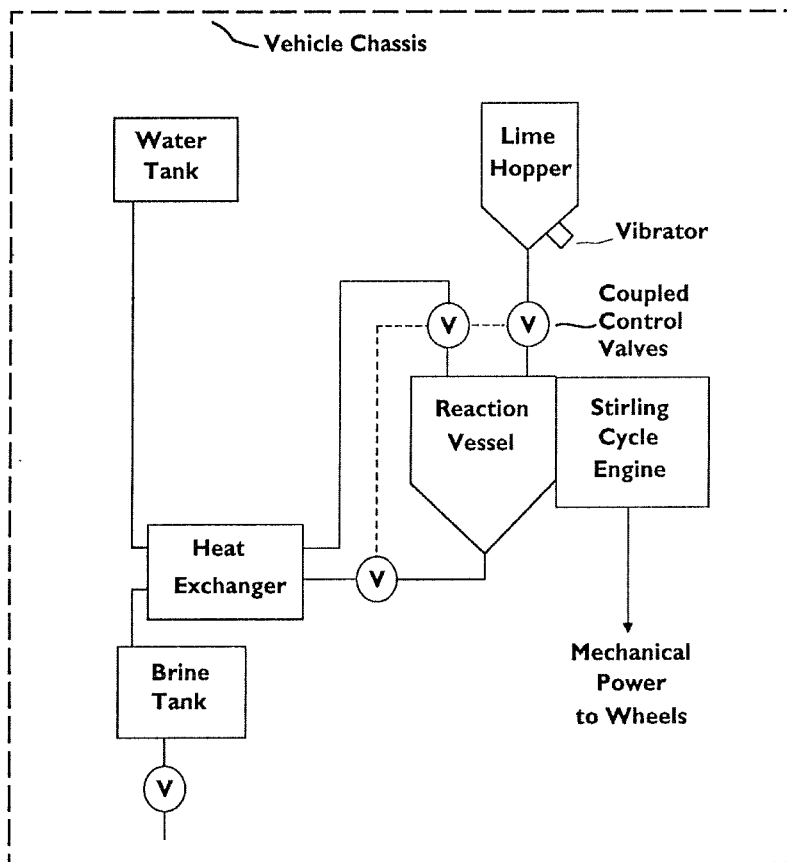

and the like, by far the most significant easily available heat source which should be considered for this purpose is the sun.

While it is to be hoped that further investigation will result in knowledge of, and perhaps the development of, reactants which are not only capable of producing significant heat but which can be regenerated by simply being spread out on a shallow tank or tray. The moderately high decomposition temperature of calcium hydroxide precludes it from being reclaimed in this manner. Even though the necessary temperature can be

EXPLORATIONS IN GRAND CANYON

Mysteries of Immense Rich Cavern Being Brought to Light Remarkable Finds Indicate Ancient People Migrated From Orient

The latest news of the progress of the explorations of what is now regarded by scientists as not only the oldest archaeological discovery in the United States, but one of the most valuable in the world, which was mentioned some time ago in the *Gazette*, was brought to the city by G. E. Kinkaid, the explorer who found this great underground citadel of the Grand Canyon during a trip from Green River, Wyoming, down the Colorado river, in a wooden boat, to Yuma, several months ago. According to the story related to the *Gazette*, the archaeologists of the Smithsonian Institute, which is financing the explorations, have made discoveries which almost conclusively prove that the race which inhabited this mysterious cavern, hewn in solid rock by human hands, was of oriental origin, possibly from Egypt, tracing back to Rameses. If their theories are born out by the translation of the tablets engraved with hieroglyphics, the mystery of the prehistoric peoples of North America, their ancient arts, who they were and whence they came, will be solved. Egypt and the Nile, and Arizona and the Colorado will be linked by a historical chain running back to ages which stagger the wildest fancy of the fictionist.

A Thorough Investigation.

Under the direction of Professor S. A. Jordan, the Smithsonian is now pursuing the most thorough explorations, which will be continued until the last link in the chain is forged. Nearly a mile underground, about 1480 feet below the surface, the long main passage has been delved into, to find another mammoth chamber from which radiates scores of passageways, like the spokes of a wheel. Several hundred rooms have been discovered, reached by passageways running from the main passage, one of them having been explored for 854 feet and another 634 feet. The recent finds include articles which have never been known as native to this country, and doubtless they had their origin in the orient. War weapons, copper instruments, sharp-edged and hard

as steel, indicate the high state of civilization reached by these strange people. So interested have the scientists become that preparations are being made to equip the camp for extensive studies, and the force will be increased to thirty or forty persons.

Before going further into the cavern, better facilities for lighting will have to be installed, for the darkness is dense and quite impenetrable for the average flashlight. In order to avoid being lost, wires are being strung from the entrance to all passageways leading directly to large chambers. How far this cavern extends no one can guess, but it is now the belief of many that what has already been explored is merely the "bar-racks", to use an American term, for the soldiers, and that far into the underworld will be found the main communal dwellings of the families. The perfect ventilation of the cavern, the steady draught that blows through, indicates that it has another outlet to the surface.

Mr. Kinkaid's Report.

Mr. Kinkaid was the first white man born in Idaho and has been an explorer and hunter all his life, thirty years having been in the service of the Smithsonian. Even briefly recounted, his history sounds fabulous, almost grotesque:

"First, I would impress that the cavern is nearly inaccessible. The entrance is 1,486 feet down the sheer canyon wall. It is located on government land and no visitor will be allowed there under penalty of trespass. The scientists wish to work unmolested, without fear of the archaeological discoveries being disturbed by curious or relic hunters. A trip there would be fruitless, and the visitor would be sent on his way. The story of how I found the cavern has been related, but in a paragraph: I was journeying down the Colorado river in a boat, alone, looking for mineral. Some forty-two miles up the river from the El Tovar Crystal canyon, I saw on the east wall, stains in the sedimentary formation about 2,000 feet above the river bed. There

was no trail to this point, but I finally reached it with great difficulty. Above a shelf which hid it from view from the river, was the mouth of the cave. There are steps leading from this entrance some thirty yards to what was, at the time the cavern was inhabited, the level of the river. When I saw the chisel marks on the wall inside the entrance, I became interested, securing my gun and went in. During that trip I went back several hundred feet along the main passage, till I came to the crypt in which I discovered the mummies. One of these I stood up and photographed by flashlight. I gathered a number of relics, which I carried down the Colorado to Yuma, from whence I shipped them to Washington with details of the discovery. Following this, the explorations were undertaken.

The Passages.

"The main passageway is about 12 feet wide, narrowing to nine feet toward the farther end. About 57 feet from the entrance, the first side-passages branch off to the right and left, along which, on both sides, are a number of rooms about the size of ordinary living rooms of today, though some are 30 by 40 feet square. These are entered by oval-shaped doors and are ventilated by round air spaces through the walls into the passages. The walls are about three feet six inches in thickness. The passages are chiseled or hewn as straight as could be laid out by an engineer. The ceilings of many of the rooms converge to a center. The side-passages near the entrance run at a sharp angle from the main hall, but toward the rear they gradually reach a right angle in direction.

The Shrine.

"Over a hundred feet from the entrance is the cross-hall, several hundred feet long, in which are found the idol, or image, of the people's god, sitting cross-legged, with a lotus flower or lily in each hand. The cast of the face is oriental, and the carving shows a skillful hand, and the entire is remarkably well preserved, as is everything

in this cavern. The idol most resembles Buddha, though the scientists are not certain as to what religious worship it represents. Taking into consideration everything found thus far, it is possible that this worship most resembles the ancient people of Thibet. Surrounding this idol are smaller images, some very beautiful in form; others crooked-necked and distorted shapes, symbolical, probably, of good and evil. There are two large cactus with protruding arms, one on each side of the dais on which the god squats. All this is carved out of hard rock resembling marble. In the opposite corner of this cross-hall were found tools of all descriptions, made of copper. These people undoubtedly knew the lost art of hardening this metal, which has been sought by chemists for centuries without result. On a bench running around the workroom was some charcoal and other material probably used in the process. There is also slag and stuff similar to matte, showing that these ancients smelted ores, but so far no trace of where or how this was done has been discovered, nor the origin of the ore.

"Among the other finds are vases or urns and cups of copper and gold, made very artistic in design. The pottery work includes enameled ware and glazed vessels. Another passageway leads to granaries such as are found in the oriental temples. They contain seeds of various kinds. One very large storehouse has not yet been entered, as it is twelve feet high and can be reached only from above. Two copper hooks extend on the edge, which indicates that some sort of ladder was attached. These granaries are rounded, as the materials of which they are constructed, I think, is a very hard cement. A gray metal is also found in this cavern, which puzzles the scientists, for its identity has not been established. It resembles platinum. Strewn promiscuously over the floor everywhere are what people call 'cats eyes,' a yellow stone of no great value. Each one is engraved with the head of the Malay type.

The Hieroglyphics.

"On all the urns, or walls over doorways, and tablets of stone which were found by the image are the mysterious hieroglyphics, the key to which the Smithsonian Institute hopes yet to discover. The engraving on the tablets probably has something to do with the religion of the people. Similar hieroglyphics have been found in southern Arizona. Among the pictorial writings, only

two animals are found. One is of prehistoric type.

The Crypt.

"The tomb or crypt in which the mummies were found is one of the largest of the chambers, the walls slanting back at an angle of about 35 degrees. On these are tiers of mummies, each one occupying a separate hewn shelf. At the head of each is a small bench, on which is found copper cups and pieces of broken swords. Some of the mummies are covered with clay, and all are wrapped in a bark fabric. The urns or cups on the lower tiers are crude, while as the higher shelves are reached the urns are finer in design, showing a later stage of civilization. It is worthy of note that all the mummies examined so far have proved to be male, no children or females being buried here. This leads to the belief that this exterior section was the warriors' barracks.

"Among the discoveries no bones of animals have been found, no skins, no clothing, no bedding. Many of the rooms are bare but for water vessels. One room, about 40 by 700 feet, was probably the main dining hall, for cooking utensils are found here. What these people lived on is a problem, though it is presumed that they came south in the winter and farmed in the valleys, going back north in the summer. Upwards of 50,000 people could have lived in the caverns comfortably. One theory is that the present Indian tribes found in Arizona are descendants of the serfs or slaves of the people which inhabited the cave. Undoubtedly a good many thousands of years before the Christian era a people lived here which reached a high stage of civilization. The chronology of human history is full of gaps. Professor Jordan is much enthused over the discoveries and believes that the find will prove of incalculable value in archaeological work.

"One thing I have not spoken of, may be of interest. There is one chamber the passageway to which is not ventilated, and when we approached it a deadly, snaky smell struck us. Our lights would not penetrate the gloom, and until stronger ones are available we will not know what the chamber contains. Some say snakes, but others boo-hoo this idea and think it may contain a deadly gas or chemicals used by the ancients. No sounds are heard, but it smells snaky just the same. The whole underground installation gives one of shaky nerves the creeps. The gloom is like a

weight on one's shoulders, and our flashlights and candles only make the darkness blacker. Imagination can revel in conjectures and ungodly daydreams back through the ages that have elapsed till the mind reels dizzily in space."

An Indian Legend.

In connection with this story, it is notable that among the Hopi Indians the tradition is told that their ancestors once lived in an underworld in the Grand Canyon till dissension arose between the good and the bad, the people of one heart and the people of two hearts. Machetto, who was their chief, counseled them to leave the underworld, but there was no way out. The chief then caused a tree to grow up and pierce the roof of the underworld, and then the people of one heart climbed out. They tarried by Paisisvai (Red River), which is the Colorado, and grew grain and corn. They sent out a message to the Temple of the Sun, asking the blessing of peace, good will and rain for the people of one heart. That messenger never returned, but today at the Hopi villages at sundown can be seen the old men of the tribe out on the house-tops gazing toward the sun, looking for the messenger. When he returns, their lands and ancient dwelling place will be restored to them. That is the tradition. Among the engravings of animals in the cave is seen the image of a heart over the spot where it is located. The legend was learned by W. E. Rollins, the artist, during a year spent with the Hopi Indians. There are two theories of the origin of the Egyptians. One is that they came from Asia; another that the racial cradle was in the upper Nile region. Heeren, an Egyptologist, believed in the Indian origin of the Egyptians. The discoveries in the Grand Canyon may throw further light on human evolution and prehistoric ages.

*This article was reprinted in the book **Lost Cities of North and Central America** by David Childress, Adventures Unlimited Press, Stelle, Illinois, 1992, available from BSRF for \$14.95 + \$2.75 p&h. Upon further research David found that this newspaper article was authentic, but the Smithsonian Institute currently denies any knowledge of the affair. Today the area is said to be off-limits to all, including Park Service personnell!*

NEWS 'N VIEWS FROM THE BORDERLAND

LETTERS

TRUE HUMAN POTENTIAL

We hope we will not take too much of your time as we introduce ourselves to you. We, the staff of Paramann Program Laboratories, would like to give you a brief description of this program. Ten years ago a group of experimental physicists and experts in medical sciences started this program by scientifically studying those phenomena of unusual body reaction to pain, injury and infection as demonstrated by swamis, gurus, fakirs, ... etc. We were hoping to succeed to make medical science overcome human pain, injury and infection. We started trying to make usual individuals succeed to exhibit those phenomena which had long been thought to be restricted to few talented individuals, who have been involved in certain procedures of (jahrelangen Konzentrationsubungen) without being obliged to follow their very many-year procedures which require too much toil and time to make "adherents" acquire such unusual abilities. Of course, we had to make experiments on both ordinary humans and those unusual humans endowed with super-ability to overcome pain and to have their injuries healed within few moments without any infection. It took us about four years of continuous searching for such individuals before we could find large number of individuals with such unusual abilities. It was rather difficult to proceed with our experimentations before we meet Tariqa Casnazaniyyah which kindly made it possible for us to go on experimenting on its followers who are astoundingly endowed with those unusual abilities mentioned earlier. Tariqa Casnazaniyyah is an old sufi doctrine which goes back to the seventh century. This Tariqa has a chain of Masters who received its secrets and powers through the centuries, one Master from the other till this time where Ash-Shaikh Mohammad Al-Casnazani is the present Master of the Tariqa. Tariqa Casnazaniyyah offered us the opportunity to carry out experiments on whomsoever of its adherents. Due to an unlimited cooperation between Tariqa Casnazaniyyah and Paramann Programme Laboratories it was possible to perform hundreds of highly-sophisticated experiments on its dervishes all of whom are endowed with the unusual reaction to pain, injury and infection exhibited by their powerful schmerz-demonstration. About the year 1988 a technique called Spontaneous Transmission was developed inside our laboratories. This technique allowed the mass production, to put it so, of individuals capable of SuperReaction to pain, injury and infection on performing

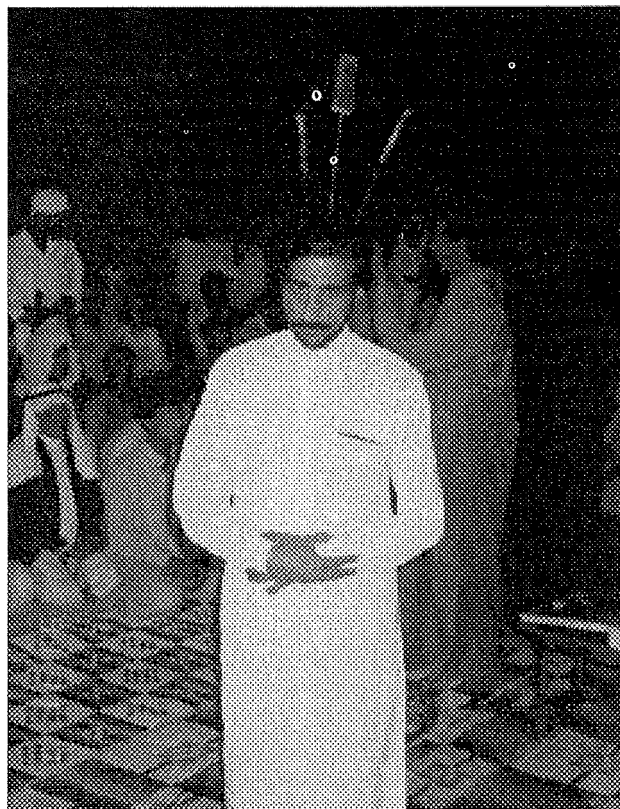

Schmerzdemstration. Again, hundreds of experiments were carried out to test this new technique. Results did prove beyond doubt that those abilities once thought to be the outcome of hard training lasting for many years are no longer restricted by that very condition. According to all those who have made researches in the field of Schmerzdemstration, the ability to control pain and for ensuing injuries instantaneously heal and with no infection is so restricted to only few individuals that no such thing as mass-production of such unusual individuals is observed. Suffice it to recall what Dr. Wolfgang Larbig (one of the prominent pioneers who investigated this field) observed that not before many years of hard training could one succeed to reach at performing successful Schmerzdemstration. Dr. Hiroshi Motoyama is also of the same opinion. Another technique called Switch Technique was come across accidentally inside our laboratories. This technique made possible the refutation of whatsoever an unusual ability of the kind described above when "off" - mechanism is being used. Rigorous experimentation proved this technique to be valid in the successful refutation of many cases of Schmerzdemstration performed by swamis, fakirs, gurus, etc. We do believe that what we

have succeeded to develop inside Paramann Programme Laboratories can help science in so many ways. We hope that our programme be of interest to you so that we can make joined researches together in fields of mutual interest.

I wait eagerly to hearing from you the very soonest you can.

Yours very sincerely,

Jamal N. Hussein, Ph.D.,

Chief of Paramann Programme Laboratories

Al-Mahatta,

Amman, JORDAN

Thank you for contacting us and letting us know of your researches. This information is of prime interest to our readers and we look forward to a future exchange of information

IT OUGHT TO RAIN

I am a recent subscriber to your *Journal* and usually only have time to skim some of the items. Over the holidays, however, I had a little time to look a bit closer at some of the articles and thought I noticed a few apparent discrepancies. I've outlined only two below, but I wonder if you would mind publishing this letter or at least see if the author, Mr. Trevor Constable, would kindly provide us with his explanations.

1 - In his letter in the Nov-Dec. issue of the *Journal of Borderland Research* Mr. Constable states he was in Malaysia in July and August and that he twice brought rain during the dry season. But being that close to the equator it ought to rain hard — and often — especially during July and August. If I'm not mistaken, both the National Climate Data Center and the *World Atlas of Climatology*, cite January and February as being the two driest months of the year.

2 - Mr. Constable also describes a series of seven storms he created, the first of which (if I understood him correctly) wrecked his own base. What motivated the six successive attempts right on the heels of the first harrowing experience? Did he modify the subsequent attempts so as to avoid repeating the destruction? If so, he should have been more explicit. I'm afraid there are all too many skeptics out there who'd love to ridicule the likes of Mr. Constable for not being able to learn from experience — and they may even see

fit to ridicule your readers for not inquiring into such apparent discrepancies as these.

John W. Patterson
Ames, Iowa

TREVOR'S REPLY

Regarding John Patterson's letter:

John seemingly attributes to me a statement that I TWICE brought in rain during the 1991 dry season in Melaka, Malaysia. I think he really means that I have mentioned it twice, rather than done it twice. The facts are that our team brought in THIRTY-SIX measurable rains in 57 dry season days, between 1 July and 27 August 1991. 13 inches were measured at our base atop the Emperor Hotel. This was about 80% of a full year's rainfall.

By way of illustrating just how much rain that really is, California was pushed to the brink of crisis by the January 1993 chain of Pacific storms, which laid about 10 inches on downtown Los Angeles, leaving extensive damage. The engineered rainfall in Melaka, by contrast; which produced no significant damage, was thus fairly well managed.

The Melaka rain gods were not listening to classical edicts, and withheld their bounty.

John's critical assertion that because Melaka is near the equator, it ought to rain hard — and often — during July and August, does not spring from true wisdom. Such wisdom develops primarily from direct practical experience of the world. Some classical books and authorities, such as the *World Atlas of Climatology* and the National Climate Center vaguely cited by John, have absolutely NO VALUE in situations like those faced by the government and people of Melaka. They were in severe drought with no immediate way out, regardless of the classical climatic parameters laid out in books. Melaka furthermore, is not only the smallest, but also the DRIEST state of the mainland Malaysian Federation, notwithstanding Melaka's location about 100 miles north of the equator. What do the classical books say about this fact of Malaysian life?

I would agree with John that such an equatorial location "ought" to result in lots of hard rain. That is the way things seem if you are evaluating them somewhere in the U.S.A. and relying on classical information. That is where our seemingly rational "oughts" originate. Among the many microclimates of the south-

ern Malay Peninsula nevertheless, the real world pays little heed to academic "oughts". The dry season in southern Malaysia and Singapore is locally deemed to be July/August. This is not "dry" in the arid desert sense but rather a 60-day period of lesser rainfall than Singapore, as a prime example, experiences during the remainder of the year.

To bridge this relatively dry annual period, the Singapore government, in recent years has invested some 300 million Singapore dollars in new water catchment construction. Sure, it ought to rain hard there in July & August according to the books, but it doesn't. Singapore in the past was compelled to import considerable amounts of dry season water from the southernmost Malaysian state of Johore — where rain is sufficient to produce a water surplus.

Northwest of Johore on the east shore of the Melaka Strait, yet another equatorial dry spot is encountered in the small state of Melaka. Conditions developed there in the winter and spring of 1991 that most laymen would have difficulty comprehending, given Melaka's proximity to the equator and location right on the ocean. Due to circumstances never adequately explained to the Operation Pioneer team, either by the Melaka government or anyone else, the Durian Tunggal dam which services the state, ran dry in the winter and spring of 1991. Melaka's rainfall failed to appear in normal quantities in this same period. Sure, it ought to have rained more, but again, it didn't. The Melaka rain gods were not listening to classical edicts, and withheld their bounty.

Water rationing was therefore forced upon the Melaka government. Americans have no conception of what difficulties have to be surmounted in these less developed countries, in such circumstances. Our droughts in the USA are essentially POLITICAL AND FINANCIAL EVENTS. Our Federal and State governments have no real interest in alleviating such situations, because of illicit profiteering and graft, and bureaucratic machinations aimed at extorting appropriations for their empires. Our American droughts are essentially phoney.

In Melaka, the drought was a devastating crisis affecting virtually every citizen, and the government, directly as a physical event, and financially through the drought's burdensome cost. The water level in the Melaka River was below the intake, and there was no pressure in the entire municipal water system. Water had to be hauled by truck from Johore to the residential neighborhoods, where it was passed into cans and drums outside the homes. Two or three times a week, the people could be seen staggering back and forth, moving water into their homes. Everyone humping these loads of water would surely have agreed with John

Patterson, that it OUGHT to rain — for the love of Allah. Some 150 water trucks were in such service when we Americans arrived. Our task was to deliver the Melaka people from some of their miseries, in the dry season.

Rationing costs were huge. The trucking program alone cost a mind-boggling 300 Malaysian dollars per 500 gallon truckload — a big business based on misery. The water trucking combine made it clear that we were not welcome, and threatened sabotage. There were vested interests who did not wish us to succeed.

The sheer desperation of the situation in Melaka is verified by the decision of the government to hire us. This proves better than anything else the extremity Melaka had reached. *Things were so bad, they would even hire me.*

As I have stated before, Operation Pioneer had kiboshed water rationing within a week of start up. Later on in July, experiments were undertaken with a modified marque of the Spider, working in a radically different fashion to its original design. This proved dramatically effective in generating miniature typhoons, which rained heavily in the state of Melaka. This work was all done in the small hours of the morning, when the city was deserted, and the populace in bed.

Certainly it is true that the first use of this device wrecked our own base atop the Emperor Hotel, and thoroughly busted up the Spider that generated this weather system. The experience was nevertheless not “harrowing” to me in any way — as John Patterson assumes — but was a triumph of weather engineering as an advance in the art. Additional similar mini-typhoons were indeed engineered, scaled down, but were still accompanied by nocturnal gales, heavy rain and street flooding. Lightning sometimes registered at 60 to 90 strokes a minute, and some of it was videotaped. I once was able to read a newspaper illuminated by lightning at 2 am at our hotel-top base. There was some street flooding in the poorly drained city, and the thunder was literally deafening, out in the open on the 33 story-high roof of the Emperor Hotel. Trees were sometimes uprooted, and some were hurled three or four blocks, but nobody was injured. I have a priceless piece of video tape showing a laden water truck lumbering through a 4am deluge in downtown Melaka.

John Patterson asks what motivated me to mount additional such operations after the first one wiped out our own base. Easy, I was motivated by Chief Minister Rahim of Melaka, who had contracted with us for rain. He wanted rain, and he wanted Melaka’s dam filled, no matter what the collateral damage. The Chief Minister of a Malaysian state occupies a position of political leadership corresponding to that of a state governor in the U.S.A. Chief Minister Rahim had signed a contract in which

the State of Melaka assumed full responsibility for any damage. He wanted ACTION AND RESULTS. We no longer produce this kind of courageous political leadership in the U.S.A., save for a few congressional stalwarts like Congressman Gonzalez and Trafficant.

The Malaysian media, full of spite against anything not completely orthodox, safe and thoroughly pasteurized, assailed us and Chief Minister Rahim on almost a daily basis. His response, which the media found rationally unanswerable, was: “It is raining in Melaka. Nothing else matters.” The rain had to be kept going not alone for the relief of the desperate Melaka people, but also to give the brave and visionary Rahim what he needed to deal with the press. He also had to deal with unscrupulous political foes, indifferent to the suffering of the Melaka people when the trade-off was political advantage. This should answer for John Patterson why risks were run and dice were rolled in the way I have related. Anyone who is unwilling to run risks in such circumstances, should stay out of weather engineering. Men of action have throughout history run risks, and made abundant mistakes as the price of progress. That is what distinguishes them from their pallid contemporaries, who waste one incarnation after another.

As for John’s fear that someone might accuse me of not learning from experience — because of the repeated heavy rains after the first mini-typhoon — well, NOBODY has ever accused me of THAT. Everything I have learned about engineering the weather is based upon experience. There is no other source of authentic knowledge. No use scrabbling through the preserving jars that we call books or haunting government offices for something to cleave to. Should you run to the tome and organization that John seems to depend upon for information and orientation, and ask them about weather engineering, they will say that it cannot be done, except on Star Trek.

That is because their world view does not rest upon my kind of practical experience. They live on in their etherless universe, and my ether-filled world is invisible to them. That is the difference between them and me. Sometimes I thought about all that when the roaring of the gale around the top of the Emperor Hotel was drowned out by the sustained crashing of the deluge, descending on a thousand tin roofs below.

NOTE FROM RILEY

What a welcome change in the face of the Journal, and some inside changes too. Signs of progress. Your lead article, “That which is eternal in us must be awakened” is quite a review of metaphysical disciplines, of which I considered myself a good

example, after 20 years of dedicated effort with the Five Rites — to which I added the yogi headstand and reflexology. Then came the Stroke last year and my phenomenal good health was no more. I said to hell with it, and dropped the routines altogether for awhile. Some could not be done anyhow and I had to concentrate on rehabilitating my right arm and hand. It’s a slow, slow business, rebuilding dead nerves, but I can now tie my shoes again, and playing the piano will have to wait quite a while. The Rites are beginning to look appealing again, I might even add the headstand.

I’m getting tired of this left-hand typing. So if you’ll excuse me, may the peace of the Western Mystery Tradition be with you.

**Riley Crabb, BSRF
161A Centreway Road
Orewa, Hibiscus Coast
New Zealand**

Glad to hear from you Riley, and that you enjoy the change in our look. Hard to believe it’s been seven years since you retired as Director of BSRF — and editor of this publication. My article was rather incomplete from my point of view and I hope to expand it in the future to cover many systems which were not mentioned. The Five Rites remain quite popular and interest is growing — people like to be in top shape! And while your body may be aging Riley, I’m sure you’re more than capable of the mental gymnastics such as those which you presented to Borderlanders for 25 years.

EARTH ENERGIES

Please excuse my belated thank you for printing my plans in the May-June 1992 Journal. I almost could not believe that “Power from the Ground” carried enough merit to be published since it’s only a skeleton guideline for the layman.

I would also like to comment on a few of the excellent articles in the Sept-Oct 92 issue. The three articles by Michael Theroux and Michael Riversong are worthwhile extensions of an ancient, timeless Science. The theory and practice of living in harmony with nature has been around for ages, but as Michael Theroux inferred in his article on Ancient Cosmography—a basic restructuring of attitude and lifestyle in the general populace is quite necessary.

Although it may seem that modern mechanistic civilization has

found a different foundation, each new generation cannot deny the gaps existing in "classical" science or ourselves as a living part of nature—just as we cannot deny our own happiness and fulfillment. In this respect, there is an endless ray of hope.

Thank you for keeping the fire burning through your publications.

Sincerely

Randolph Fabian Directo
Mountain View, California

Thanks for giving us your "skeleton guideline" to work with. We hope to hear more of these researches in the future. Longtime researcher Herman Meinke called and said that the capacitor values in that article seem too high. If you or anyone experimenting with this project can provide working values, please let us know.

ECSTATIC CONJUNCTION

I wanted to express to you and your office how much I appreciate your recent (new format) publication. It certainly excited me. I hope that you have received many other enthusiastic letters such as this. Unfortunately, where I find myself, there is not one who is willing to step outside the evident "struggle for the norm" and delve into concepts such as presented - oh well. I'm thankful for certain publications such as yours and the telephone, even if it might be bugged..

For some reason, I have been compelled to share something with you. Enclosed, I send to you a pic-

ture of my first airbrush painting, a form of expression I have always dreamed of participating in. I have titled the painting "Conjunction in Ecstasy." To me, it is a representation of what is presently happening (astronomically). In the foreground, Uranus, with its tilted rings and five moons moves into conjunction with Neptune. This planetary occurrence happens only every 171.40 years. What makes this alignment so significant is the fact that Uranus and Neptune will park right in front of a relatively close and unusual galactic entity. This system is termed "SS433." It is a binary star group consisting of a yellow giant and a neutron star. SS433 tilts at an unusual angle, providing the binary system with a periodic wobble - which half the time appears to be approaching Earth (blue shift) and half the time seems to be receding (red shift). When astronomers draw the patterns of light shifts seen from SS433, its spiraling pattern closely resembles the double helix structure of the DNA molecule.

This event, I sense to be of certain significance. Uranus could be felt as liberation, individualism, freedom of self-expression. Neptune could be felt as imagination, sensitivity and spirituality. SS433 could be expressed as "Namaste," a Sanskrit term meaning that one recognizes the Divinity in itself and others, a bi-directional spiritual mir-

roring and/or biophysical awareness. What I attempt to say in this picture is: Recognize your unique inner energy and claim full birth-right of your creative power. Overcome the fear of accomplishment. Breathe. Take a stand and show others how to heal. Birth be given to that which has been nurtured in your heart for so long ...Love.

Julie Hovar-Goebel
San Rafael, California

CROP CIRCLES

Michael Theroux's article "Ancient Cosmography and the Crop Circles" is a fine integration of many aspects of "life energy" done in a concise, readable way... and well illustrated. Seldom does a four page article bring together so much that is related yet never before connected.

The whole staff of BSRF, and a great many of your contributing authors, have added a great deal of insight and enjoyment to my life. It is always with a happy anticipation that I open each new issue. There is no other publication that is as broad in scope, quality, and openness to many helpful insights as your.

Best wishes

Anton Kiss

Morganville, New Jersey

EARTHQUAKES & STUFF

With increased Earthquake activity & interest perhaps a few observations would be helpful. While instruments fail to be reliable in predicting quakes there are a number of interesting alternatives. The most convenient way has always been to just observe animals. Many species free themselves of danger prior to quakes & other disasters. A more scientific method of projection was worked out by Bill Whamond of Canada a few years back. He worked out a 'harmonic progression' that tied in with Cathie's time harmonic theories.

When a nuclear blast is set off there are standing wave patterns set up that usually surface elsewhere in a predictable manner. Actually almost everything is interconnected and a number of native Americans are proficient at quake prediction from the use of cycles. Willy Whitefeather of 2802 N. Alvernon Way, Tucson, Arizona, 85712 is an example who regularly shows how

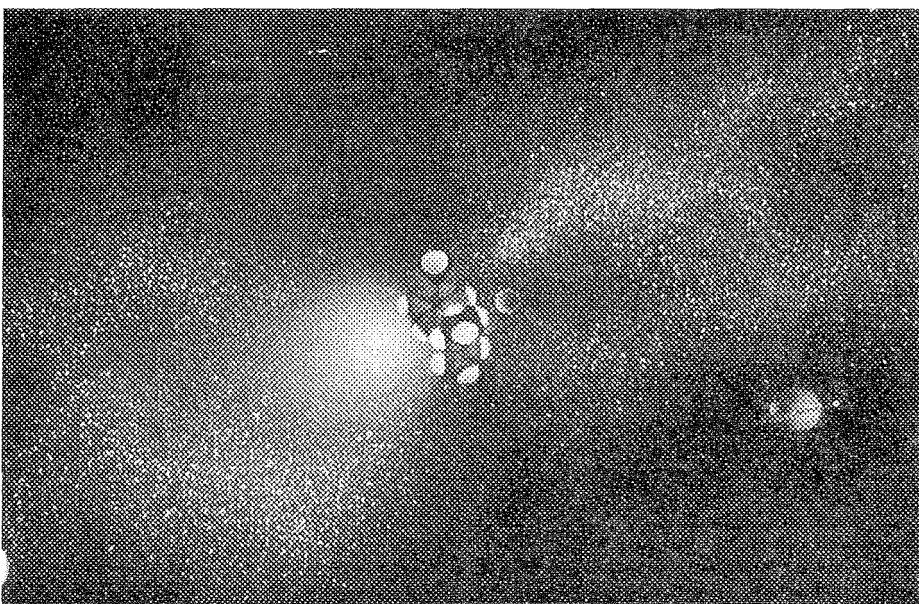

CONJUNCTION IN ECSTASY, airbrush by Julie Hovar-Goebel

regular 14 day cycles can predict distant tremors & quakes. Most 'sensitives' are well aware that Earth is a living entity with a nervous system that relates to Ley lines. The higher level censored science of the 'elite' takes such things into consideration & most military bases are built on energy intersections. They can alter weather & create quakes at will as far as I & a number of others are concerned. Going too far into just what technology is put to use is a dangerous subject however. Fortunately, Earth has a number of built in safeguards and a lot of help from higher level observers. Our scientists may pollute us with enough radioactivity & cultured viruses to wipe out our species, but Earth can always get cleaned up & start again.... In the past native Americans tried to aid the planet with simple technology that we ignore today. The perfect example would be the medicine wheels of stone used to smooth out the vibes over nodal energy points.

According to most seers, the years ahead will get more chaotic and not only will we have quakes, but violent weather & changes. As we continue to do nuclear testing north of Las Vegas it is apparent that those in power simply don't care about the rest of humanity. Fault line running west from this area are bound to carry this deadly contamination to the surface once we get a rash of quake activity. What this will do to our populated areas should be self evident. Getting ready for the fun ahead is easy with a little simple logic, yet few will bother...

Al Fry
Garden Valley, Idaho

EARTH BATTERIES

Because of the recent references to "earth batteries" in recent BSRF Journals you might wish to indicate to your readers that according to a statement in an article on page 14 of the Fall 1992 issue of Invention & Technology that the first electric clock was an "earth battery" powered clock built about 1845 by Alexander Bain.

Ed O'Brian
Huntington Beach, California

Gerry Vassilatos has unearthed the work of Mr. Bain and more is to come of this in the future.

NEW BORDERLANDS

Your new BORDERLANDS magazine looks good with a slick cover and I was happy to see TOYS OF JUPITER so well laid out. I notice that the cover illustration shows the bolts of Jove affecting a city. Your issue was perfectly timed to coincide with the explosion at the World Trade Center here. I agree with your article's intention as regarding modern ignorance of the effects of the Chi energy.

Robert McCullough's letter in a earlier issue about the DOR is also quite perceptive in the narration of unique and original experience with the link between this organic energy and salt. I have noticed that there is an effect upon the water retention within my body after I have deliberately channeled energy either in healing or as part of a public performance situation. My weight can suddenly vary as much as five pounds—usually a weight loss after the channeling accompanied by a thirst. I am also quite sensitive to salt as a rule and have learned to forego pretzels while dowsing.

Eugenia Macer-Story
Magick Mirror Communications
New York, New York

VITIC ENERGY

I have been very pleased with your VITIC. I want to order 2 more. I am a member
Dr. Bara H. Fischer
Sedona, Arizona

REPORT FROM 'UP OVER'

Please find my annual subscription. I do enjoy the articles & thanks for all the stimulation.

I keep a rough record of sunspots, solar flares, earthquakes, volcanic eruptions, earth's magnetic field, atomic explosions, fallout, ions & rain. There were 5 atomic explosions, Nov 23 +15%, Nov 26th +30%, Dec 15th +9%, from these there was still 24% fallout, on Dec 24th there was another atomic explosion & on the same day the fallout jumped to 75% & Ions +80% this was the highest reading I had recorded. On 28th there was another explosion +9% & the fallout jumped to 84% the highest ever, ions +15%. On 31st there were two big cyclones — Nina & Tina — in the Solomon Islands & Fiji & fallout dropped suddenly to +20%.

We had light rain for three days after the Xmas eve explosion but not after the one on 28th. But there was an earthquake in Japan on that date. I was very busy with patients at this time & had a few schizophrenics. Could the positive ions have something to do with Oranur? I'm sure its all tied up with the cyclones. What a mess we have made of the world!

Our group "Living Wholeness Inc" is putting on an open day on the environment & the Agni Hotra people are giving a demonstration of making the sacred ash for the purification of the atmosphere & some of our group will speak on the environment & health.

I did pick up DOR in a house of a cancer patient. The old weather board house was aluminium clad & the man had kerosene tins filled with water all round the house too! These would have been useless in a fire for which he kept them!

One other odd case was allergic to all types of radiation & there was an old coal mine, an underground stream which bifocated & nuclear waste was dumped between the two branches. There were transformers & various other things including radon & methane. I could not stabilize her for about 4 hours but as soon as the sun set both she & the land became all clear. Why? I felt she must have been so negative in her thoughts & they were resonating with the 'nasties' under the house. We must be careful. The woman has not regressed since.

Please do not quote my name as I have too much work already, but I thought you or some of your colleagues might be interested.
Name withheld on request
Australia

MULTIDIMENSIONAL ENERGY

I am now running a small lab which I call (translated) Multidimension Bioenergetics Research Center. I agree with you (BSRF May-June 1992, p.8) that it is in subtler energy realms rather than in bioelectronic or bioelectrical domains, where there is a most powerful source of well being for everyone. That is the true purpose in the Borderland fields of research: to attain a full view of our existence, as you said. Although non-conventional bioelectronic information processing in organisms

is a part of nature still to be completely understood (and also is an important part of any holistic model of biological beings) my field of research lies mainly in the subtler regions of being.

It would be interesting if more often we could see biology articles in the BSRF bulletin. Of course every article I have read on it anyhow has a relation to biology. Maybe sometime you will give me the opportunity to write on it.

I wonder if there are any other Mexicans with BSRF. I would like to get in touch with them. Maybe it is time for us to organize down here.

Thanks for your work and that of all the BSRF crew.

At your service.

Enrique Ortiz Dávila
Uruapan, Michoacán
Mexico

It is nice to hear of your researches and we all wish you success! If any of our readers 'South of the Borderland' would like to get in touch with you we will give them your address.

ANONYMOUS INSIGHTS

I thank you for printing my last letter to you, as well as your honoring my request to remain anonymous. In these times of great turmoil, I feel it necessary to write only on that basis.

Since receiving of the latest Borderlands "Journal", there has been a growing inside me to get "off my chest" something that I feel needs saying. However, it is difficult to know just how to phrase my thoughts without sounding even a little bit critical, which I do not wish to be.

BORDERLANDS exists as one of only a few remaining forums of non-mainstream science. If this be so, then it is of vital importance that it base itself upon a foundation(s) of total correctness. That this is not presently being done, is, in my humble opinion, reason enough to fear that all well-intentioned efforts will only create another pseudo-science, just as the present mainstream collage of "Ivory Tower non-Thinkers" has accomplished. In fact, a perusal of several past issues reinforces that viewpoint. There are (thankfully) a goodly number of inquisitive and creative-minded beings throughout our society(s), that have in mind bringing forth new ideas which would, in the long or short term, be of benefit to all of mankind. After all, that is just what any science should be thought to do. However, they are stymied by three very large obstacles, as well as several lesser ones.

One, "they" have no set standards to base their work upon. One example: the work(s) on so-called "Ethereic Energies". Many have found "it", or should I more correctly say "IT", but not knowing what "IT" is, have given "IT" several names (Vril, Chi, Or-gone, Od, Prana, Mana, Ether, etc.). Not knowing correctly what "IT" is, in reality, "they" produce a scenario (or ten) and dwell on what can be done with it, without ever determining its reason for being present. Know-

ing the correct reason for the finding of such would establish a foundation or "standard" which one could then build upon (point A to point B). The situation at present is clouded by great uncertainty because of this. There is at present no point B, therefore there can be no actual beginning.

Two, whenever anyone scientific/creative discovers anything that might serve the interests of mankind, the corrupt "power-mongers" decide whether or not to use it for their interests of power over the many, or merely to make vast sums of gold from, or else the discovery gets buried somewhere. Not very much good can come from such a society, as all suffer for that. Is there a solution for this? Indeed there is, and in fact, the beginnings of such are already in place, which should serve notice to those aware ones, as to how not fall into the same trap over and over and over.

Three, and without question the most important of all the above-mentioned factors, is that of mankind's seeming unawareness of his spiritual origins. That is to say, man has a Creator. Many call this Creator "God", which is fine (and quite apt). In my last letter, I used the word "God", and I could have better said "God/Creation", but felt it would be misunderstood. What am I saying? Until we of mankind awaken to our spiritual connections with God/Creation, mankind will not find the answers to that which he is looking for with human brains and non-working minds. A point I feel is worthy of remembering is that "God" will work *with* one, but never *for* one. Would anyone be any different? All we really need to know is how to ask. And that lies within all our individual beingness.

Now with that said, let's suppose that "we" do ask. Does that mean that automatically God/Creation is interested? Why, indeed should HE be? Creation is giving to us with each breath of thought. When we learn to regieve of our innate properties is when Creation responds to our earned requests, but seldom to never without that balanced equation. All of Creation is continually striving for a balance.

How do I know? I KNOW! What lies just ahead for all of us here on

BEST KEPT SECRET IN SCIENCE...

Nikola Tesla

— *The Man Who Invented The 20th Century.*

Inventors, investors, educators, scientists, engineers, students, businessmen.... anyone who is interested in seeing science and technology stretched to their limits, attend the 1993 Extraordinary Science Conference!!! Watch as our speakers bring forth what may well be the foundation of the next century's technology base... as Nikola Tesla did 100 years ago. Determine for yourself the validity of our speakers' claims as you observe them demonstrating actual models!!!

Get a glimpse of the FUTURE Today!!!

Attend the 1993 Extraordinary Science Conference

-- July 22- July 26

International Tesla Society
PO Box 5636
Colorado Springs, CO 80931
Or call (719) 475-0918

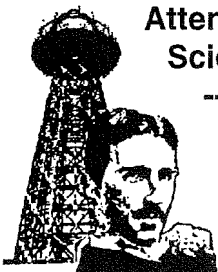

earth is both wonderful and upsetting. But without Creation in the equation of this life, for all of our time here, it may well remain more "upsetting" than "wonderful". Be it so said.

Thank you for allowing of this opportunity to encourage those who are trying so hard to find the answers that seemingly lie just out of reach. Our world will be the better for such, when those answers are found. I again ask that my name be left from this letter. There is yet too much risk involved.

Name withheld upon request

Thank you for your thoughts, but I completely disagree with your statement that this publication is not based upon a foundation of total correctness. If it were not there would be no purpose in our pursuit of knowledge. Sure, people make mistakes, and we always stand ready to correct any errors of fact which creep into our pages, but we strive for complete correctness in all we do. You may not agree with what is written in the issues you brushed back through, but you fail to mention one specific error, and we refuse to accept generalities in this area! There have been many experiments which describe exacting characteristics of the etheric energies, under whatever moniker the experimenter chooses to place upon them (or IT). These physical experiments stand as empirical evidence, and far from having nowhere to start there are experimenters all over the world working with these energies, and many, many articles on such have shown up on these pages over the decades. Before you criticize that which you are not versed in you would do well to do some homework in the area. We have never been shy about referring people to the correct information. You may want to start with the works of Wilhelm Reich describing quantifiable thermal and luminous properties of the Life energy (termed *orgone* by Reich). You may also want to look at the ether drift experiments of Dayton Miller wherein he also described exacting measurements of the allegedly non-existent ether. And far from "clouds of uncertainty", I suggest you look at the clouds which Trevor Constable generates with his etheric vortex generators, clouds he moves from 'A' to 'B' precisely, as engineered — regardless of theoretical or philosophical arguments. What lies ahead is often an uncertainty, such it has been for all humanity over the aeons. This has never stopped pioneers into new areas of endeavor, and hopefully never will.

MAXWELL'S DEMON

I notice a recent Peter Lindemann

article which started out with solar power and ended up with heat pumps, or engines.

I recall reading something long ago which someone might be interested in. It was about the fellow who took a stream of air, channeled it into a box, shook it up, and bled off hot air from one end of the channel, and cold air from the other end.

I don't have too good a memory of the article, but I think that his contemporaries, not knowing that cold air weighed more than hot air, decided that he had caught and forced a Demon into the box to separate the hot air from the cold.

So the invention, named after the inventor Maxwell, was called Maxwell's Demon. I think it was referred to by a long German name also.

It also did not involve chemicals like CFC's. Perhaps he got the stream of air from bellows from a pipe organ, or a blacksmith's forge.

In any case, I would think that an intake fan of some sort, channeled through a pvc pipe to a circular flat box could duplicate Maxwell's air centrifuge, with hot air coming from the center of rotation of the air, and the cold from the outside.

I suppose we would have higher pressures available now than they did a couple hundred years ago, and could get more of the air of the desired temperature out now than Maxwell could.

This might be of interest to people who live in places where the wind blows a lot, or with power, for auto air cooling.

Or perhaps it is too simple for anyone to make any money from it — no compressors, radiators, cfc's. I would be interested in any comments.

Dennis Kier
Carson, California

An excellent file on "Maxwell's Demon" is available from Rex Research, P.O. Box 19250, Jean, Nevada 89019 (catalog \$2). I haven't seen this material in years, but recall it was based on two vortices which spun off from a central air feed, creating a temperature polarity.

PSYCHOTRONICS & RADIONICS

I quite enjoyed Peter Lindemann's article in the Sept-Oct 92 Journal about Radionics in gen-

eral and the SE-5 in particular. I too have considerable time and research in this field and find that my view is quite different from Peter's. I would like to discuss a few points. As an artist I have found that adding contrast seems to help bring a picture into better perspective. I agree with Peter that "words" are and have been a source of confusion in this experimental field. Words like "broadcast", "treat" and "diagnose" have proved the undoing of many researchers. Words are meant to serve us not separate us. And words do change in meaning. They evolve as ideas evolve. It is a shame that the words Radionics and Psychotronics could cause enough of a rift to destroy meaningful contact between two respected research organizations. I happen to be "one of the people at the USPA" and my understanding of the term Psychotronics is contained in the definition that is part of the USPA Mission statement.

What is Psychotronics? The USPA defines "psychotronics" as the science of mind - body - environment relationships. This is an interdisciplinary science concerned with the interactions of matter, energy, and consciousness.

I know from personal experience that the USPA acts as a forum for all kinds of Psychic Realities. Radionics is only one of many subjects. As a presenter I am keenly aware of how little practical radionic research is presented at the USPA as well as other conferences. We are trying to remedy this by sponsoring a yearly pre-conference "Radionics School". Journal of BSRF also includes Radionics as only one of many subjects of inquiry.

The term Radionics is itself somewhat confusing. My understanding was that the word radionics was coined from the word radiate to describe Dr. Abram's first observation that "all matter radiates. . ." We now believe that the radiations that Abrams detected were actually patterns or fields rather than secondary radiations of the physical disease. This is an important concept to understand. The subtle fields, the patterns which are "tuned" by rates set on a radionic instrument, may actually manifest the physical form.

Our culture has looked so long and so intently at the physical world

or realm that it is difficult for us to see beyond. It is a very exact and limited view. The spiritual aspect of our world and our being are assigned to Church on Sunday and a few holidays. Some of us are simply not satisfied with these two extremes.

I think a sensitivity to the spiritual nature of things should be as great as the awareness of the physical. Too often, I think, when we use a radionic device we attempt to use it on a physical level in a physical way. We forget that it is a tool that only interfaces with the subtle fields.

I cringe when I hear the words "treatment," "diagnose" and "broadcast" in connection with radionic research. These words continue to confuse and misrepresent the "operation of a radionic tuner," in my opinion I think we must be sure the words we are using truly represent what it is we think we are doing. I prefer to use the words evaluate and balance.

I am somewhat amazed at Peter's description of the SE-5 Biofield Spectrum Analyzer. I am not sure how to take this description after discussing with him at some length his method for clearing ORANUR with the SE-5. I firmly believe we each operate within the bounds of our own concept of reality. It's important to define and clarify the way one views things but it is equally important to understand that your reality is not absolute even for yourself.

My reality views the SE-5 also as an extraordinary piece of equipment. I have full confidence that the rates set on the computer are

output as ASCII codes to the SE-5 circuit which are translated to resonant patterns which are spontaneously set into the subject under study. These patterns then affect the subtle fields according to their inherent patterning or intent. The rates carry intent inherently. I feel a rate or setting is a type of code, a name for an idea, object or place - and this "name" exists in the collective consciousness.

Malcolm Rae, when asked to define a radionic instrument, stated: "A radionic instrument is, therefore, an instrument for measuring whatever unit is employed in radionics and/or for controlling in the basis of data obtained by such measurement".

With our fixation on the physical some students tend to empower the radionic instrument with communicating and reasoning power. They still experience positive results using rates and programs because these settings carry information inherently. I feel the finest instrument lies within the individual and that it is this sensitive "instrument" we are "training" or with which we are becoming consciously connected. The two reasons I use the SE-5 are 1) to interface objectively and specifically the data fields I am investigating and 2) after developing a series of settings designed to support the holistic subtle bodies, I release that program to the SE-5 to resonate or "set" it into the subject's subtle field. I do not have the time nor the inclination to "hold" the program until it is picked up by the subject's subtle fields.

In Peter's reality all of this process I call "balancing" seems to take place within the etheric circuitry of the radionic instrument. In my model the balancing occurs within the holographic data fields of the subject. After much research I also believe if conditions are appropriate the subtle fields will manifest a more balanced psychical field response and that is why I study radionics. It is a process of interaction between matter, energy and consciousness.

Lutie Larson
Little Farm Research
993 West 1800 North
Pleasant Grove, Utah, 84062

MORE FROM THE USPA

Would like to clarify some of the issues you raised in Peter Lindemann's recent "Fizix Korner" article regarding U.S. Psychotronics Ass.

I was present at the original conference in 1975 convened by J.G. Gallimore who called it "U.S. Radionics Congress", and all subsequent meetings except the 1977 one. We began to formally organize at the 1976 meeting. It was agreed that the term 'Radionics' would not and did not cover adequately all the ranges of interest covered by the group. In addition it was noted that 'Radionics' in the U.S. was 'illegal' according to the F.D.A., and to adopt such a term when incorporating as a Non-Profit Corp. would be unwise. Several names were discussed, none of which seemed to 'fit'. The terminology Psychotronics was suggested, but since its definition was unclear, we then defined it in our own terms, as follows: "The United States Psychotronic Assn. defines psychotronics as the science of mind-body-environment relationships, an interdisciplinary science concerned with the interactions of matter, energy, and consciousness".

The USPA does differentiate between Radionic and psychotronic devices and other modalities. We have conducted 'Beginners Radionic schools' for several years. I show all the various types of radionic/radiesthesia devices, describing their functions, and the basics of Etheric energy, how to use a pendulum and/or rub plate.

It would seem you took USPA to task for "flying under a different

EXPLORE

NEW DIMENSIONS

Formerly *raum & zeit*, the only independent professional journal in the German and English speaking countries which deals with the fields of medicine and physics. One of the numerous goals of *EXPLORE!* is to bring the orthodox and unorthodox worlds together for the benefit of all.

Subscribe now to a quality journal presenting the latest research into shifting paradigms... a wonderful gift idea!

Call today or send to: *EXPLORE!*, P.O. Box 1508, Mount Vernon, WA 98273
206-424-6034 · Fax 206-424-6029 · 1-800-845-7866 (orders only)
One year subscription \$59.00 (USA) \$75.00 (Foreign Surface)
\$100.00 (Foreign Air) MasterCard or Visa

flag" other than Radionics. But the Radionics you define as 'ONLY ETHERIC' is a limiting case. As you stated, the original device by Dr. Albert Abrams was totally etheric, with the patient directly in the 'loop'. But the moment the patient is not in the direct loop, then other modalities may come into play. Remote effects by Radionics devices which occur in 'real time' (at the same time) would seem to preclude Etheric effects which move very slowly, Reichenbach measured the flow rate at 0.3 ft per second. Radionic effects were noted in experiments by Marcel Vogel in 'real time' over 3000 miles distance, thus another type of modality must be operative other than only Etheric; unless you allow that Etheric energy has a SCALAR component at either velocity 'C' or above which you term "goofiness". Chaos theory, fractals, and scalars which you deride as "goofiness" are only attempts by those who have actual technological education to apply mathematics to our field, and to develop paradigms that help explain the phenomena. Once the mathematics becomes established, then real engineering can follow. That these paradigms are in a continual state of development is true of not only the 'standard' academic view of physics, but also of psychotronics (which is inclusive of Radionics).

Chaos theory describes nested orders within orders of information or patterns; THAT IS EXACTLY WHAT ETHERIC PATTERNS ARE! Have you seen the 'Ultimate Atom', or Anu described by Leadbeater and Besant in the book "Occult Chemistry"? There are ten whorls of energy, which make 2½ turns on the outside and 2½ turns on a return path up the center; the whole of which is heart shaped. Each one of the single whorls, is really a coiled spring, the first outside layer has 1680 turns, and each single turn has another energy field coiling, at right angle, seven turns per that one turn. And this goes on for seven levels! THERE ARE NESTED ORDERS WITHIN NESTED ORDERS!!! Each of these whorls respond to different sounds, colors, radiations, electric and magnetic fields and a mysterious third electric force.

The Etheric field as described by Theosophical writings is a part of the physical level of existence, having seven levels. They are: solid, liquid, and gas; then four Etheric levels called #1,2,3,&4. The E1, E2, E3, & E4 are fundamental particles that make up protons, neutrons etc.. At

the E2, E3, and E4 levels, the various configurations form the sub-strata for all physical elements! There are more sub-strata types or possible combinations than you can possibly dream of, and yet we do not have a suitable quantitative detector! The 1951 edition of Occult Chemistry also describes what PRANA is; similar to the central globule of oxygen which has seven 'ANU' but with a slightly different arrangement of + and - and that each ANU is colored as the rainbow, red, orange, yellow, green, blue, violet, indigo, with the outside shell as pink. It enters the spleen chakra where it is centrifuged into it's appropriate meridians/organs. Alice Bailey describes the 2nd & 7th rays as the creators of Prana; all that is alive has Prana flowing through it's system! Don't confuse Reich's Orgone with Prana, it is Etheric but of a totally different nature; there are multitudinous types of etheric forms and energies.

I would agree that a 'true' Radionics device does, if built properly, resonate the Etheric patterns when 'tuned', and that a beginner has a much better likelihood of getting 'stick' with a good Etheric engineered device. But in reality, the radionics device is only 'training wheels' on a bike; as one becomes more proficient, you can go to the SE-5 or even way past that as the 'Grand Dame' of Radionics, Frances Farrelly, has proven; she uses a clip board with a block of paper and a small patch of formica glued on the upper corner as a rub plate. Or take Ann Johnson who, when I had bought my first Radionics device and was being shown how to use it, the instructor asked if she wanted to try, why yes she said. But within a few minutes, she said "OH shoot, I can do this easier", and then proceeded to write a series of numbers down on a piece of paper that her pendulum had indicated to her. We 'tracked' her treatment (using just numbers of a piece of paper) with the Radionics device and found her treatment to be just as efficacious! Just her mind and numbers were enough to get measurable results! IT IS THE INTENT OF THE OPERATOR THAT IS THE MODUS OPERANDI! The radionics device is only a hammer, and it doesn't build the house, the carpenter does!

STRANGE MAGAZINE

FRINGE SCIENTISTS

Wilhelm Reich
Nikola Tesla
Jack Parsons
Jacques Bergler

AERIAL ANOMALIES

UFO Occupants
Falls from the Sky
Ancient Astronauts
Cargo Cults

FORTEANA

Cryptozoology
Underground Mysteries
Kirlian Photography
Time Slips

INCREDIBLE ODDITIES

The Crystal Skulls
The Vinland Map
Archaeomalles
Crop Circles

WEIRD SCIENCE

Death Rays
Free Energy
Electrotherapy
Plasma Effects

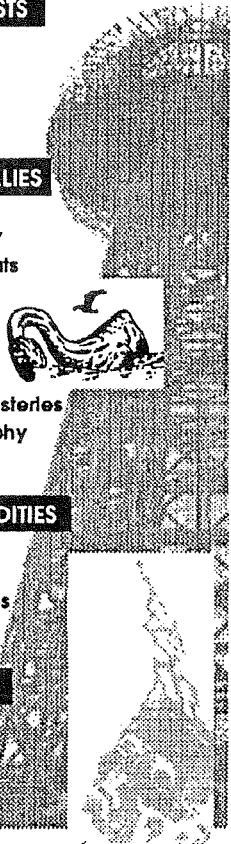

For five years STRANGE MAGAZINE has been bringing its readers an open-minded look at the mysterious world of Strange Phenomena. Each bi-annual 64-page issue contains fascinating first person strange encounters, in-depth investigations, documented reports, and fascinating articles by top-notch investigators of the unexplained including John A. Keel, Loren Coleman, Mark Chorvinsky, Jerome Clark, & Vincent H. Gaddis.

Send check or money order to:
STRANGE MAGAZINE:

PO Box 2246, Rockville, MD 20847

4 issue subscription—\$17.95 (\$22.95 Foreign)

Sample Issue \$5.95

Please charge my: VISA Mastercard exp. date

NAME _____ card number

ADDRESS _____

CITY _____ STATE _____ ZIP _____

When the 'treatee' is within the physical proximity of the device, then the Etheric patterns are dominant; there are many such devices and circuits. The beautiful book "Biocircuits" by Leslie & Terry Patten in which Lindemann's work is cited is of course an excellent example. The Edgar Cayce "batteries" and gold solutions are another example of persons being in the immediate loop of Etheric energy flow, laying on of hands, therapeutic touch, etc. Incidentally, when our local chapter was building our own devices, I sent several pounds of silver solder to the then major manufacturers to replace ordinary lead/tin solder that they were using; and has all others had used up to that point! I understood the import and reasons! Any one building a 'True Radionics' type device must understand what each and every material does and how it affects the operator (this has been discussed many times at our radionics schools)

On a capacitive type (Hieronymus type) there is a 'treat' switch which turns on an amplifier, and inverts the "signal" 180 deg. Most of the times you 'treat' on rate, rarely you select a different rate. Now in the event that a specific organ is over-functioning, you turn on the treat switch, check the amount of time to treat, and after the organ reading will have come down to normal range. The exact same procedure is used when the organ is under-functioning, the same rate, turn on treat switch, get the time, after, check the amplitude and it has risen up to normal. By using they identical conditions, one can cause the resultant reading to either up or down by the intent of the operator!

You mentioned Malcolm Rae briefly, there in my opinion is the closest true tuning to mother nature's system. The Fundamental ray as described by Abbe Mermet and Pierre Bease can be dowsed, and one can use a Bovis meter stick to get length. You can also get secondary, third etc. rays. The DeLamar Camera used copper sulfide crystal's fundamental ray to calibrate the proper orientation of the fields; when Marcel Vogel had the camera in his San Jose lab, he also used the copper sulfide calibration scheme, the ray on the film is the same as the funda-

mental ray for that material!

I think Tom has done a beautiful job with the *Journal* since he took over, it is vastly improved. You have done excellent work, and you are certainly entitled to your own views, but you have presumed our position, and that is not warranted.

I note with interest your reply to the Bulletin Board letter by Dorotheos C.E. Cody of your editorial and am in concurrence with Cody's comments. But there must be a balance between the total Reductionist and the 'Wholistic' views, because both are correct. And the USPA conferences has always had both the Esoteric and the 'Hard Stuff', we stand with one foot on the land, and the other foot is 'On The Water'. There will always be those who 'can't see the forest for the trees', but then most of mankind is in that position. Each of us grow at our own rate and path.

Sincerely yours,

Bob Beutlich, Pres. USPA

2141 Agatite, Chicago, Illinois 60625

Thanks Lutie and Bob for your points of view which you no doubt believe in firmly. We acknowledge the vast amount of information on this field held and disbursed by the USPA. However, we steadfastly maintain our position that Radionics is the science of the energetic radiations either forming or emanating from material substances and is separate and distinct from psychotronics, and not a subset thereof. Neither is it necessarily psychic, but it does lead the way to higher Spiritual Laws.

When placed in specific arrangements, specific materials create specific effects in the subtle energy fields surrounding living entities. This is best exemplified by the single wire Radionic tuner as used in Ruth Drown's basic equipment, yet it reaches much further into building alignment and structure, clothes, the very structure of our lives as it pertains to our spiritual (not psychic) advancement. The intelligence of the life force radiates from any piece of matter whether or not the human mind is involved.

As you say Bob, "a 'true' Radionics device does resonate the Etheric patterns when 'tuned'." Well, what we're talking about here is 'true' radionics—what else is there? I would agree that a 'true' Radionics device does, if built properly, resonate the Etheric patterns when 'tuned'. But I don't accept the snail-speed 0.3 ft per second as the speed of the etheric, rather that measurement probably describes some sort of ectoplasmic flow — the densest etheric currents in the life body. The etheric

energies transmit instantaneously universally, for this is the "framework" of manifestation. If you wish to borrow terms from mathematics such as "scalar" you are most welcome, but that term has been so abused with goofiness like "scalar waves" that we intentionally avoid it so as to not confuse our work with misinformation.

As we have pointed out on numerous occasions, Ruth Drown trained her operators to *not allow their psychic energies to interfere with the TRUE RADIONIC PROCESS!* Yes, when Radionics energies are sent at a distance to the subject modalities come into play above and beyond when the subject is physically connected — but I see no evidence they are psychic energies. This is a function of the Chemical Ether (aka the Tone or Number Ether) as clearly delineated in Trevor Constable's *Cosmic Pulse*. But psychic energies can be focused through Radionic equipment, hence making such a psychic 'lense' under this specific circumstance — and not as a general rule of radionic behavior.

Now the word 'intent' can be construed in many ways. Of course the intent of the operator of any tool is of the essence to accomplish a job. That does not imply that one's psychic ability will move a hammer to drive a nail, though such could *theoretically* be accomplished psychotronically. A radionic instrument is a tool which can be used to manipulate subtle forces, and when used psychotronically it ceases to function radionically.

To illustrate our point that the workings of a computer, as in the SE-5, cannot be termed 'radionic' in any sense other than as in a sub-material ghostly realm we need only to look at the source of such things as occult atoms, quarks & electricity. Evidence indicates that the occult vision of Charles Leadbeater was cultivated and sustained through pederastic relationships with young boys in his charge (see *The Elder Brother — A Biography of Charles Webster Leadbeater* by Gregory Tillett, Routledge & Kegan Paul, 1982). Leadbeater's was no doubt an authentic occult vision, but into shadow worlds and not the dynamic worlds of life. He slowed the atoms down to an *unnatural state* and then viewed them. In a Scientific review of all the evidence we should note his vision, but with the caveat that he looked beneath matter in an unnatural state in his Occult Chemistry work. Quarks are merely patterns seen when matter is destroyed at extremely high rates of charge. They are on the destructive, decay side of nature and there is no evidence that they are any sort of 'building block' (if there is such a thing) of Nature. Quarks are seen beneath matter in an unnatural state. Yes, Leadbeater's Occult Chemistry was vindicated in part by the theory of quarks, but look at where this work emanates from! As

Gustav LeBon has shown, electricity (as we generally understand it) is the result of the disintegration of matter—yet it can be a useful tool if used properly. It is beneath matter. (From what source does computerized “radionic” equipment draw its force to create effects in subtle energy fields? From decaying matter transformed to electricity. The Pathoclast was analog, but it did use electricity to *amplify* its signal for broadcast, a practice used by others e.g. Hieronymus, UKACO, etc.) Our orientation here is to look ABOVE MATTER, but we are aware we can go the other direction if we choose. This is not to rule out the penetration of minute biological processes by means such as the Rife or Naessens microscopes, as this is a view into matter and not beneath it, and quite important to our present course of endeavor, but not all-encompassing. Studying natural phenomena, including the properties of matter, is important. Putting matter into an unnatural state and expecting answers to the great questions of manifestation appears to be poor technique.

So what this all boils down to is the etymology of words. Just because someone with apparent authority tells you that Chaos consists of order are you going to believe them? Chaos is defined as “complete disorder.” Michael Theroux’s article this issue puts this more into perspective for those who have been fooled into thinking that chaos is order (and slavery is freedom!). The order that people are seeing in alleged “chaos” is actually representative of the True Order of Nature, and not the false order of inertial physics now pervading every aspect of modern life. True Chaos is

Pandemonium (actions attributed to the ancient god Pan) and will cause most people to PANic — hence the necessity to attempt to “order chaos”.

Psychotronics implies psychic energy interacting with some sort of instrumentation or equipment. Radionics implies instrumentation or equipment dealing with radiations — in this sense the subtle radiations of stable matter and not the hard nuclear radiations of decaying matter. One can call radionics and psychotronics whatever they choose within a closed group, but simple understandings of the roots of the words and their etymological origins will explain all to the public at large, and they should be the ultimate receivers of this information if the world is to transform to a higher sphere.

The controversy concerning whether or not the SE-5 Biofield Analyzer is a “true” radionics device centers on the question of whether or not the ASCII code (computer language) functions as a physical structure in space for the etheric forces to resonate in. This is the central issue. Here is why we at BSRF feel it does not. With real radionic equipment, once the tuning structures are designed and built, an empirical method is used to discover the specific settings at which the etheric resonances appear. This is how rate systems are developed. With the SE-5, on the other hand, the operator may simply type in a word or phrase and the device tunes to the subtle counterpart of that *IDEA*. The ASCII code is a system of symbolic and numeric characters that have been assigned arbitrary values by its designer. The code embodies no inherent values. No provision has been made to discover how

specific etheric patterns may interact with the various characters as they exist independent of the visual display. The function of it seems unrelated to radionic tuning as we understand it. The ASCII code began in the mind of its originator and is purely a symbolic representation of the ideas it is used to express, based on a mathematical formula that the computer logic can operate on. Radionic tuning structures, by contrast, allow etheric forces to resonate with the radiative emissions from the matter by physically embodying them. The SE-5 appears only ca-

pable of tuning to the *idea* of the radiative emissions from matter, since its ASCII code structures can only symbolically represent a tuning and cannot embody it except by the “agreement” of the operator. This is why we say that its operation depends on the intent of the operator.

The next question is philosophical: Are “ideas about radionic tunings” and “radionic tunings” the same thing? Some people have thought so. Malcolm Rae referred to his equipment as “thought simulators.” To be sure, the two are similar. On the other hand, Rae did not call his equipment “thought duplicators”, and we should be very clear that a simulation is *not* the real thing. It should be obvious that thoughts are not radionic tunings, even though they seem to function similarly within the very narrowly defined circumstances of subtle energy analysis. While on Spiritual/Existential levels of reality, the causative concept of a thing (idea) and the appearance of the actual thing may be simultaneous, here on the finite/experiential level of reality, the two are definitely separate and distinct.

The SE-5 might best be called an “ideonic tuner”, but it is not truly radionic. In spite of this, it remains a versatile, ingenious and effective tool for subtle energy analysis, in the hands of a competent operator. It should also be noted, that we at BSRF are not against the SE-5 or similar instruments. We are simply trying to understand what it is, how it operates, and what its relationship is to other equipment. We’d love to see verification of its effects through scientific protocol.

Prana, Od force, Orgone, Ether, etc., are all terms for the Life Energy in its many aspects. What is meant by “Etheric but of a totally different nature”? There is only one Nature and it is formed of grades of ether — non-physical prematter driven by active intelligence — as described in the Spiritual Sciences (such as in Anthroposophical circles), work oriented towards looking *above* matter and backed up by actual research (see **The Cosmic Pulse of Life** by Trevor Constable, **Metal Power** by Alison Davidson, **The Etheric Formative Forces in Cosmos, Earth and Man** by Guenther Wachsmuth, Rudolf Steiner’s Scientific Courses, all available from BSRF, for a specific introduction to what we term the etheric sciences).

Rather than awaiting some “new” mathematics to engineer radionic equipment we need only look to Nature’s structure for our most important lessons. The ancients understood the basis of radionics and the ruins of ancient temples scattered about our planet point to radionic activities of a more refined approach. The “new science” as some are labelling the slow emergence of vitalism into inertialistic science, is really the only true

TESLA’S EARTHQUAKE MACHINE

A new book, by Walter Baumgartner and Dale Pond, presents new technology based on SONIC VIBRATIONS produced by a simple device - The Tesla Oscillator. In the oscillator described, a RESONANCE EFFECT can be observed with accumulative effect - vibrations would destroy the apparatus if uncontrolled. Experimentation done by Tesla and Walter Baumgartner on the basic principles are taken and expanded. Clarifications are added from Keely’s work on principles of vibration and other orthodox sources.

Perfect bound, 160 pg., many drawings, illustrations, and shop drawings for building your own oscillator. Send \$75.00 plus \$4.00 shipping & handling to:

Delta Spectrum Research, Inc.
P.O. Box 5307, Bella Vista, Arkansas 72714
501-855-3946

Science. It has always been around, one just needs to open their eyes. Active work on delineating the etheric is afoot globally. Trevor Constable's weather engineering leaps all the philosophical hurdles as to the existence and/or composition of the ether and puts it to active accomplishment. Nick Kollerstrom, whose work we presented last issue, is actively demonstrating the influence of cosmic forces upon earthly matter and his book **The Metal Planet Relationship - New Studies In Celestial Influences** is due for release soon. So we're not waiting for any "new" mathematics or theories, though Nature is "ever new" and by awakening to Her we can understand what is called the "New Knowledge". BSRF represents active work, and if a new theory appears it will be based upon empirical observation of physical experiments, with the subjectivity of the experimenter just as important.

We expect the public at large to make their own decisions as to the quality and usefulness of the information put out in this field. It is hoped that they maintain a discerning eye on everyone. If anyone engages in public activities in any field they should assume there will be critics — we sure have ours.

This publication is our voice to our constituency and we say it as we see it, knowledgeable that the field is bigger than us all, and keeping in mind that there is always something to be learned. It should be the mandate of anyone disbursing information to be accurate, precise, and perceptive enough to grasp the whole of the picture. We can only try.

YAHOO TO BSRF!

Each time I read from a Borderland Journal, I am grateful to Riley Crabb for turning the Journal and ALL over to you. The Bulletin Board is usually the first thing I read — so with Vol. XLVIII #6 in hand I'm prompted to write an enthusiastic Yahoo to You for your masterful reply to the letter from Dorotheos Cody. I loved it. Well done.

I am like some of your other readers Tom, in that my intellect isn't up to a real understanding of a lot of Borderland Journal material — more-or-less, enough can and does seep thru the cracks to BE well worth the subscription. Thanks to you and Alison for your dedication and brilliance.

**Judy Beard
Dinosaur, Colorado**

Thank you for reading and keeping an alert mind. I'm honored to be editing all these researchers and always willing to learn from them. I wish I understood all we publish!

TESLA'S AUTOMOBILE

I suppose this info from the following newspaper clipping appears in some book about Tesla. I suspect this electric motor was based on the same principle as Tesla's resonator. Is it possible that the two rods received minute currents or electrical input from the atmosphere, and that Tesla's box combined these so that one would reinforce or amplify the other, and so that this amplification process would build up until there was enough electrical output to drive an electric car?

I can imagine two currents combining in a reinforcing way, but I am not sure I can imagine how the electrical energy would build up, unless the energy was stored for release, like a battery. Did some of the vacuum tubes serve as storage batteries?

Whatever Tesla did, the principle must have been simple, if he could just build the gadget out of a few standard parts.

**Sincerely,
Old Nick**

THE ELECTRIC AUTO ALMOST TRIUMPHED — Power source of '31 car still a mystery, Dallas Morning News, January 24, 1993

Not long ago, Texas Sketches told the story of Henry "Dad" Garrett and his son C.H.'s water-fueled automobile which was, successfully demonstrated in 1935 at White Rock Lake in Dallas.

Eugene Langkop of Dallas (a Packard lover, like so many of us) notes that the "wonder car" of the future may be a resurrection of the electric car. It uses no gasoline, no oil—just some grease fimmgs—has no radiator to fill or freeze, no carburetor problems, no muffler to replace and gives off no pollutants.

Famous former electrics include Columbia, Rauch & Lang and Detroit Electric.

Dallas had electric delivery trucks in the 1920s and '30s. Many electric delivery vehicles were used in big cities into the 1960s.

The problem with electrics was slow speed and short range.

Within the past decade two Richardson men, George Thiess and Jack Hooker, claimed to have used batteries operating on magnesium from seawater to increase the range of their electric automobile from 100 miles to 400 or 500 miles.

But it is a mystery car once demonstrated by Nicholas [sic] Tesla, developer of alternating current, that might have made electrics triumphant.

Supported by Pierce-Arrow Co. and General Electric in 1931, he took the gasoline engine from a new Pierce-Arrow and replaced it with an 80 horsepower alternating-current electric motor with no external power source.

At a local radio shop he bought 12 vacuum tubes, some wires and assorted resistors, and assembled them in a circuit box 24 inches long, 12 inches wide and 6 inches high, with a pair of 3-inch rods sticking out. Getting into the car with the circuit box in the front seat beside him, he pushed the rods in, announced, "We now have power," and proceeded to test drive the car for a week, often at speeds of up to 90 mph.

As it was an alternating-current motor and there were no batteries involved, where did the power come from?

Popular responses included charges of "black magic," and the sensitive genius didn't like the skeptical comments of the press. He removed his mysterious box, returned to his laboratory in New York—and the secret of his power source died with him.

A.C. Greene is an author and Texas historian who lives in Salado.

GOLD RECEPTION

Bob Mowat of Vivaxis discovered the gold receptor in the body is 1-1/2 to 2 inches below the navel — the

TESLA BBS

⊙ NETWORKING

⊙ RESEARCH

Electromagnetics
Wireless transmission of power
Transmutation
Biomagnetics

⊙ TEXT FILES

Nikola Tesla
Walter Russell
Tesla Turbine
Free Energy/Zero Point
Hyde/Swiss ML Converter
Keely Vibratory Physics
Cold Fusion
Gravity Experiments

⊙ PROGRAM FILES

Engineering
Math
CAD Tesla Coil Design

(719) 486-2775 Data

300,1200,2400 Baud (8,N,1)

Chinese "dantien", he says. (Silver receptor in sternum and oxygen receptor between eyes).

Richard Horton
Banning, California

MAGNET QUESTIONS

Congratulations on your new "Journal" for 1993 and best wishes for a great success. It sounds most interesting. As you may recall in former correspondence, I am a Senior at 93 years in September of this year - aiming for 100 plus. I am sending check for \$25 - not accepting Senior membership at \$15, the \$10 added is a small donation.

Blessings and a prayer to you and all at "Borderlands".

In your May-June Journal "Bulletin Board" Roy G. of Downy California asked for "Information please" about magnets. I waited for the July-August Journal for an answer so I would not ask the same, as you are so busy.

I bought 2 magnets, north and south, and one to wear around your neck. I am afraid to use them. Can you tell me how and if they are safe to use?

Genevieve Rivers
Fallbrook, California

Thank you for the donation and glad to hear you are going strong at 93! There has been a lot of information available over the years on using magnets to affect living systems, including our Vitic Research Project. Perhaps one of our readers is doing some current research and could submit some information.

CROP SIGILS

I like the recent articles about the crop circle by Dowell in JBR, and would like to suggest that we are dealing herewith someone else's language. The redundancy and inter-relationships between the various forms are among the basic characteristics of a language symbol code. Why the authors of these communications chose the wheat fields of presumably innocent British farmers as their arena is mysterious to me, as is the huge size of the format, unless they are frustrated by non-response and are yelling at us.

At any rate, if we start thinking of this in terms of language, some startling facts start jumping out of the wall. "Fig 8 - Silbury's Icons" in the current issue of JBR consists of 8 established symbols linked in a circle. Two of these symbols are clearly recognizable as heavenly objects: a crescent moon and a planet with three moons. The other symbols are mysterious, but we've seen them before especially the key-shape which is even included in the wearable psychotronic device. Could this be the Rosetta Stone? Is this a list of symbols (or words) for prominent heavenly objects?

In language learning, *thinking* about the symbol code is important, but must be repeatedly tested in a participatory exchange with other speakers. What would happen if we started talking back, not really knowing any of the rules yet, but presuming the existence of a live intelligence which wants to communicate at the other end of all this mysterious symbology? For example, consider this: Two of the symbols in the same example have apparently been garbled by the presence of a conductor (a metal feeding trough) in the field. What if we reconstructed the entire form in another place free of metals, leaving blank spaces where the garbled symbols had been? Would the missing symbols appear?

It is also possible that this same figure is an example of what Native Americans call a medicine wheel, and that the symbols refer to the directions of the compass. This would depend on the compass bearings which weren't given in the article. If it is a medicine wheel, it is the Rosetta Stone, because medicine wheel symbols are multidimensional, referring to directions, times of the day, seasons of the years, stages of life, colors, animal powers, spirit gifts, spirit beings, types of sensory perception, etheric elements, and personality types. The decryption of eight symbols that rich in meaning could lead directly to the cracking of the entire language code, if that indeed is what we are being confronted with here.

Mike Pettingill
US Naval Intelligence linguist and cryptographer, retired.
Kapaa, Hawaii

SEEKING MWO RESEARCHERS

My purpose in writing to you is to ask for your assistance in locating people or organizations here in Australia who are working with or experimenting with Lakhovsky's Multi Wave Oscillator.

My own inquiries here in Brisbane through the few contacts I have made, have proved of little value. I'm hoping that through your organization with its multitude of contacts, you may possibly be able to assist me with the addresses of some other interested parties here in Australia. As I travel a great deal, any addresses anywhere in Australia would be very helpful and greatly appreciated.

My interest in this field has really intensified over the past 18 months since I finally obtained a copy of Lakhovsky's "The Secret of Life" and your own excellent "The Lakhovsky Multiple Wave Oscillator Handbook" - thank you for your efforts in compiling this excellent publication.

I look forward to hearing from you in the near future.

Yours sincerely
John Murphy
Brisbane, Australia

SPACE DRIVE

In issue #4 of the Electric Space Craft Journal an article appeared called

THERE ARE NO ALIEN ABDUCTIONS!

and we prove it in

DEMONS, DOCTORS, AND ALIENS

by James Pontolillo

What he does prove will astonish you, infuriate you (because you've been lied to), and embarrass you (if you're guilty). A landmark, scholarly, powerful study that will silence for all time the fiction of alien abduction! UFO and alien supporters take note: INFO has thrown down the gauntlet of truth and challenged you to prove your assertions!

\$10.00 from

International Fortean Organization

Post Office Box 367
Arlington, Virginia 22210

The Morton Space Drive. In issue #6 Klaus Scheidt, wrote a story about an experiment done with that drive. It was an attempt to find out why powder vanished without a trace on the attracting end of the drive.

This gives you a brief glimpse into 20 years of research in which many unexplainable phenomena occurred. Although my drive has been exposed to the public 3 or 4 times, there has never been room to go beyond the most important points.

For instance I say my drive is propelled by Longitudinal Electro-Magnetic waves. What is the nature of LEM waves? Very little is known about them but from my experiments I can state LEM wave photons? are subject to the law of equal and opposite reaction, where transverse waves are not.

But the drive produced some really weird side effects. In one case the radio signal came back an hour after it was broadcast. In other cases the drive seemed to lose weight when turned on. The drive seems to stimulate all chemical reactions even biological ones. In another case a certain type of drive continued apparent thrust for 5 minutes after it was turned off.

This is my exploratory letter to find out what you or your readers might be interested in.

Truly,
Charles Morton
Stafford, Kansas

We are interested in working models and useful theories. You have apparently provided both—THANKS! Electric Spacecraft Journal, P.O. Box 18387, Asheville, North Carolina, 28814, is a very good source for borderland-type technical information, including experimental data. Check it out.

ACTIVE AUSTRALIANS

Greetings to you, and many thanks for BSRF! A "mag" we really enjoy and appreciate.

Last month here on the farm we held a most informative Workshop Gathering, with Bruce Cathie as main speaker, coming over from New Zealand. The aim of the workshop was to "bridge the gap" somewhat with the scientific viewpoint of the World Energy-Grid System and how it can be possibly used to enhance growth and stability in agriculture.

Much progress was made and I was amazed at the innovative ideas of some of the visitors.

However last year we had our worst drought ever here in Nt. Queensland, Australia, and so far a very mild, cool wet season.

The Robert Adams "Pulsed Motor Generator" Manual from New Zealand is circulating well in Aust. with many now under construction. This motor really does work, truly a breakthrough.

Do you know of any "Aerials in Agriculture" in the USA that are specifically tuned to the "Earth Harmonics" - and if so how are their results etc., apart from the California Orange Grove setup?

Yours Most Sincerely
Robert Martin
Queensland, Australia

ORGONE MATERIALS

Where do I find steel wool in grades of .000 - .0000, just might do an experiment in the capture of "orgone energy".

Enclosed is \$15, so that I may have many pleasing moments in the search between the pages.

Sincerely
Loren Stone
Wickenburg, Arizona

Your local hardware store should be able to order this for you if they don't have it in stock. And we're glad we have provided you with some pleasing moments - we could all use more of them!

MORE EARTH ENERGIES

I have just become a country dweller, way out in the "boonies" (boon docks). This farm that I have moved to has some very potent "up spouts" of EARTH ENERGIES! It is "weird terrain" with some very interesting possibilities!

We certainly have here an "ACUPUNCTURE POINT" on the planet earth! I plan to do some experimentation with this "uprushing energy" column and if we get palpable results I will inform you about it!

I have just read Nov-Dec 92 issue and it is Great! Will the revelations never cease?!!

Sincerely
Art Khalsa (The Old Firewalker)
Ely Iowa

The revelations *never* will cease - we promise!

LIVING CELLS

I submit this essay for your consideration inasmuch as you claim an openness to all sources.

These bodies are constructed of living cells.

Crystals are generated in the blood, they are amplifiers but of what? Magnets are now found in the brain. So with a measurable amount of electricity generated by each cell and amplified by the crystals and magnets, is it not time to explore what the "word construct" brings forth by using "Mantras"?

Why, an electro-magnet with crystal amplification?

We seem or appear to be found in the "word construct" "materialism" only.

Perhaps the mystical may then turn out to be more practical in our Quest towards "The Etheric Body". We cannot serve two masters. The material world so called, with its deceptive senses, or the etheric realm with its high abstractions? As not completely exposed to our satisfaction. You know from your explorations that: all civilisations abandon the material plane as soon as the superior realm becomes available, and Quickly!
Respectfully,
F.M. Moore
Bryte, California

KIND WORDS

Keep up the fine work! Your publication gets better and better every issue.

Steven Patascher
Scottsdale, Arizona

We couldn't do it without people like you, Steven. Thanks for participating!

THANKS!

These letters, comments, received listings and contacts represent only a fraction of the mail we get at BSRF. We are always working to keep up with the tremendous flow. There is enough material for a monthly, but barely enough time to get this quarterly out. We also field dozens of phone calls per day, from all over the world - there is incredible interest in our work. We have no regular funding other than what we take in on sales of books, research reports and videos. Handling this is time consuming, but it keeps us going and we enjoy it. We thank you all for participating, so keep those cards and letters coming!

RECEIVED

A listing of books, video and audio tapes and other assorted materials received here at *Borderlands*. Longer reviews of selected materials may appear in future editions.

PHYSICIAN'S QIGONG COURSE

by Dr. G. K. Knowlton. This is a well laid out course covering the secrets of Qigong, i.e. how to develop, circulate and promote chi (qi) energy, from basic postures to advanced techniques. Includes: Medical Qigong — the cultivation and projection of the body's vital energy for healing; Shaolin External Qigong — a closely guarded method of projecting chi from your hands.; Yinjinjing — an ancient technique to strengthen and repair the muscle and tendons, useful in therapy for severe orthopedic trauma; Taiji Qigong — for overall health and chronic diseases; Chin — awakening mental powers, generate great strength and will from internal, non-muscular powers; The Five Miracle Points; Kiatsu Whiplash Treatment; The Five Rites of Rejuvenation; and more. While this course is designed with the practitioner in mind, it is useful information for anyone. These are simple Qigong techniques which can be learned in 15-20 minutes each. The chi force can be generated in minutes with these simple exercises. What impressed me about this course was that it is designed for the practitioner to teach the techniques to his/her patients. How many health practitioners do you know that teach you exercises to do at home to keep well, thus potentially eliminating the necessity for further treatment? This course retails for \$395, but *Borderlanders* can get it for \$295 for thirty days after you receive this publication. Also available is a Buddha Burning Palm Course for \$99.95, which includes a manual, video and a special herbal liquid for external use, applied to the hands, called Dit Da Jow. The Buddha Burning Palm Course will enable the user to send a powerful chi flow to their hands for experimental purposes. You will be able to leave a palm print on another person through two telephone books, simply by slapping the top book! For more information or to purchase the course contact: Dr. G. K. Knowlton, 5555 East 71st Street, Suite 6100, Tulsa, Oklahoma, 74136; phone (918) 496-8011

THE COMPLETE LARRY SPRING!

The ever-prolific experimenter and writer, Larry has compiled all of his books and articles into a single volume. From inner space to outer space Larry attempts to solve the riddles of physics and along the way provides many eye-opening and exciting experiments. Someday his Electromagnetic Spherical Theory will be given its due. Until then, be the first on your block to be able to measure the size, shape and speed of electromagnetic energy. This phonebook sized volume is \$50 and is available now through BSRF.

LOUISIANA MOUNDS SOCIETY NEWSLETTER:

This issue #56 - March 1, 1993, features Burrows cave art, Louisiana's mounds, Lost prehistoric city in Ireland, Ancient symbols and writing, Book reviews, News & more. Subscription info from 3330 Eastwood Drive, Shreveport, Louisiana, 71105, 318-869-0365.

STEAMSHOVEL PRESS #7,

an interesting issue containing good interviews with Jonathan Vankin and John Judge, and articles: Wilhelm Reich in Vienna by Jim Martin; Science as Credo; JFK and the Nazis; The Promis Threat (about people-tracking software stolen by the U.S. Dept. of Justice — *shame on them!*); and more. Very interesting reading, \$4/issue (\$5 foreign), from Steamshovel Press, 5927 Kingsbury, St. Louis, Missouri, 63112

RADIO TESLA: THE SECRET OF TESLA'S RADIO AND WIRELESS POWER

by George Trinkaus. "In clear English, 66 illustrations, and a minimum of math, this booklet details the peculiar radio technology of Nikola Tesla". Just in, looks good — \$6.50 from High Voltage Press, 4326 SE Woodstock #489, Portland, Oregon, 97206.

THE GODS OF EDEN by William Bramley. Another interpretation of the sinister alien conspiracy from the usual patriarchal world-view. \$5.99, Avon Books, New York.

an idiot's guide to the i ching by roderic sorrell and amy max sorrell, published by bio-ching publishing, box 1172, Bisbee, Arizona 85603. The title sez it all! But others will no doubt be interested as well.

SACRED MOUNTAIN MINERALS

— A naturally chelated organic compound from an ancient sea bed, containing 76 minerals and 188 trace compounds. An exceptional additive (like rock dust) for potting soil, vegetables, shrubs and trees. For information and prices write S.M.M., P.O. Box 1367, Fort Bragg, California 95437, or call 707-964-8170.

CONTACTS

A listing of researchers seeking information and research resources on where to find information.

* **Brian Scott**, 7 Maybud Road, Duncraig, WA 6023, AUSTRALIA, (phone 09-447-1143) is searching for useful information on suction and implosion turbines. He has all of the BSRF implosion files and is seeking further information which can be put to practical use.

* **Keith Rector**, 276 Nichols Drive, Santa Cruz, California 95060, (phone 425-0562), is looking to contact people in the Santa Cruz area with similar interest in Life Energy, Orgone research, etc.

* **INFO REQUEST** — Would any of you readers out there be able to make available to me copies of **ENERGY UNLIMITED** issues 16 through 19. I would even settle for good xerox copies — as I would rather have something than nothing, and as many of you would probably be hesitant to sell the originals. I am willing to compensate anyone for the expense of making copies of these magazines, and for mailing them overseas. If anyone can help please contact: R. Ashley Falk, 10 Orchard Street, Avondale, Auckland 7, NEW ZEALAND

* **Electric Power Generation Methods:** Data exchange including experimentation on vast file of working devices. Contact: Alexander Peterson, 11200 Gravois-C, St. Louis, Missouri 63126

* **INDEPENDENT UFO NETWORK** is holding a UFO conference titled *UFOs: fact, fraud or fantasy?* at Sheffeld Polytechnic, Main Building, Pond St. Sheffield, S.Yks, England on the 14th & 15th of August 1993. Contact: Stu Smith, 15 Rydal St., Burnley, Lancashire, BB10, IHS, England. phone 0282-24837.

Murphy's Law CIN

Computer Information Network

Information is the fuel of dreams!

Subscription BBS featuring:

Online Browsing Library

Internet Resource Library

Unique and Comprehensive

Alternative Science Library

Shareware Library

Mind-expanding Alternative Science

Debate Areas

Complete Borderlands Catalog Online

and much, much more!

We support every person's right to freely think!

Murphy's Law CIN (707)923-4897

24hr CIN, Multi-Node

1200 - 14,400 Baud, ANSI/ASCII/VTxx N,8,1

For more info call (voice) (707) 923-4186

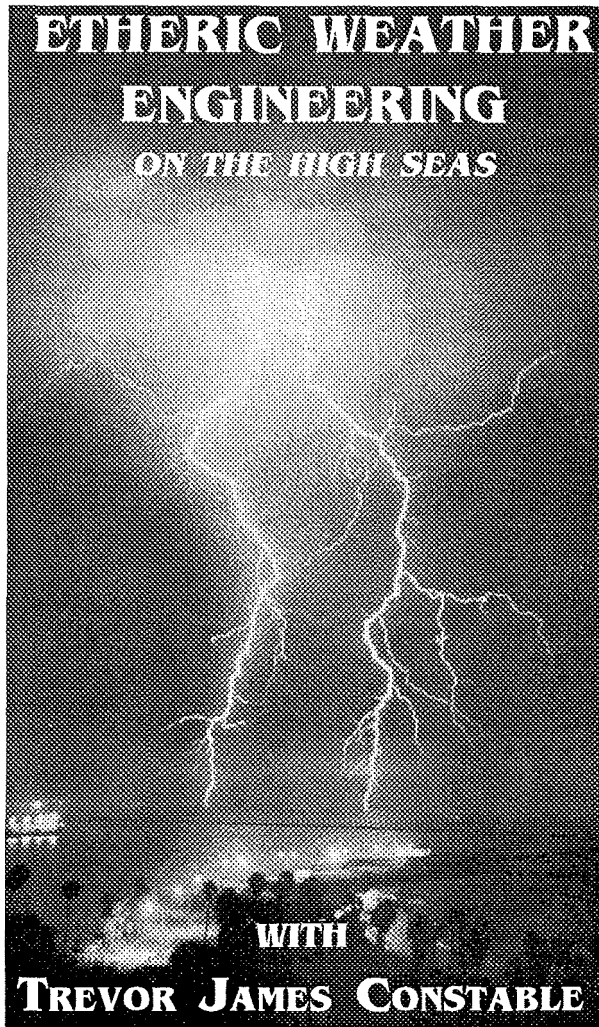

WEATHER CONTROL is one of humanity's primal visions. For millennia, weather control has been the domain of shamans, kahunas and warlocks. Modern chemists, physicists and meteorologists have tried to extort rain from Mother Nature via crude chemical and electromagnetic assaults. They have demonstrated mainly their own alienation from basic natural forces.

The revolutionary weather control of Tomorrow is demonstrated with startling elegance today, on this tape, by one of the legendary pioneers of borderland science – Trevor James Constable. The distinguished author, aviation historian and U.S. Merchant Marine electronics officer, takes you with him on shipboard to that mighty laboratory of maritime Nature, the North Pacific Ocean. He uses simple geometric apparatus, with no radiation or chemicals. Constable objectively demonstrates that the ether – unnecessary to classical physics since Einstein – is indeed an incredibly subtle yet tremendously powerful **PHYSICAL FORCE**. This is just as Sir Oliver Lodge postulated a century ago, holding that we are so totally immersed in this force that we have no consciousness of its presence. Visible empirical work on the high seas has now removed the perceptual barrier Sir Oliver Lodge described.

The ether is no longer an elusive historical phantom. Before your eyes, the ether undergoes a spectacular resurrection. Deluges descend in response to the pioneer's application of the ether's laws. This happens despite **HIGH BAROMETRIC PRESSURE** and a full range of rain-negating parameters.

The ether as a physical force is shown to be physically accessible – via mobile geometric forms and orientations. The gossamer-subtle ether is demonstrated to permeate and influence the atmosphere. Time lapse video tape provides visible, compelling proof of this reality, the master key to controlling and engineering the weather, and therefore ultimately, **CLIMATE**.

Constable shows additionally, with the documentation of U.S. government weather maps and shipboard radar, that rains can be engineered inside vast Pacific high pressure systems. Such anomalous rains are induced via implosive etheric vortices initiated by direct human intervention. These rains persist within horizon distance for hours on end, as the SS Maui rushes across the Pacific at 22 knots.

Constable then demonstrates with stunning directness, that his simple etheric vortex generators penetrate thick marine steel. *He induces local rain from within the ship's hull!* Radar and US Navy weather maps confirm the mind-boggling truth.

Two and a half decades of quiet pioneering produced the revolution in physics and technology portended by the scenes on this videotape. Enlightening and entertaining for all.

ETHERIC WEATHER ENGINEERING ON THE HIGH SEAS

with Trevor James Constable, 72 minutes, VHS, order number V0043 \$33.00

Postage & Handling - add \$2.75 / first item, plus \$1 each additional item.

California residents add 7¼% Sales Tax. Visa/Mastercard orders call (707) 986-7211

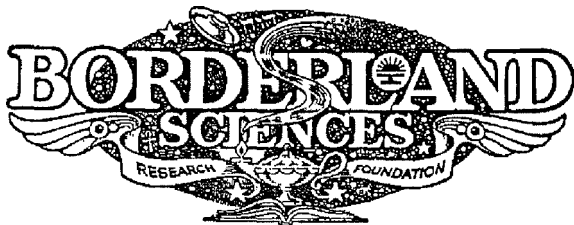

P.O. Box 429 ★ Garberville ★ California ★ 95542

**FORWARDING POSTAGE GUARANTEED
ADDRESS CORRECTION REQUESTED**

<p>BULK RATE US POSTAGE PAID</p> <p>Tarpon Springs, Fla Permit No. 37 Post Code 34689</p>
--