

BORDERLANDS

THE CROSSROADS OF SCIENCE & SPIRIT

1st Quarter 1993 Volume XLIX, Number 1

<i>Inner Power</i>	1
<i>Planetary Chemistry ..</i>	7
<i>Water Energy.....</i>	24
<i>Radionic Truths</i>	34
<i>News & Views.....</i>	46



BORDERLANDS

THE CROSSROADS OF SCIENCE & SPIRIT

Borderlands is a quarterly publication of Borderland Sciences Research Foundation, P.O. Box 429, Garberville, California 95542, Phone 707-986-7211, Fax 707-986-7272. Contents © 1993 by BSRF.

Thomas Joseph Brown
Editor-in-Chief

Alison Davidson
Associate Editor & Production Assistant

Peter Lindemann & Michael Theroux
Associate Editors

Borderland Sciences Research Foundation was founded by Meade Layne in 1945 for the purpose of investigating into realms normally beyond the range of basic human perception and physical measurement. B.S.R.F. is a non-profit scientific and educational foundation directed by Thomas J. Brown. Meade Layne directed from 1945 to 1959. Riley Hansard Crabb, from 1959 to 1985.

Borderlands originated as Meade Layne's **Round Robin** in 1945 and was changed to **The Journal of Borderland Research** in 1959. It was changed to **Borderlands** in 1992. **Borderlands** is an information nexus for thinkers and doers on the frontiers of science and awareness.

Borderlands is available to members of Borderland Sciences Research Foundation. BSRF Membership fees are:

\$25/year, worldwide, Regular Membership
\$15/year, Senior Citizen Membership
\$50/year, Supporting Membership
\$100/year, Sustaining Membership
\$1000, Lifetime Membership

Membership entitles you to **Borderlands** for the duration of your membership term.

Borderlands is sent bulk mail in the U.S. and ISAL overseas. Single issue \$6.95

The main fund-raising activity of BSRF is to act as an educational clearing-house for information, and to actively seek donations to fund our activities.

All published materials are presented for Informational and Research purposes only. Authors are solely responsible for the information and opinions they present. This material is not to be construed as expert opinion or medical advice, it is research into the **Borderlands...**

OUR NEW LOOK!

One measures a circle beginning at any point. As we begin our 49th year of publication we metamorphose to a new state of being. The masthead has changed over the years, but inside you will still find the same current of inquiring minds, at the forefront of vitalistic thought—a pleasant reprieve from the onslaught of materialistic impulses pervading many souls on this planet. We ask not that you believe what is on these pages, but that they act as a stimulus to advancing and organizing your individual thought processes. Thank you.

Tom Brown, Editor

CONTENTS

THAT WHICH IS ETERNAL IN US MUST BE AWAKENED

Tom Brown ... 1

DEVELOPING THE KOLISKO APPROACH

Nick Kollerstrom ... 10

FIND ACU-POINTS WITH YOUR COMPUTER

Stephen Gibson ... 16

I AM ENERGY

Larry Spring ... 18

A POSSIBLE ALTERNATIVE TO BATTERY POWERED VEHICLES

Ed O'Brian ... 20

DESIGN ECOLOGY - PART II

Michael Riversong ... 24

RECORDING TELLURIC SIGNALS - PART II

Gerry Vassilatos ... 27

MY SEARCH FOR RADIONIC TRUTHS

Book Review by Alison Davidson ... 34

TOYS OF JUPITER?

THE JEFFERSON MARKET GEOACTIVE ZONE

Eugenia Macer-Story ... 38

THE PAPER DOCTOR

Book Review by Peter A. Lindemann ... 41

THE LAKHOVSKY MWO: BACK TO SQUARE ONE

Peter A. Lindemann ... 43

2ND HUNGARIAN CONFERENCE ON PSYCHOTRONICS

Report by G. Belovari ... 42

NEWS 'N VIEWS FROM THE BORDERLAND

The B.S.R.F. Bulletin Board ... 46

THE INNER FLOWS

The origins of our lives is in the fusion of two cosmic polarities, a microcosmic reflection of the origin of the physical universe in the fusing of darkness and light. When we are gestating in the womb there is a basic energetic and nutritional flow from our mother through the umbilical cord into the navel. One belief attributed to the Taoist sages of the Orient is that the primary energy flow in the fetus goes from navel towards the perineum up through where the spine is forming, over the crown of the head and down the front of the body, through palate and tongue (which are usually pressed together in the foetus to connect the energy meridians) to the navel where the cycle is renewed. This is the primal energy flow, antecedent to the nervous system, which our body emerges from. It is called both the Small Heavenly Cycle and the Microcosmic Circulation (or Orbit). Dr. Rudolf Steiner stated that in order to understand the realities of the starry heavens one must also comprehend the complement—human gestation in the womb.¹ This reality was well known to the Taoists, though their teachings were kept secret for many thousands of years.

True esoteric methods are not complicated.

Mantak Chia

THAT WHICH IS ETERNAL IN US MUST BE AWAKENED

by Tom Brown

When we are born we begin to absorb vital energy through our noses and our nutrition through our mouths, and for the most part people lose touch with the original energy center in the navel. Our consciousness becomes centered in the head and the organs are left to fend for themselves amidst the 'pressure' of reality. In the West our exercise programs generally focus on the strengthening of muscle tissue and we wonder why someone who eats well and exercises can drop dead of a heart attack or other organic disorder. In the East specific teachings have survived which allow one to reconnect with and increase their original energy, to circulate it in the microcosmic orbit and thence move it outward through the entire acupuncture meridian system. But to work into this one must be able to first clear and focus the mind.

THE TOTAL MIND

The function of consciousness is generally relegated to the cranial grey cells but they are really part of a greater whole. Our brain is the nexus of the central nervous system and is the seat of our discursive—onlooker—consciousness, but not that of the total human consciousness. Our entire body encompasses that. The heart, nexus of the vascular system, has been acknowledged as a seat of consciousness by many diverse cultures worldwide, and the solar plexus has been termed the 'abdominal brain'.

We have a special consciousness for each organ of the body. Moods and emotions well up from our entire being and directly impinge upon the conscious action of the individual. When we lose touch with our total consciousness there can arise a wide range of degenerate health conditions related to organic dysfunction. Western medicine replies by providing specialists in particular parts of the body.

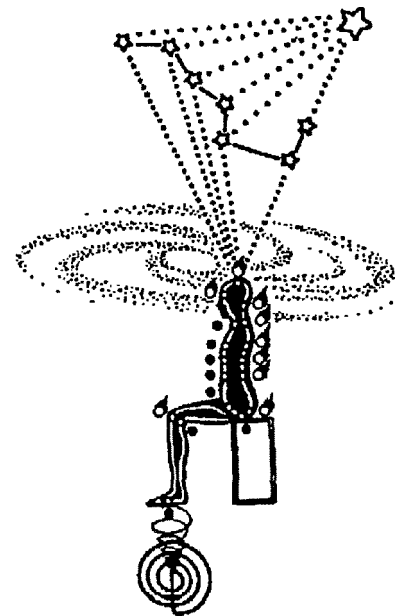

The Microcosmic Orbit
Reconnecting with the Original Force

THE METAMORPHOSIS OF AWARENESS

A characteristic feature of the most ancient of philosophies of which we have any knowledge is the belief in the creative influences, æons or gods in relation to the measurement of time. It was understood that every man contains within his nature elements which directly correspond to each one of the gods, the proportions depending on the time and place of his birth. The same notion was extended to human societies, which have a life cycle like that of an individual, and time itself was seen as a procession of gods or cosmic forces, regulating the course of events both throughout the day and over long periods of time.

John Michell²

Rudolf Steiner indicated that as the sun moved through various stages of the zodiac in the past, the focus of consciousness moved through different parts of the body.³ In what he termed the First Post-Atlantean Epoch the sun rose in Cancer in the spring and this related to the thorax. Humans sensed and reacted through their breathing and were in direct touch with the elemental world. Perception depended on breathing changes — as one met various people, or observed diverse objects, their breathing would change accordingly and awareness arose from these perceptions.

In the Second Post-Atlantean Epoch, when the sun arose in Gemini in the spring, the symmetrical aspect of consciousness developed and humans gained an awareness of the cosmic aspect. The inward (symmetrical) complement to this was perception in the abdomen—contact with the deep atavistic forces.

In the Third Post-Atlantean Epoch the sun rose in Taurus in spring and this related to the larynx forces. Thus developed the connection between the spoken word and objective reality. These words were not abstract concepts, but words of power which connected one to the cosmos. Our abstract languages of today are but a pale shadow of this direct speech.

The Fourth Post-Atlantean Epoch dawned when the sun began to rise in Aries in spring and this related to the upper head region. The Cosmic Mysteries were the thought patterns of this age and the great temples of Greece and Rome describe this original connection which gradually degenerated into the materialism preceding the fall of those great civilizations.

The Fifth Post-Atlantean Epoch, which Steiner claims began in the 15th Century, was brought on when the sun rose in Pisces in the spring and this represented the foot forces, the binding of humans to the earthly forces. But those incarnating within this—our present—period have the greatest potential for spiritual advancement of their human souls. In Dr. Steiner's conception as the physical body (individually and planetary) grows old the etheric body grows young.

While I realize that there are differing schools of thought on the timing of the astrological æons—many feel that the age of Pisces began 2000 years ago, hence the symbolism of Ikthus the fish and the *vesica piscis* in relationship to Christianity—the concept I am trying to bring forward here is the progressive awakening of that which is eternal in humans, that which is connected to the cosmos, the innate perception of the microcosm connected to the macrocosm which is deadened by our modern world view. Within all manifestation is a living, spiritual essence which came before and will outlast the physical.

Dr. Steiner presented the concept that as the physical body grows old the etheric body grows young. This finds congruency with esoteric theories on the polar natures of spiritual and material time streams, as well as the practice of Taoist Yoga. The aim of Taoist Yoga is to gestate an immortal being within so that at the time of death it is born as a vehicle for the soul to travel in at will. Without a vehicle reincarnation is imminent, unless the soul has been damaged or degenerated through unhealthy practices—in which case the basic components return to their respective elemental oceans—or partially connected segments reincarnate with plenty of troubles to see them through their karma.

IN TOUCH

Is it possible to get in touch with our entire organism and build our physical and spiritual strength from there? The answer is a resounding yes—if you have the discipline and moral aptitude to devote yourself to such a project. If humanity is ever going to metamorphose beyond our present degenerate culture we need to be able to control our own energies and not be controlled by external impulses—especially those presented through manifestations of the electrical forces.

The Taoist system provides a complete system by which this may be achieved. In the more advanced stages of Taoist Yoga the external influences of the cosmos are only taken in as needed and are no longer pushing and pulling one subconsciously—one can release oneself from control of astrological influences!

In the ancient Taoist system each major organ has a positive and negative emotion ascribed to it, as well as representative colors and animals—deep symbolism whose meaning can only dawn through internal awakening. The lungs hold sadness, grief and sorrow, and are the seat of righteousness, surrender and courage. Their color is white, their animal is the white tiger. The kidneys hold fear, and are the seat of gentleness. Their color is dark blue and their animal is the deer. The liver holds anger and is the seat of kindness. Its color is green and its animal is the dragon. The heart holds cruelty and impatience, and is the seat of joy, honor and sincerity. Its color is red and its animal is the pheasant. The spleen holds worry and sympathy, and is the seat of fairness and compassion. Its color is yellow and its animal is the phoenix.⁴

While the oriental symbolism of this system will not appeal to all, one's organs still need attention—it should be a priority to get in touch with our organs, know them, feed them with vital energy. In our modern age people go to great lengths to be 'sexy', with clothes, makeup and social action, but this is all an external illusion, style with no content. Real sexuality arises from vibrant organs—the sperm and ovum are the quintessence of the organic system and their energy can be cultivated, preserved and transformed for nourishing the system and awakening the spirit within.

It was reported in the 'news' that sperm count in men has dropped dramatically, an obvious discernment considering the disconnection of modern consciousness from the physical and the general degeneration of the life body of the earth. Vital force is the ultimate healing agency—we are creators, interiorizing the universe within each of us. We can connect ourselves with the universe—spiritual advancement comes with healing.

Psychic Centers (Chakras)

SAHASRARA-PADMA
Crown Center
Seed-Syllable: OM

*In the Tibetan System
conceived as One
Center*

AJÑĀ-CHAKRA
(between the Eyebrows)
Seed-Syllable:
half or short A

VISUDDHA-CHAKRA
Throat Center
Element: Ether as
substrate of Sound.
Seed-Syllable: HAM
Color: White
Form: Circle

ANAHATA-CHAKRA
Heart Center
Element: Air (motion)
Seed-Syllable: YAM
Color: Grey-Blue
Form: Hexagram

MANIPURA-CHAKRA
Navel Center
Element: Fire
Seed-Syllable: RAM
Color: Red
Form: Triangle

SVADHISTHANA-
CHAKRA
Abdominal Center
(4 finger-widths below
the navel)
Element: Water
Seed-Syllable: VAM
Color: White
Form: Crescent

*In the Tibetan System
combined under the
name Sang-Nā*

MULADHARA-CHAKRA
Root Center (in the
perineum).
Element: Earth
Seed-Syllable: LAM

Physiological Counterparts

BRAIN
(Pituitary Gland)
Volitional Nerve-system

Cerebro-spinal Nerve-
system

MEDULLA OBLONGATA
Non-volitional Nerve-
system

PLEXUS CERVICUS
Respiratory System

PLEXUS CARDIACUS
Circulatory System
(Blood-vessels)

PLEXUS
EPIGASTRICUS
(Solar Plexus)
System of Nutrition

PLEXUS
HYPOGASTRICUS
Inner Organs of Secretion
and Reproduction

Generative System

PLEXUS PELVIS
(Sacral Plexus) which
controls the outer organs
of generation.

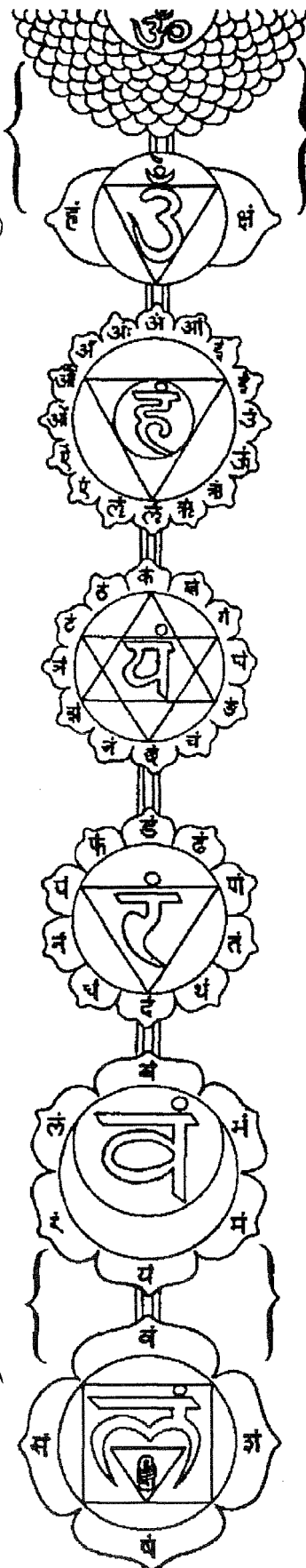

THE CHAKRAS

No description of the chakras can be given except to state that they are minute, like a small cell and all have a tiny spot which is like an eye, entrance to a duct. They are invisible to the naked eye. The fanciful pictorial patterns by Indian artists can be ignored, but now that we are familiar with the recent progress in genetic research and that the information of a thousand volume encyclopædia can be contained in one sperm head, we can easily understand the fabulous nature and power in each chakra.

Shri Dadaji Gurudev Mahendranath⁵

Modern medical research has discovered that after certain physical portions of the brain have been removed the body can still commission functions related to the removed section. The theory of morphogenetic fields can account for situations like this, but as profound as that theory appears to modern consciousness, it lags far behind basic esoteric knowledge of the interior “wiring” of the body. In the west we have been exposed to books, such as Charles Leadbeater’s **Chakras**⁶, which describe specific energy centers of the body. A standardized, easily workable science of activating the chakras has not readily been available. However, many systems teach physical and mental techniques to stimulate these etheric vortices into action. Merely focusing on the chakras, while expanding awareness, does not constitute a thorough system for developing and integrating the higher bodies, though it is a step in the proper direction.

One researcher who has experienced the chakras subjectively through yogic practices, as well as through scientific measurement utilizing instruments of his own development is Hiroshi Motayama. He developed two instruments, the AMI (Apparatus for Measuring the Functional Conditions of Meridians and their Corresponding Internal Organs), and the Chakra Instrument. The AMI was “designed to measure the initial skin current, as well as the steady state current, in response to DC voltage externally applied at special acupuncture points ... these special points are ostensibly the terminal points of meridians where the Ki energy either enters or exits the body.” The Chakra Instrument was “designed to detect the energy gen-

Chart of the Chakras and Related Physical Systems²⁷

erated in the body and then emitted from it in terms of various physical variables ... it is designed to detect minute energy changes (electric, magnetic, optical) in the immediate environment of the subject." The Chakra Instrument is used in a room shielded from light and electrical fields. Research with these instruments has indicated the reality of the meridians and chakras.⁶ Besides measuring energies in the electromagnetic and optical bands, the human body also emits minute vibrations in the 6-12 cycles per second range, and there are vital energies which have not yet been measured with scientific equipment. Our bodies are dynamos of activity on a broad spectrum of wavelengths.⁷

The chakras can be understood as specific nexus points along the subtle wiring system of the body, and have also been related to the ductless glands. They are energy connecting points, but also much more. They can be stimulated through concentration and through certain tones—seed syllables—which must be pronounced correctly in order to be activated. The throat chakra contains sixteen 'petals', the first seven are a musical scale, the eighth is called *the venom of mortality*—these eight relate to our sound relationship with the world through speech and music. The ninth through the fifteenth are the seed syllables relating to the seven chakras which can only be pronounced after proper training. The sixteenth is called *the nectar of immortality*. In Taoism it is said that the thyroid gland in the throat controls speech, and when there is tension in that gland one has trouble speaking, though the tongue itself is connected to the heart.

The Tibetan Book of the Dead (*Bardo Thodol*)^{8,9,10} describes an archetypal trip through the memories stored in a portion of the chakra system. The peaceful deities are the path

through the energy relationships stored in the heart chakra and the wrathful deities are from those stored in the crown chakra, at the top of the skull. Various other entities encountered in the *Bardo Thodol* are the energy relationships with the connecting meridian and points between the heart and crown chakras. The god forms encountered are merely the cultural masks placed by the Tibetans on the energies we all encounter in life—each culture will have its own masks. You can find yours by getting in touch with your inner self.

People with near-death experiences have reported that they saw their whole life 'flash before their eyes'. This is because they are experiencing the totality of the stored memory in their energy system as it separates from the physical. This is the true source of karma, our energy relationships between our subjectivity and our objectivity. In some cultural traditions it is said that after death a person walks a path and has to face each person they met in life again. This is congruent to the Tibetan concept of the peaceful and wrathful deities. When we cross paths with others in this life we have time after the fact to consider the relationships. After we shed our clay suits we encounter the primary energy relationships which are then no longer grounded in the material plane. If one has learned from life's experiences then progress is inevitable in the ungrounded state. If one hasn't learned they are channelled back into the material plane to try and learn again. Such is the ever turning wheel of life. But once an individual takes full control of their own destiny they can consciously remove themselves from the cycle—but doing so entails a precise practice and not a philosophical state of mind.

It has been said that by simply being born as a *homo sapiens* does not make one a member of the human race. To become a

ELEMENTS AND STUPA

This chart shows the elements—earth, water, air, fire, and ether—as related to the stupa, a symbolic form of architecture describing the integration of the elements as chakras in the human form.²⁹

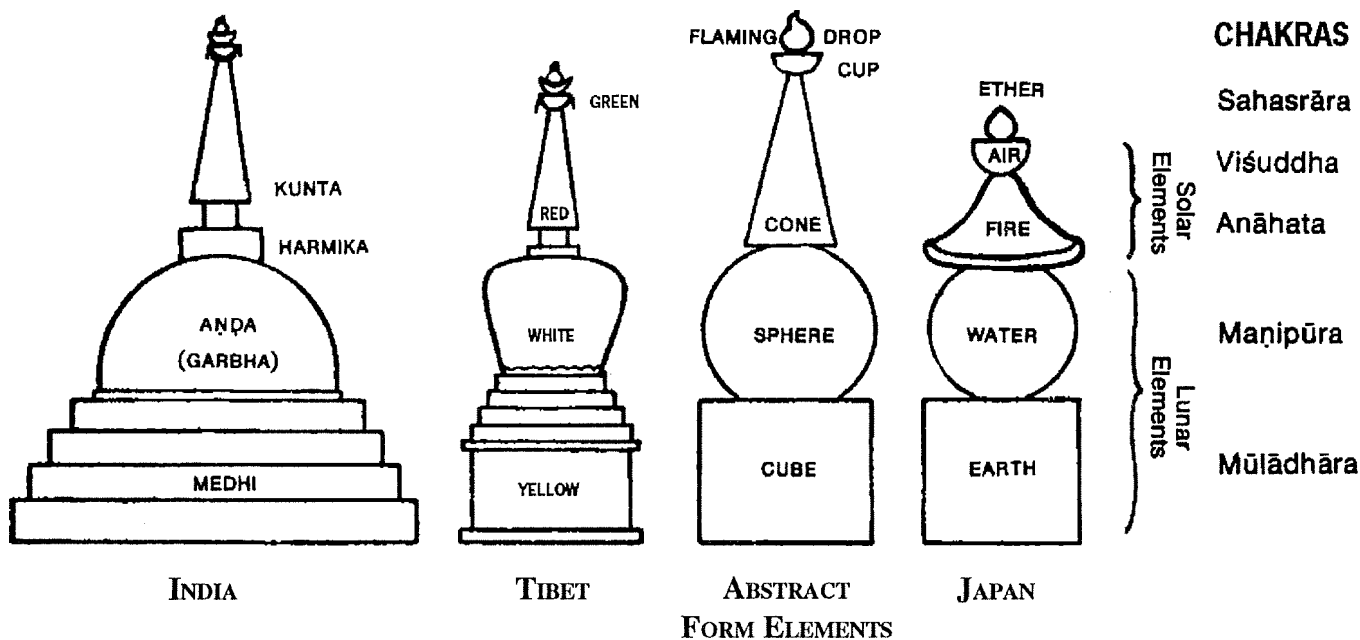

FIVE ELEMENT THEORY

The elements both nurture and oppose each other as they interact in manifestation.

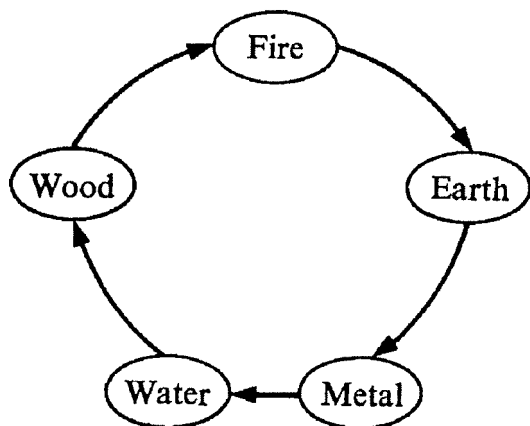

Creation Cycle

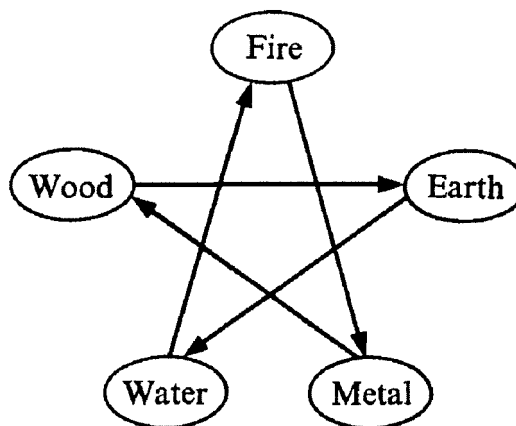

Controlling Cycle

member one must make a conscious commitment.¹¹ Each individual has their own path of commitment. It is destiny, but destiny can be altered or delayed by diverse modes of action.

FOUR OR FIVE ELEMENTS?

The Chakra system is pictured with seven chakras, the lower five being related to the elements as they have been considered in the Western alchemical tradition: Earth, Water, Air, Fire and Ether—Ether being the quintessence of the other four. Air and Fire are transposed along the Chakra channel to allow for the active arrangement of the elements into the physical body. The chakras have the same pattern as the Buddhist Stupa, a shrine built of the elemental flow in the body of the cosmos as reflected in the human body. This shows that the four basic elements were known and used as a basis for psycho-cosmic thought in the Orient.

However, in the Chinese culture we find an elemental system which has five elements: Earth, Water, Wood, Fire and Metal. In Chinese medicine these five elements are related to specific organs of the body: Lungs - Metal; Kidneys - Water; Liver - Wood; Heart - Fire; Spleen - Earth. These elements have a creation cycle and a controlling cycle and are a logical system relating to all aspects of life in Chinese traditional thought.

There does not appear to be a direct correlation between the two elemental systems, yet both are completely valid for the viewpoint they describe. They are views of different cross-sections and do not conflict. Earth, Water, Air and Fire are universal elements and exist in modern science as the states of matter, solid, liquid, gas and plasma. While no exact physical correlate exists for the Chinese five element theory it is quite useful in understanding the physical state of one's organic system.

ACUPUNCTURE MERIDIANS

Acupuncture describes the basic energy points and pathways of the physical body, like the ley lines of the earth, and this energy structure has been observed in western clinical research. Acupuncture meridians are energy lines which flow about the body, certain points on which connect to various organs and other

energy centers. The basic approach to acupuncture is described in many books, all of whom pretty much concur with each other.^{12,13} There is reportedly a esoteric form of acupuncture, in which certain secret points are touched by a chi master to simulate higher states of consciousness in the student. The student then can strive naturally towards the state which he has experienced thusly.¹⁴

In ancient China people paid their doctors to keep them healthy. It is said that if one got sick the doctor had to pay them back—certainly a system that should be brought back into use. Acupuncture was originally conceived as an inferior form of medicine, the best doctors would keep their patients healthy and not need to resort to mechanical manipulations of the energy meridians. Where manipulation was necessary they would manipulate it with their own energy, either mentally or with finger pressure. However, acupuncture has evolved into a well established medical procedure in Asia, and has gained a minimal level of acceptance in the West. One can even go to an acupuncturist using 'public aid' in California.

Some modern acupuncture techniques involve putting electricity into the energy meridians through the needles. The original form of acupuncture involved the energy of the practitioner—they were trained to project their force before they could use a needle to direct it. With the advent of modern approaches to understanding the human energy body has come the grave error of confusing the gross electrical forces with the fine life energies of the body. Keeping this misconception in mind will allow us to read deeper into modern researchers on the subject and understand more fully what is being sought.

Dr. Robert Becker has shown in his work that there is a primitive direct current energetic system which is directly related to the acupuncture system. The function of this system is to sense injury and effect repair.

"Pain transmission is one of the functions of the DC electronic data transmission system. The transmission of DC signals via actual current flow over transmission lines is subject to cable constants such as 'resistance'. In engineering practice, this is



The Governor Meridian

From the perineum up the spine to the crown of the head and down to the palate.

overcome by inserting into the line, at intervals, operational 'booster' amplifiers to restore signal strength and maintain intelligibility over distance. Since our data indicate that the operational signal levels of the biological DC system are in the millivolt and nanoampere ranges, one can predict the need for structures functioning as operational amplifiers along the channels of DC transmission. This analysis leads one to consider the acupuncture meridians as DC communication channels and the points as sites of operational amplifier location. If we are correct, the points should show lower resistance and higher conductance than non-point areas of the skin, and both resistance and conductance factors should show an organized field pattern around the point. The points should be discreet sources of direct current. They may demonstrate a polarity indicative of the direction on signal transmission and, when instrumented in series, the points should demonstrate propagation of signal. This concept offers an opportunity to objectively assay the system of acupuncture meridians and points in a scientific fashion within the framework of a viable theory. Such analysis has been in progress and our results indicate that approximately half of the acupuncture points studied exist as real, measurable entities with electrical characteristics as predicted by our theory.¹⁵

The acupuncture points show a resistance of around 50,000 to 100,000 ohms, as opposed to the normal skin resistance of about 1,000,000 ohms. Thus a basic acupuncture detector can be built based on this principle.^{16,17} Such devices have been built but

electrical sensitivity varies from person to person, and the cleanliness and moisture of the skin will vary between individuals. Hence, this is not a fully reliable approach and is not relied on by skilled acupuncturists. However, it is an excellent research approach to objectifying the reality. As mentioned previously, electrical stimulation of acupuncture points has also come into vogue, an inevitable result of the electrical world view impinging on the natural approaches.

The chakras are major points on the acupuncture meridian system—what Dr. Becker terms 'operational amplifiers'. There is sufficient physical evidence to support the reality of the acupuncture points and meridians. When these points and meridians are stimulated or blocked with various methods there is a definitive physical change in the body.

OPTIMUM OPERATION

It has been known in the orient for thousands of years that this energy structure can be kept at optimum operation through focusing the consciousness upon it — it is consciousness in its grander form. But one of the shortcomings of the oriental systems have been that those of western bent cannot always relate to the various gods and energies attributed to them. It must be understood that these godforms are merely the cultural masks, and that the Europeans lost touch with their original cultural masks and gained new ones with the advents of Christianity and the Industrial Revolution. But cultural masks are not neces-

The Functional (or Conception) Meridian

From the perineum up the front of the body to the tip of the tongue

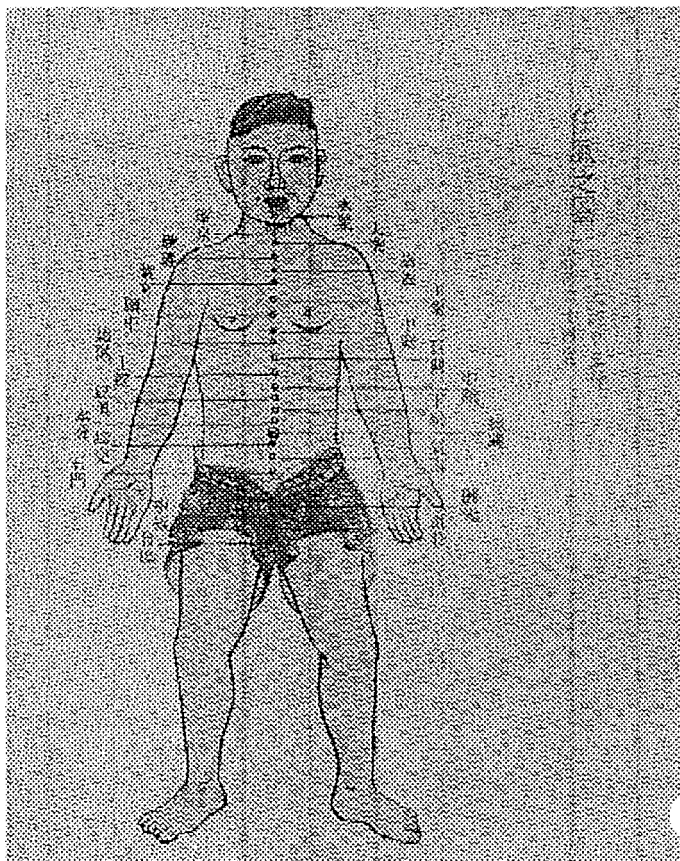

sary—there is an archetypal system that will relate to all humanity—there has to be, it only makes sense.

Various internal exercises have been available in the west for many years. Peter Kelder's **Eye of Revelation**,^{18,19} describes five basic exercises, termed 'rites', which stimulate the energy body into action. Borderland has been publishing these exercises since the early 1960's, and former director Riley Crabb related the various exercises to sections of the Qabalistic Tree of Life. Another version of these exercises are available in the book **Ancient Secrets of the Fountain of Youth**. The exercises are faithfully described in the book, but for some unknown reason the publishers arbitrarily changed the energy centers which are stimulated by the exercises to match their concept of the chakras.²⁰

In these books there is a sixth 'rite' for men to sublimate their sexual energy up their spine—but it is not a detailed exercise such as are found in the Taoist system—and there is no information on what women are to do. This shows that the origins of the **Five Rites** are no doubt authentic, but that the ultimate inner teachings were not given forth. Nonetheless, the **Five Rites** are an excellent exercise system, both physically and energetically, and are an important introduction to internal work.

Great caution should be taken in sublimating the sexual force up the spine. The excited male energy is hot and can cause physical problems if stored in the head. It must be brought down to the navel center after raising it up the spine. The unexcited energy can be stored in the head and adds greatly to the intelligence and life force of the individual. Naturally, women can also move their sexual energy through their meridians. This is one stage in Taoist Internal Alchemy.^{21,22}

The sexual energies are persistently drained out by activities of modern culture. Our hopes and desires—our entire life waves—are intertwined with their use or misuse. When one treads the path of implosion instead of explosion they are on the way to spiritual immortality.

INTERNAL ARTS

There has been a growing fascination in the West with the Oriental martial arts, Kung Fu, Chi Kung (*Qi Gong*), Aikido and Tai Chi, which focus on internal chi energy, and Karate, Tae Kwan Do and Thai Boxing which focus more on external physical training—though mental training is very important in most schools. Having read some of the translated sacred texts of the Orient I knew that there was an underlying energetic process behind the various martial arts, but for many years so little was to be found on exact procedure for full control of this energy. Fragments would appear

here and there in books, indicating that there were methods of rejuvenating the body and raising it to high levels of energy. In the mid 1970's the book **Taoist Yoga—Alchemy and Immortality** by Lu Kuan Yu (Charles Luk)²³ became available. It described in some detail the process of the Microcosmic Circulation, the act of moving ones chi energy through the two main acupuncture channels, the Functional (or Conception) meridian which goes from the perineum up the front of the body to the tip of the tongue, and the Governor which goes from the perineum up the spine to the crown of the head and down to the palate. By touching the tip of the tongue to the palate the two channels are connected and the energy is circulated from the navel up the spine and down the front to the navel again. From there the energy may be taken to other centers and transmuted into higher forms. Mr. Luk's book, while being quite revealing and an important work, was still a bit difficult to completely grasp and it left many questions only an experienced teacher could answer.

About ten years after that a Taoist master, Mantak Chia, began issuing books, the first being **Awaken Healing Energy Through The Tao**.²⁴ Master Chia's books are much more in detail and quite helpful to those who wanted to (or had to) practice without a physical teacher on hand. He has studied and mastered the entire Taoist internal system and is in the process of revealing it to the world. Workshops and classes are given and a listing of such can be gained from The Healing Tao Center, P.O. Box 1194, Huntington, New York 11743.

Master Chia's books
cover in very specific
terms
the

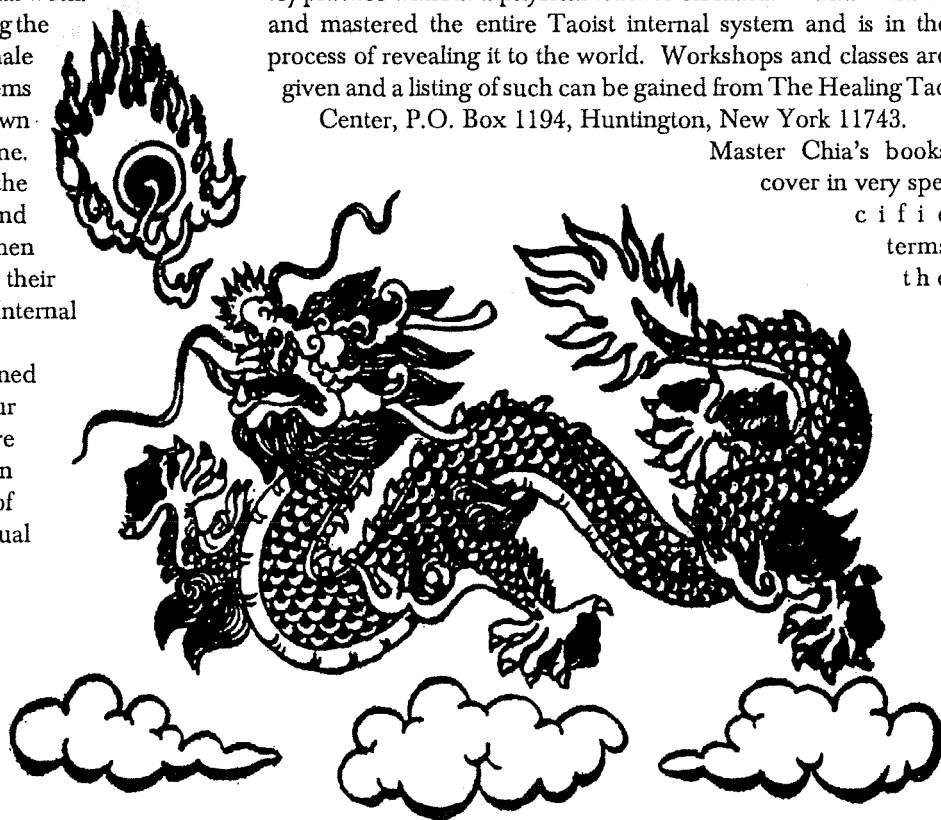

Dragon with Pearl

The Eastern dragon is not the gruesome monster of mediæval imagination, but the genius of strength and goodness.

The Dragon represents that which is common between the furthest depths of the soul and that which is beyond the outer periphery of space—across those borderlands which separate us from our origins. The pearl is the cosmic energy—the fusion of the five elements, flowing through all life—and is controlled by our developing consciousness through the breath. It can be circulated through the Microcosmic Orbit. The force goes where the consciousness goes.

energetic process of Taoist internal yoga from basic awareness of the energy, on through the entire internal alchemy, further on through an amazing healing system Chi Nei Tsang²⁵(Internal Organ Chi Massage), on through the development of the immortal fetus and release from the thralldom of the wheel of life. This is the first complete revelation of this extremely ancient system and there are centers springing up all over the world for those who want to learn it. It matters not in which form you worship, respect or deny the Supreme Universal Creative Intelligence—this is an energetic system of physical, emotional and spiritual health which can be applied by all humans to their personal benefit.

The Chinese National Chi Kung Institute began issuing a mail order course in the internal Taoist circulations in the mid 80's. This is a correspondence course with video tapes to complement. This teaches the same basic internal circulation of chi energy. Roger Hagood, the man who has helped bring much of this knowledge to the western world is the publisher of *QIGONG* Magazine (Pacific Rim Publishing, P.O. Box 31578, San Francisco, CA94131) which is an excellent source to keep track of this field of endeavor at present and the CNCKI can be contacted through them.²⁶

SOMETIME TODAY

In this day and age we are all concerned about our health and the prospects of degenerate disease. Our inner health is directly related to our outer health and the healing of the planet can only come about through a collective inner organization. Many people following the Western Esoteric Traditions have prejudices towards these oriental influences, yet we are all on the same planet and can learn from others' enlightened viewpoints. The Western Traditions will die out unless they are vitalized through a pragmatic approach towards cultivating our vital energies. Dr. Wilhelm Reich's discovery of the orgone energy provides a lynch-pin for the western scientific mind to begin to probe these areas, and Dr. Rudolf Steiner's many lectures provide further clues for a modern vitalistic approach to science and esotericism to emerge. Trevor Constable has presented a cogent overview of the Western Esoteric approach to the vital energies in *The Cosmic Pulse of Life*³⁰ which should be read by all who seek to understand the finer forces of nature and apply them to everyday life. But as westerners we are at the beginnings of discovering the vitalistic approach to the world, in the process of learning we can look to those of other cultures who have mastered the art of cultivating their inner force and connecting it with the universe. Through synthesis and metamorphosis we all grow towards a common goal. There are lifetimes of knowledge to be learned.

CHI PRESSURE

Proper breathing exercises are at the base of all of these methods. In *The Amazing Secrets of the Masters of the Far East*³¹ exercises are given for generating the vital force through breathing exercises termed *pranayama*. This book is a good introduction to the Indian approach to cultivating inner force.

One major purpose of the Taoist meditations is to increase the chi pressure in the system to reduce the possibility of disease entering the organism. Negative emotional energy is transformed to pure vital energy. Negative energy in the organs is vented off via various exercises such as the Six Healing Sounds.

The six healing sounds produce a special tone or word for each organ and vent out negative energy, replacing it with positive. Those familiar with Albert Abrams' research describing the origins of radionics will know that he based his original impulse on the 'percussive' technique, known from the middle

ages, where a person's abdomen would be struck with a mallet (lightly of course) and the quality of the organ could be readily assessed. As radionics developed it became known that by applying a specific etheric frequency to one's body an out-of-tune organ could be brought back to optimal operation. The six healing sounds thus allows one to operate their body as the radionics instrument. Once one has progressed past the physical plane equipment, the first stage of radionics, they move on to the higher levels – but this knowledge is vacant from all modern exoteric radionic schools of thought. In past ages the energies to keep the organs in full function were derived from temple structures and

The Chinese character above is pronounced as chee. There are three basic romanizations of the Chinese characters, Wade-Ciles - Ch'i, Yale - chi and Pinyin, officially adapted in mainland China in 1958, - qi. Its core meaning is 'murky air' and paired with other characters has many meanings, from the weather to emotions, including concepts relating to the life energy in its various manifestations.²⁶ The word *ki* is the romanization of the Japanese term, as used in the name of the energy art of Aikido.

mystery school ritual patterns. We are moving forward in time and the ancient Taoist techniques have come full circle to allow everyone—with whatever religious or cultural interface you prefer to use in connecting with the universe—to keep their own body in optimal health. This is the most basic and fundamental step towards any higher knowledge.

In the Taoist practices oxygen and chi are 'packed' into the fasciæ of the organs and the layers of skin. These days many people are aware of the importance of oxygenating the body, Borderlander Ed McCabe has travelled the world spreading this important information. There are many oxygen products and procedures for putting oxygen into the human system, either orally, rectally or by direct injection (of ozone) into the blood, and all of them seem to be of great benefit to the system. Using Taoist breathing meditations one can bring oxygen into the system on their own power and direct it to the place most needed. I have heard it said that deep breathing will not keep the oxygen in the system as long as taking an oxygen product, but this reveals an

ignorance of or a prejudice against proper energetic breathing exercises. You can learn to store it in your system, and you have the added advantage of having the chi energy stored with it. There is no life force in the bottles of oxygen carriers, just the oxygen itself.

CONTAINING THE POWER

All of us have an individuality that is developing—we are in the age of ego development (egotistical activities are signs of improper development). With the birth of the great totalitarian states, brought about by severely restricted energy flows in masses of humans, there comes an obvious conflict with ego development. This is a great ordeal of our age and many deal with it differently. The manifold impulses of our modern technological age have in many ways replaced the cosmic influences which have waned with the electrification of the planet. People are pulled this-a-way and that-a-way by advertisements and urges to consciously satisfy unconscious organ degeneration. Our vital energy is constantly being drawn out of our systems by the glammers used in advertising and subliminally integrated into automobile shapes and other 'consume more' products. It is of the utmost importance to develop and contain your own individual microcosmic world, for in that lies the correcting of the many external dysfunctions.

In order to keep some level of individuality people develop diverse styles of dress and action, and of course this gives great flavor to our world when these styles are an expression of a vitally active soul. There has arisen what are called 'modern primitives', people who tattoo and pierce their bodies for various reasons, to reach different states of consciousness from the endorphin rushes concomitant with such practices, to show their rejection of modern society, or to profess an individuality and sense of power in their own bodies (and tattoos and piercings have been used in various cultures over the aeons to coordinate the physical body with the energy body). These are outer expressions which vary from person to person and culture to culture, and no doubt can have a profound effect on the inner planes if used properly. But within us we all have the same organs, organized into a fundamental structure which provides us with life.

Externally the human race manifests as different racial groups, and there is that which is common amongst all and that which is different between each. Each race is an organ of the whole, and as we find many people suffering from disruption of the organic balance within their bodies we also find organic disruption within the body of the human race. The Taoist system may not be what you need or desire as an individual—yet it can provide important insights into the maintenance of the physical and energetic bodies. The Western Esoteric traditions are lacking in knowledge of the precise operation of the energy bodies—knowledge which was once probably inherent to human culture. Mantak Chia was raised as a Christian and believes that Christ was a master of the energetic sciences and has taken his place in heaven as an immortal. This state of immortality can be attained by anyone—it is an inevitability in the long run. In the short run we can advance on our own.

This article is an attempt to describe that which is a common expression of the eternal within each of us (and it has barely

scratched the surface of the available materials). It is too easy to find that which is different—each of us knows within themselves how they differ from the others—and through applying the lower end of the cognitive spectrum to this aspect we have come to our present world in conflict. It is by finding that which is common amongst us that we progress towards a harmonious, uplifting culture and discover that which is eternal in us all.

REFERENCES

1. **Course on the Relationship of Astronomy to the Diverse Natural Sciences**, by Rudolf Steiner, translated by Rick Mansell, edited by Fred Mathews, Rudolf Steiner Research Foundation, Redondo Beach, CA
2. **City of Revelation** by John Michell, Ballantine Books, NY, 1972
3. **Planets, Constellations & the Zodiac in Human Evolution**, a lecture by Rudolf Steiner, January 8, 1918, translated by Rick Mansell, Rudolf Steiner Research Foundation, Redondo Beach, CA
4. **Taoist Ways to Transform Stress Into Vitality** by Mantak Chia, Healing Tao Books, Huntington, New York
5. **The Fanra of Blowing the Mind** by Shri Dadaji Gurudev Mahendramath, Mandragore, New York, 1981
6. **Theories of the Chakras: Bridge to Higher Consciousness**, 1981, Theosophical Publishing House, Wheaton, Illinois
7. **Biological Anomalies: Humans I**, William R. Corliss, Sourcebook Project, Glen Arm, MD, 1992
8. **The Tibetan Book of the Dead**, translated by W.Y. Evans-Wentz, Causeway Books, 1973.
9. **The Tibetan Book of the Dead**, translated by Francesca Fremantle and Chogyam Trungpa, Shambala Publications, Boulder, CO, 1975
10. **Bardo Teachings - The Way of Death and Rebirth** by Venerable Lama Lodo, KDK Publications, San Francisco, CA, 1982
11. **Spiritual Scientific Medicine and the Healing Arts of Tomorrow**, Karl Maret, M.D., First International Borderland Sciences Congress lecture, 1990, BSRF, Garberville, CA
12. **Synopsis of Chinese Acupuncture**, W.C. Cheong & C.P. Yang, The Light Publishing Co., Hong Kong, 1985;
13. **Chinese Acupuncture Handbook**, edited and translated by Samuel M. Wong & I.W. Law, Light Publishing Co., Hong Kong, 1982
14. **The Book of Chinese Beliefs**, Frena Bloomfield, Ballantine Books, New York, 1983
15. **Electrophysiological Correlates of Acupuncture points and meridians**, Robert O. Becker, Electroenergetic Systems, 1976
16. **How To Build A Lie Detector, Brain Wave Monitor & Other Secret Parapsychological Electronics Projects**, Mike & Ruth Wolverton, Lab Books, Blue Ridge Summit, PA, 1981
17. **Find Acu-Points With Your Computer**, Stephen Gibson, *Borderlands* - 1st Quarter 1993, BSRF, Garberville, CA
18. **The Eye of Revelation** by Peter Kelder, BSRF, Garberville, CA
19. **The Five Rites of Rejuvenation**, video, BSRF, Garberville, CA
20. **Ancient Secret of the Fountain of Youth**, Harbor Press, 1985
21. **Taoist Secrets of Love - Cultivating Male Sexual Energy**, Mantak Chia & Michael Winn, Aurora Press, 1984.
22. **Healing Love Through the Tao - Cultivating Female Sexual Energy**, Mantak & Maneewan Chia, Healing Tao Books, Huntington, NY, 1986
23. **Taoist Yoga - Alchemy and Immortality**, Lu K'uan Yu, Samuel Weiser Inc., New York, 1973
24. **Awaken Healing Energy Through The Tao**, Aurora Press
25. **Chi Nei Tsang - Internal Organ Chi Massage**, Mantak & Maneewan Chia, Healing Tao Books, 1990
26. **QIGONG Quarterly**, Pacific Ram Publishing, P.O. Box 31578, San Francisco, CA 94131
27. **Taoist Ways to Transform Stress Into Vitality - Inner Soul, Six Healing Sounds**, Mantak Chia, Healing Tao Books.
28. **Foundations of Tibetan Mysticism**, Lama Anagarika Govinda, Samuel Weiser, York Beach, Maine, 1969 edition
29. **Psycho-cosmic Symbolism of the Buddhist Stupa**, Lama Anagarika Govinda, Dharma Publishing, Emeryville, California, 1976
30. **The Cosmic Pulse of Life**, Trevor James Constable, BSRF, 1990
31. **The Amazing Secrets of the Masters of the Far East**, Victor Simon Perrara, BSRF, Garberville, CA



DEVELOPING THE KOLISKO APPROACH

The Correspondence of Metals and Planets Experimental Studies

From a lecture delivered at the annual Conference of the astrological
Association

by Nick Kollerstrom

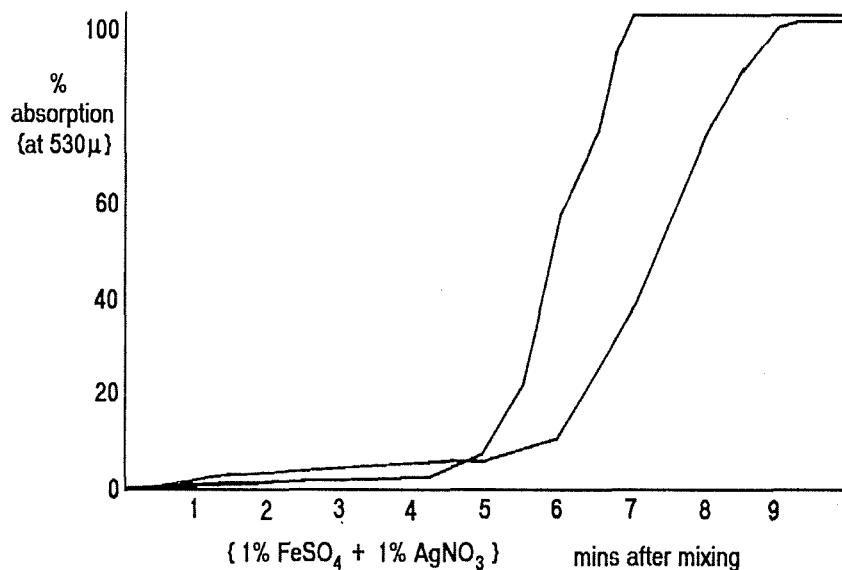

Figure 1. Rate of precipitation of colloidal silver shown photometrically when 1% solutions of ferrous sulphate and silver nitrate are mixed (two identical experiments).

*Nitrate of Silver; formerly called Lunar
Nitrate, Lunar crystals or crystals of Silver,
and when fused lunar Caustic.*

1826 chemical dictionary

We shall be looking at experiments which demonstrate the influence of planetary events upon the behaviour of metal ions in solution: a modern investigation of a belief which stretches back into distant antiquity, that of a correspondence between planets and metals.

Modern theories of matter explain the behaviour of metals in terms of their atomic structure. These theories have developed since the seventeenth century, and before that an entirely different attitude prevailed: the characters of the known metals were interpreted primarily in terms of the planets associated with them. Gold and silver have always been associated with the Sun and Moon since prehistoric times. Then in late antiquity we find copper, iron and lead consistently associated with Venus, Mars and Saturn respectively. Lastly, in the Middle Ages, the metals mercury and tin become definitively associated with the planets Mercury and Jupiter. Without going into any details as to how these correspondences were interpreted or used, we may simply state that they persisted up until the seventeenth century, at which time the development of the new science of chemistry replaced these old cosmic pictures with a totally different approach, which appeared quite incompatible with any notion of correspondences.

Steiner-Kolisko Collaboration

In the twentieth century, the possibility of a new approach to these correspondences has been opened up. In the 1920s Rudolf Steiner, the Austrian occultist, suggested to Frau L. Kolisko that planetary influences should be detectable by using metal salts in solution. He said, "So long as substances are in a solid state they are subject to the forces of the earth, but as soon as they enter the liquid state, the planetary forces come into play." In addition he suggested that she might look at the spreading out of metal salt solutions upon filterpaper.

Kolisko set about developing ways of observing simple metallic reactions. She observed these during specific cosmic events, principally conjunctions and oppositions.

The principle of Kolisko's experiments is as follows. At the time of some celestial event, say a conjunction of two planets, the chemical behaviour of the metals associated with the two planets involved undergoes a change. Their chemical activity changes. By means of experiments using these metals in a sufficiently sensitive condition, this change may be recorded. A sequence of identical experiments, performed at suitable intervals before, during and after the event, will therefore mirror the changes undergone by the planetary influences. The sequence of experiments then

functions as a kind of microscopic theatre, enabling the progress of a celestial event to be followed. It is in a way an experiment with time, with the manner in which a phenomenon varies with time, under conditions in which all possible physical, i.e. earthly, conditions are maintained constant.

Kolisko Methodology

Kolisko developed a chromatographic method of registering these changes. In various ways she allowed solutions of various metal salts singly and in combination to spread across a filterpaper surface.

She discovered that remarkable pictures were formed on the filterpaper using a mixture of iron and silver salt solutions. Very simply, 1% solutions of ferrous sulphate and

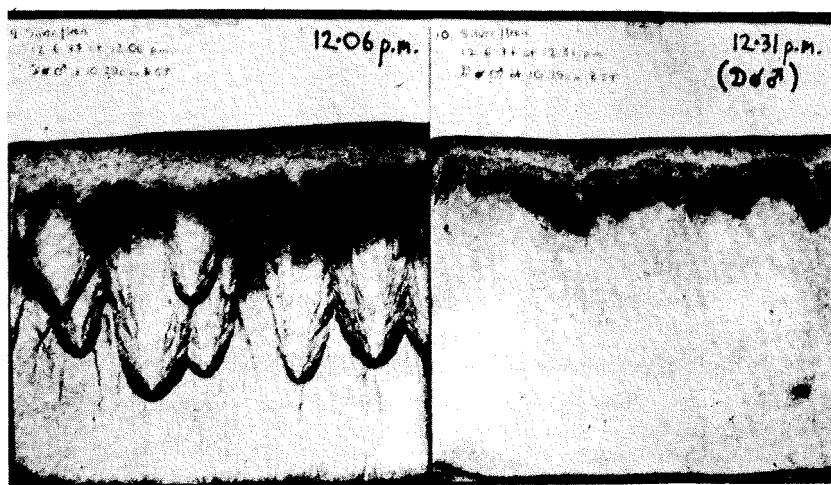

Figure 2.

Two iron-silver filterpaper pictures from an experiment by the author (12.6.77), one 1/2 hr before a Moon-Mars conjunction at 10.29am BST, and the other over the event, showing form disappearance.

silver nitrate are mixed in equal quantities in a suitable dish, and then a rectangle of filterpaper which has been rolled into a cylinder is immediately inserted into the dish. Gradually, as the solution is rising up the filterpaper, the iron slowly reduces the silver nitrate to colloidal silver, and characteristic forms appear. Around seeds of precipitated silver we see how a progressive growth fans out in arrow-like forms. Just as silver is the basis of photography, being so highly light-sensitive, so here it can be used as a sensitive indication of other influences. This iron-silver image is used for registering Moon-Mars events.

Lead can also be added to the mixture for use with Saturn events. This gives us a far heavier, slower-forming image: a 1% solution of lead nitrate is added to the mixture of iron and silver salt solutions, so that white lead sulphate is precipitated, altering the texture of the image.

MOON-MARS CONJUNCTION

11:36 pm on 10.3.70

1.0 ml. of 1% solns. of ferrous sulphate
and silver nitrate

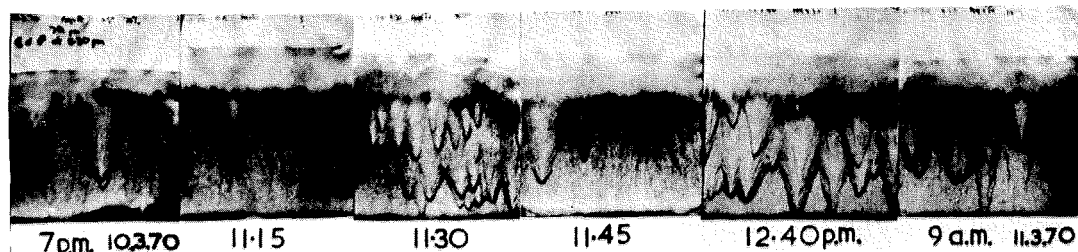

MOON-SATURN CONJUNCTION

1:30 am. on 3.6.70

1.5 ml. of 1% solns. of ferrous sulphate,
lead nitrate and silver nitrate

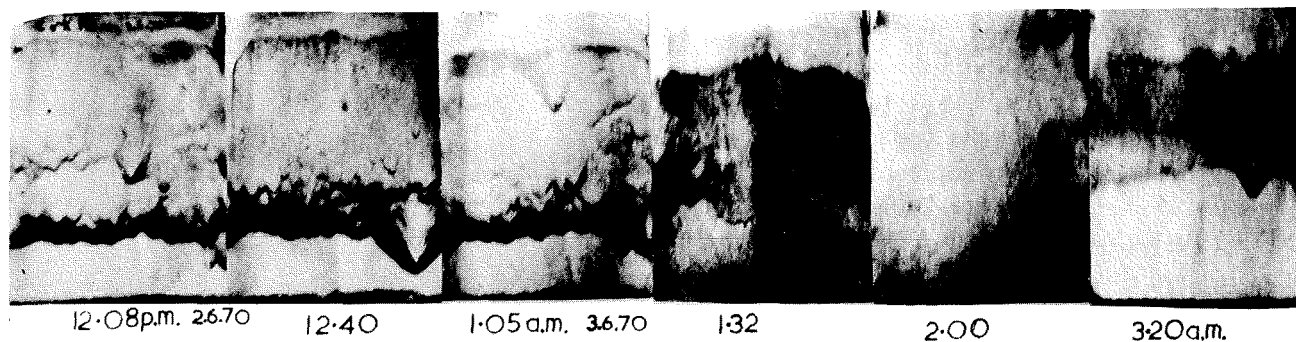

Figure 3(a) A sequence of selected filterpapers showing changing precipitation pattern over a 14-hour period, covering a Moon-Mars conjunction on 10th March 1970.

Figure 3(b) A 3-hour sequence over a Moon-Saturn conjunction on 3rd June 1970, using a lead salt.

Kolisko described an experiment performed over the Sun-Saturn conjunction of 1926, in her book, *Workings of the Stars in Earthly Substance*.¹ This is one of the earliest descriptions we have of a chemical record of a celestial event. Equal amounts of 1% solutions of lead nitrate, ferrous sulphate and silver nitrate were used. At 6 p.m. on the day of the conjunction Kolisko found that all the forms had disappeared from the paper, and still at 2 a.m. the next day, but at 11 a.m. the next day the forms had begun to reappear.

Kolisko performed a large number of such experiments over many years. Tin-silver filterpaper pictures were used to follow Jupiter events, tin being regarded as the metal associated with the planet Jupiter. Successive conjunctions and oppositions of the Moon with Jupiter were followed over a number of years. For each event three filterpaper pictures were made: the first was made on the day before the event, the second at the time of the event and the third on the day after the event. Each time the pictures appeared to show an inhibition of their usual form on the day of the event.

For this combination it is necessary that the metals be allowed to rise separately up the filterpaper: first a 1%

solution of stannous chloride, and then, when dry, a 1% solution of silver nitrate.

Kolisko used various other metal combinations, in particular with gold chloride, which need not here concern us. Kolisko proceeded very intuitively, simply letting nature's forces express themselves on her filterpapers. Her results have therefore been criticised on the ground that she did not maintain physical conditions such as light, temperature and humidity constant throughout her experiments. This may be so. Nonetheless we should appreciate that she developed a profoundly simple way of letting the metals express themselves.

Mars-Saturn Effects

A repeat of the 'Kolisko Experiment' was performed by Theodore Schwenck over the 1949 Mars-Saturn conjunction. He used the iron-silver-lead filterpaper technique as described by Kolisko, in the research laboratory of the Swiss Weleda company. His results were published in the book *The Secrets of Metals* by Wilhelm Pelikan.² Filterpaper pictures were shown formed on the 25th of November, then on the 29th, then on the 30th at 4 p.m., then at 10 p.m. on the 30th, then on the 1st December, then on the 6th. The

conjunction took place on the 30th.

An almost complete disappearance of form at the time of the event is shown by these pictures. Also of interest is the long duration of this inhibition effect: it took about six days for the forms to reappear. An event such as this one where two planets are involved is, as we shall see, a considerably longer event than a Moon-planet conjunction. This draws our attention to one property of these experiments: not only do they inform us of the time at which a celestial event occurs, but they also give us a measure of its duration.

In 1964 Dr. Karl Voss of Hamburg, editor of an astrology journal, followed a Mars-Saturn conjunction and published his results in the 1964 issue of his *Neue Aspekte Journal*.³ Again it was shown how the characteristic image of the iron-silver-lead filterpaper picture, which appeared clearly both before and after the event, disappeared completely from the filterpaper at the time of the conjunction, leaving a formless, diffuse darkening of the filterpaper.

Agnes Fyfe and the Present Series

In 1967 Agnes Fyfe working in Dornach near Basle published an article "Concerning the variability of the iron-

silver filterpaper picture" in German.⁴ She used smaller quantities than Kolisko, only 1 c.c. each of the 1% solutions for iron-silver mixtures, and 1.5 c.c. for the iron-silver-lead mixtures. Two Moon-Mars conjunction sequences were shown apparently demonstrating a form-inhibition effect.

I have used the method as described in this article of Fyfe for my own experiments. Each time, three lots of solution are mixed, and three filterpapers are started. The three different pictures thus obtained give us a measure of the degree of random fluctuation inherent in the procedure. Selected pictures from two Moon-Mars conjunction events are shown, in Figure 3a. The main effect is remarkably brief: it is a short, sharp process. It is possible to depict the change in the reaction rate graphically by measuring the time for the first form to appear on the filterpaper, which is generally between two to five minutes.

Note that these events are all asymmetric with respect to time: the main effect occurs after the conjunction or opposition, as traditionally supposed.

A few selected filterpapers are shown from an experiment performed over a Moon-Saturn conjunction on

**MOON-SATURN
OPPOSITION**
5.30 p.m. on
16th June 1970

1.5 ml. of 1%
solns. of ferrous
sulphate, lead
nitrate and silver
nitrate.

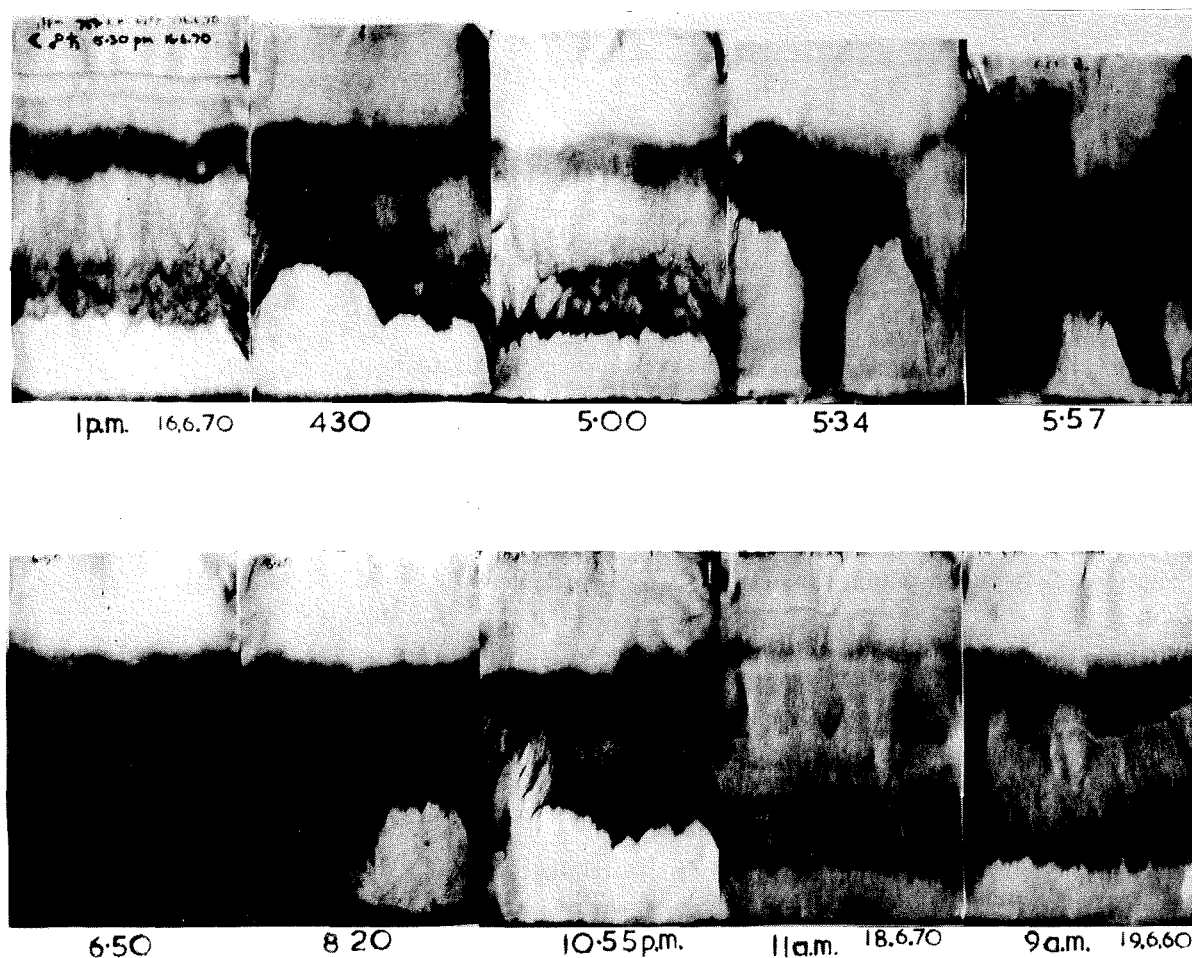
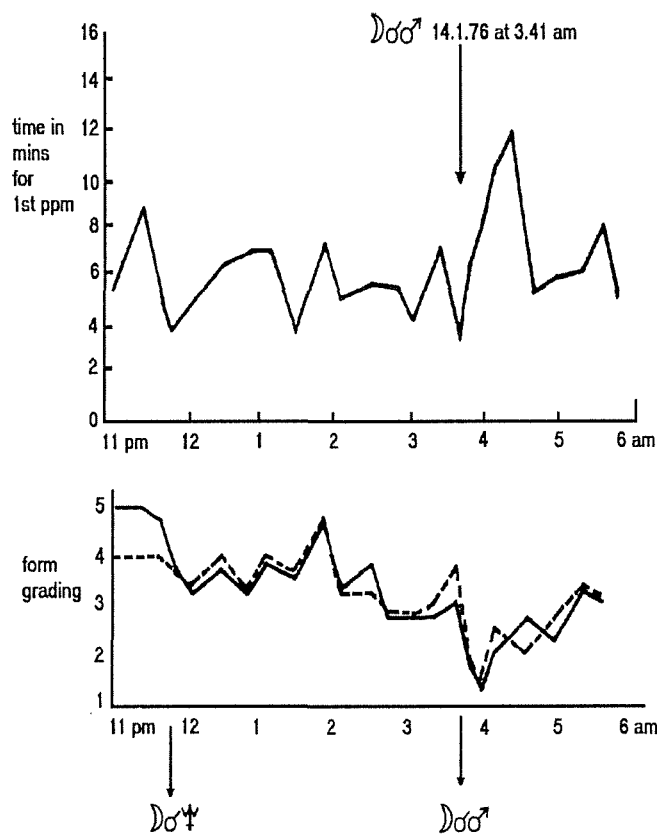

Figure 4. A 10-hour sequence over a Moon-Saturn opposition on 16th June 1970, plus two filterpapers raised on 18th and 19th.

Figure 5. Two graphs of a Moon-Mars conjunction experiment by the author and F.W. Hyde, FRAS, North London.



The top graph shows the rate of reaction, given by the time in minutes after mixing iron and silver salt solutions when the first trace of silver becomes visible on the filterpaper. Each point is the mean of 3 readings. The bottom graph shows a 'form grading' of the same experiment by two independent persons. Each filterpaper was later graded (1-5), blind, depending on how much form was present on it, and each point on the graph represents the mean of the assessments of the 3 filterpapers used. The two celestial events covered are Moon conjunct Neptune and Moon conjunct Mars.

the 3rd of June, 1970 (Fig. 3b). We see how half an hour after the celestial event, all form has disappeared from the filterpaper. It is plainly much slower than a Moon-Mars event.

Two weeks later, the following Moon-Saturn opposition was recorded (Fig. 4). As before, all forms disappeared from the filterpaper shortly after the event. Note how it took several days for the filterpaper forms to return to normal.

Comparative Reaction Times

Figure 5 shows graphically the course of an experiment, over a Moon-Mars conjunction, where each point is a mean from three filterpapers risen each time. Over most of the experiment it took about five minutes before the forms started to appear, but the reaction was slowed down for about half an hour after the event. The increase in reaction

time was associated with a decrease in the amount of form present on the filterpapers, shown in the second graph. The form grading procedure is explained in the next chapter.

Figure 6 shows another experiment done over a Moon-Mars conjunction, this one with an unusually slow reaction rate for the iron-silver precipitation reaction.

For Saturn events, where lead is used as well as iron and silver, the reaction is much slower. Likewise a Saturn-event is a far slower process than a Mars-event.

The occultation of Saturn by the Moon (Fig. 7) lasted about an hour. As before, each point shown on the graph is a mean of three readings. During the occultation, all form disappeared from the filterpaper. After 80 minutes or so, slight precipitation appeared at the top of the paper. I would like here to quote Kolisko's description of the Sun-Saturn conjunction referred to. "To our great astonishment, a long time elapsed and nothing appeared on the paper. In normal circumstances the first forms appear in 10-15 minutes. In this case a whole hour elapsed before the first forms made their appearance."

We see in this graph a comparable arresting of the silver precipitation while Saturn passed behind the Moon. The precipitation of silver was determined by the exact position of a planet one thousand million miles away...

These experiments can be studied from three different points of view: firstly, as forms and changes in form – a purely visual approach; secondly, as a time-process, as in the graphs; and thirdly, as a chemical reaction – what proportion of the silver nitrate was reduced to silver at different stages of this event?

By merely observing these filterpaper pictures we cannot infer what is in chemical terms taking place. Did the activity of the lead ions increase or decrease as Saturn passed behind the Moon? There is a simple technique described by Kolisko which may possibly give an approach

towards being able to answer this. It consists of growing crystals of metal salts by dropping them into a solution of silica gel. Sequences of stannous chloride crystals dropped into a silica gel solution before, during and after a Moon-Jupiter conjunction, and then later over a Moon-Jupiter opposition were shown. These results of Kolisko would seem to show that a minimum in the growth of the tin-salt crystals was connected with the occurrence of a Moon-Jupiter event; in other words, that the activity of the tin salt was decreased during the event: less of the metal silicate "tree" was formed. But this is not nearly so sensitive a method as the filterpaper-picture technique.

Seasonal Effect

In one of her later works⁵, Madame Kolisko gave advice about optimal times of year for performing the

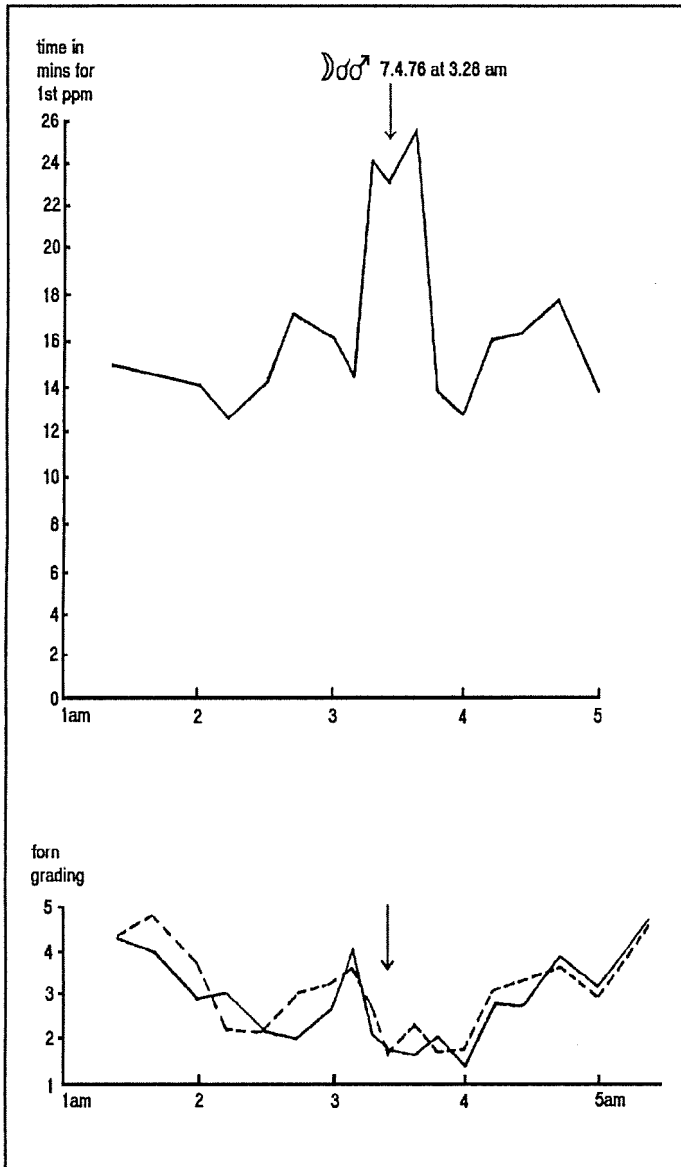

Figure 6.

Two graphs of a Moon-Mars conjunction experiment by R.M. in Barnett, North London. The graphs show rate of reaction and inhibition of form present on the filterpaper, as for Fig. 5.

Figure 7.

Graph showing rate of reaction in a Moon-Saturn occultation experiment, by the author, at Emerson College, Forest Row, Sussex.

Each point on the graph shows a mean of three readings, of the time in minutes after mixing the iron, silver and lead salt solutions, when the first trace of silver became visible on the filterpaper.

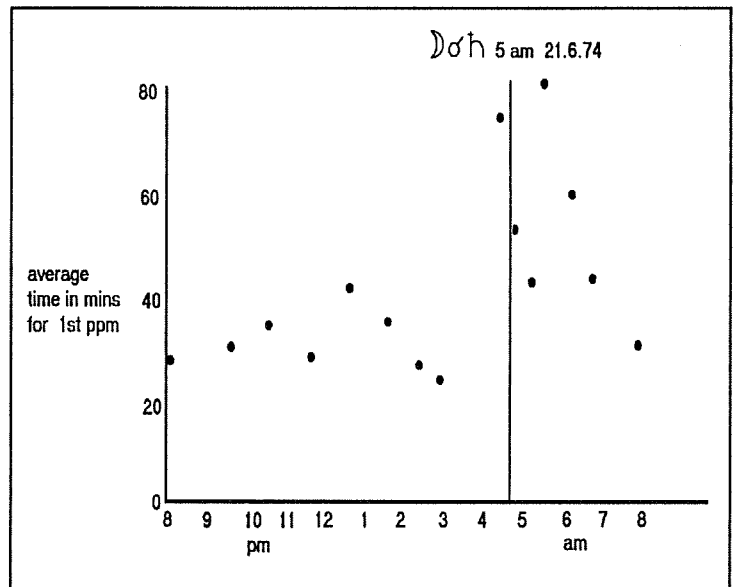

filterpaper experiments with metal solutions. A modern chemist would hardly expect reactions to alter with the seasons of the year, yet Kolisko claimed that 'formative forces' as they expressed themselves on her filterpapers did so vary. Patiently performing the experiments day by day, she followed the course of the seasons. For experiments with silver nitrate, she found:

...from March onwards the formative forces seem to increase, become richer and richer, reach a certain climax, then decrease and disappear completely between December and January. They appear again in the month of March...

I haven't investigated this, but there are indeed times when forms refuse to appear on the filterpapers. For copper salt solutions, Kolisko found that best results were obtained in the early part of the year, around March to May, and 'gold salts are very beautiful in Spring, but also later in the year.' Iron salts worked optimally in September and October, and tin in midsummer, while lead worked best in midwinter.

References

- 1) Kolisko, Stuttgart, 1928.
- 2) Pelikan, Anthroposophic Press NY, 1973 p.24.
- 3) Voss 1964/5, 15:p.1-11, summ. in Firebrace 1965, 4, 4-8.
- 4) Fyfe, Elemente der Naturwissenschaft, Stuttgart, Easter 1967, Vol. 6, 35-43.
- 5) Kolisko, 1948, pp.8, 22.

This article is excerpted from Nick Kollerstrom's new book **PLANETS AND METALS - New Studies in Celestial Influence** due for publication by Borderlands in the spring of 93.

FIND ACU-POINTS WITH YOUR COMPUTER

by Stephen Gibson

Finding acupuncture points the traditional way can be tricky. While a good supply of charts or pictures may bring success after months or even years of practice, there is a short cut method to quickly find the exact spot in seconds.

Acu-points exhibit less resistance to the flow of an electric current than anywhere else on the skin. So a simple ohmmeter can be used to search them out. An ohmmeter may be built from literally, a handful of parts from Radio Shack. But a regular VOM (volt-ohm-meter) works almost as well. Commercial acu-point meters have many useful enhancements. For convenience, they may have an audible output that changes with resistance as the search probe is moved over the skin. The additional circuitry may be just a couple of transistors wired as an oscillator. The ever popular 555 timer IC chip is often used.

A computer interface is not difficult to build. The audio output of nearly any acu-point selection instrument can be tapped by a zero crossing detector circuit. Then a program measures the time between zero crossings as a means to sense the change in frequency caused by the change in skin resistance. The input pins of a serial or parallel port work very well.

But there is even an easier way. Many computers have joystick inputs, commonly called game ports. The IBM computer is no exception. The game port is actually four 555 timer IC's housed in a single chip called a 558. I have found others. But the 558 is most common. The actual joystick is nothing more than a few potentiometers mechanically linked to a handle as part of an RC timing network for the 558. Each timer in the chip is wired as a one-shot and, when triggered by software, produces a change in pulse width as the handle is

moved. The program scales the pulse width to an arbitrary range of 0 - 255. Since the handle merely causes a change in resistance, it occurred to me that I could easily build an acu-point detector using only software and my game port. In fact, other than two electrodes wired to an input connector, just a SINGLE calibration resistor is all that's needed! IBM game port boards sell for as little as ten dollars. So this project is not only easy, it's cheap to duplicate.

To test the idea, I wired a 100K variable resistor to the game port pins 1 and 3 to simulate a wide range of skin resistance. Then, I wrote a simple test program and found, as expected, I could get readings from 100K down to near zero with ease. I added a speaker output to the program using the resistance values as output. They needed to be scaled up to something the two inch speaker in the IBM could reproduce. So I merely multiplied them by five. It sounded fine, so I wired a permanent 15 pin game port connector and mounted the 100K potentiometer in a box. I made sure the 100K pot was wired to pin 1 on the connector since this is actually a direct line to the computer 5 volt power supply. The other wire going to pin 3 leads into the machine's heart of darkness to the 'C' part of the 555 RC network and eventually, the chip itself.

The electrodes were easy to build. I used a small tomato paste can sans label (and contents) as one probe to be held in the hand, and a replacement multitester probe as the skin surface search electrode. It's a good idea to use a probe of the type that allows replacement tips so you can insert the cotton part of a QTIP into the end. The QTIP is moistened with salted tap water to improve skin contact.

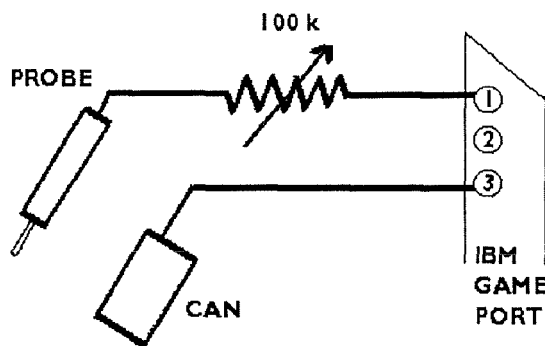

PHYSICAL CONNECTIONS FOR ACU-POINT TESTER

```

10 '
20 'IBM ACU-POINT TESTER
30 '
40 CLS: KEY OFF
50 SENSOR = STICK(O)
60 PRINT SENSOR
70 FREQ = SENSOR * 5
80 IF FREQ < 37 THEN FREQ = 37
90 SOUND FREQ,I
100 TIME.OUT = TIMER
110 IF TIMER > TIME.OUT + .25 THEN GOTO 50 ELSE GOTO 110 'WAIT
        'CLEAR THE SCREEN
        'READ PINS 1-3 OF THE GAME PORT
        'SHOW READING
        'SCALE TO AN AUDIBLE FREQUENCY
        'LIMIT LOW END
        'SEND FREQ TO IBM SPEAKER
        'START A 250 MILLISECOND TIMER
    
```

COMPUTER PROGRAM FOR ACU-POINT TESTER

In operation, the 100K pot is adjusted for a maximum reading of about 127 on the screen while the subject holds the can electrode in one hand and while you hold the search probe in contact with the skin, preferably avoiding an actual acu-point. Move the probe around to be sure. A search can begin once this simple ballpark calibration is out of the way. Move the probe over a known acu-point. The reading on the screen should drop as should the speaker sound frequency. The reading of 127 corresponds to 7 bits turned on by the program. The game port circuitry gets a little flakey when adjusted for the maximum possible range of 255. Stay below 127 for acceptable results.

In actual use, the computer sample can be adjusted to several times per second even on a plain-jane IBM PC. Expect the sample time to drop off with added program overhead as you add graphics and moving averages. But I found a delay routine to be more convenient, even in the test program. Here, I've made the test program VERY simple so you can easily follow the logic and have fun experimenting with your own modes.

There are a couple of caveats. First, is safety. Grounding the computer is mandatory. A power isolation transformer should also be used because the interface is NOT fully isolated from the AC line. Treat this experiment with care, and by all means exercise caution.

The other problem relates to the DC current used so the program can get a meaningful reading. All ohmeter methods need a small current for the search. But it has been found that the very act of searching with an ohmeter accidentally feeds current INTO the acu-points and thereby provides a treatment of sorts. While it may be said that any treatment is acceptable, serious practitioners agree it sometimes louses up an accurate diagnosis. This discovery has led many researchers to reduce the search current to just a few microamps. Others have experimented with search current polarity and the near certainty that AC currents may be better than DC for treatment purposes.

While the IBM game port interface uses a DC search current of around 30 microamps, you may want to try to use less. As a direction to take, I suggest you reduce the current by increasing the resistor value at least ten times, and then make up for the loss with a simple DC amplifier. Keep the output within a range of 0 to 5 volts. A couple of changes will be necessary to the IBM game port. Feed the DC amplifier into the trigger pin (4) of the 558 so it may operate as a voltage to frequency converter. Also, add a variable resistor across game port pins 1 and 3 and, as before, adjust for about 127 on the screen while running the program.

This project is an easy way to explore acu-points. While not without its limits, it does offer a simple way to find out more by using the absolute minimum of parts and effort. I hope it may lead you to further exploration.

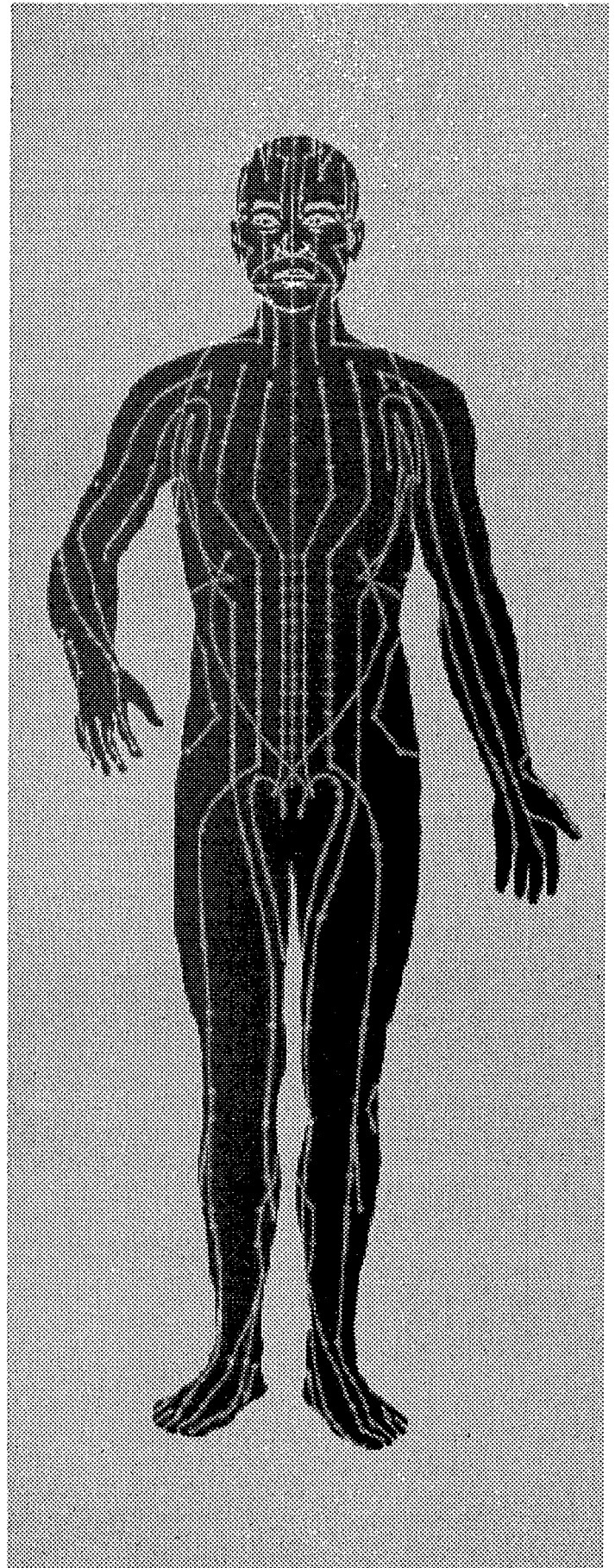

I AM ENERGY

by
Larry
Spring

I AM ENERGY, I am weightless. I have no mass. I come in two states, potential and kinetic. When I am resting, I am potential, but you can not get any work out of me until I am moving, and that motion is relative. Also time plays a part. The more time I have, the more work I can do.

When I am moving I am kinetic, and have the ability to be transferred to mass, causing it to move. The fastest form in which I travel is as a free flying, radiated magnetic sphere. I drive electrons sideways in every conductor I cross. This takes some of my energy.

I AM ENERGY. I ride from the Sun through outer space as cast off spherical magnetic units. I travel my fastest through a vacuum where I have the least interference. That speed is 186,000 miles per second. I am compressed while passing through a medium denser than a vacuum. This appears to make me go slower, but I regain my

size

when

medium. I

around like a ball

electrical conductor

magnetic lines of force
ing me to move electrons
sideways in the conductor.
Which way I drive the electrons
depends on which way my magnetic
lines of force are oriented.

I come in all sizes. 1/100,000 inch for white light, and 1,000 feet in diameter for AM Radio. I have a size for each frequency.

It is easy for me to go into a denser medium like water or glass at a shallow angle to the surface due to compression, and impossible for me to get back out at the same shallow angle from inside a denser medium to a less dense medium due to expansion as I try to enter the less dense medium. This leads to total internal reflection used in fiber optics.

I AM ENERGY. I ride through a conducting wire as an electrical field. I use the repulsion of electron to electron as my medium of exchange. My speed is close to the speed of light. I am handed from one electron to the next. The electrons themselves do not travel very fast. I travel my best when there is no insulation to slow me down, and no heat to drive electrons into vibration, which interferes with my progress. As an electrical current I can do all sorts of things. I can heat filaments white hot for visible light, run electrical motors, operate radios and weld metal. The list of my accomplishments goes on and on.

I AM ENERGY. I am weightless. I am sound. I use molecules, which have weight as my medium of exchange. I travel through air, water, iron and other mass by bumping one molecule against the next. As sound I can not travel without molecules. As sound I can not travel through a vacuum, or in outer space, as there are no molecules. I travel much slower as sound than as light because molecules have weight. It is harder for me to get them moving. Molecules are much heavier than electrons, and especially heavier than weightless magnetic fields. 1,100 feet a second is about my best speed through air. I travel faster through water or iron. I travel from one vibrating diaphragm to the next. You can hear me when I arrive, because your ears have a diaphragm called the ear drum.

I AM ENERGY. I am weightless. I am momentum. I travel on a pool table by the law of mass in motion. The balls are groups of molecules that transfer energy by bumping. They act like big heavy molecules. It takes a lot of energy to move them. The direction I move is determined by the point of contact of the balls.

Everything in the UNIVERSE is moving. Movement is RELATIVE. MASS in motion has MOMENTUM.

MOMENTUM is ENERGY, which equals mass times velocity. Radiated magnetic fields, at the speed of light, are all velocity, and no mass. When I have transferred all of my energy to driving electrons in a transverse direction, I am gone. There is nothing left of the spherical magnetic field I once was. I must have been pure energy.

When I am riding the electrical current, I can be converted back to a magnetic field. The electrons may become motionless, when I am not using them, but they are still there.

As energy I am never lost. I can change my mode of travel, but I always show up again somewhere. That is called the LAW OF CONSERVATION OF ENERGY.

When I am travelling as a magnetic field, I can be guided in a metal tube very little loss, as the large enough to my one

with
tube is
accommodate
half wave length
diameter size. I can go
right out through the walls
of a plastic tube. I can pass
lengthways through a plastic or
glass rod, and I am confined inside
the rod by total internal reflection. That is
the way fiber optic phone lines work.

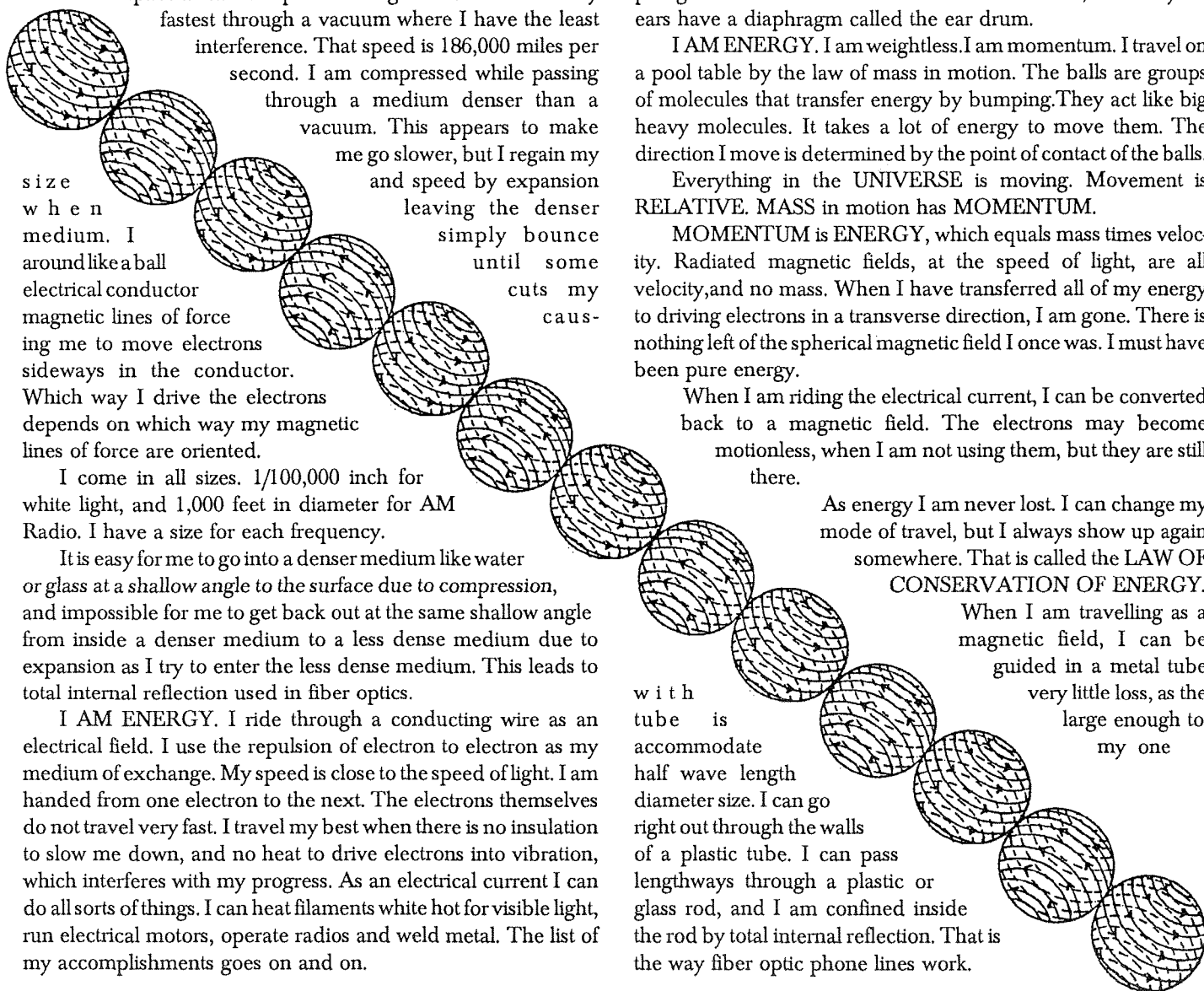

As an electric current I can be guided by a metallic wire for long distances. This method of moving electrical energy is used by power and telephone companies. The electrons can not leave the wire, so, as electrical energy, I must follow in and around the wire.

When I am sound energy confined in a tube full of molecules like air, I can travel a long distance without getting weaker, as I can not spread. When I come out of the far end of the tube I spread, and get thinner by the square of the distance.

As sound, as well as a magnetic field, I can be focused by a reflecting parabolic dish like your spot light focuses photons of visible light.

I AM ENERGY. I make waves on the surface of water. I lift or expand the water as I pass, and the water falls into a trough behind me. The trough is a reaction to an action activated by gravity. Wind passing over water can generate waves. Energy is transferred from wind to water by surface friction. Earthquake land movement can produce water waves. As energy I travel by bumping one water molecule against the next. I travel like sound, and can travel about half as fast as sound when I am in a tidal wave.

I AM ENERGY. I am weightless. I can be stored as a magnetic field around a magnet, or a direct electrical current carrying conductor. There has to be movement through the magnetic field, with a conductor that cuts the magnetic lines of force, to take the energy out. Either the magnetic field, or the conductor has to be moving. It's the relative movement that counts.

AS HEAT ENERGY I can be stored in a THERMOS BOTTLE, because the polished mirror walls are too smooth to cut into the magnetic lines of force of my 1/100,000 inch diameter spherical photons of visible light, or any thing larger, like infrared, known as heat. I just bouncing from to

keep around polished wall polished wall looking for an escape route. As potential energy I can be stored in a battery, in a capacitor, in a compressed spring, a cylinder of compressed gas, mass in motion, rotary motion or electron movement inside the atom, known as heat.

The largest storage space for radiated spheres of magnetic energy is outer space itself. There is so much space out there that radiated magnetic energy can travel in a straight line for a million years without coming across any mass to transfer its energy to.

I doubt that all the SUNS in the HEAVENS, when they are finally burned out, will raise the temperature of SPACE more than a degree or two. Energy can be taken from SPACE, and

converted to an electrical current, simply by cutting the lines of force of those free flying magnetic spheres with a resonant length conductor antenna. Solar cells and crystal radios use this principle. There is so much space out there that ENERGY is spread very thin, except in the path of a concentrated source like energy from the SUN.

I am ENERGY. I can fill a bit of mass to white hot without adding any weight. I drive the electrons in the atom into more determined movement causing atom expansion. I am one portion of the electromagnetic spectrum called infra-red, and better known as heat.

An atom like lead, that is full of heavy protons, heavy neutrons and light electrons, has very little space for electron activity. Lead holds only 3% as much heat as the same volume of water at the same temperature. While outer space is the best space for the least energy

large energy, space for energy (heat) is in the neutron, or a group of neutrons, known as a Neutron Star. Each proton has grabbed an electron. A Sun that collapses totally to Neutrons would neutralize all electron repulsion, leave no space for electron movement, caused normally by passing radiated magnetic fields, and yet contain all its gravitational attraction.

This must be the description of a Neutron Star in a Black Hole. It would remain in its original orbit, which is dependent on its mass in motion, and gravity. Visible light energy should still bounce off of it like from a tiny Moon, but it could not give off light of its own.

I am LARRY SPRING. ENERGY and I have been visiting each other for the past many years. Come and let ENERGY show you what it's shown me. ENERGY is its own best EXPLAINER.

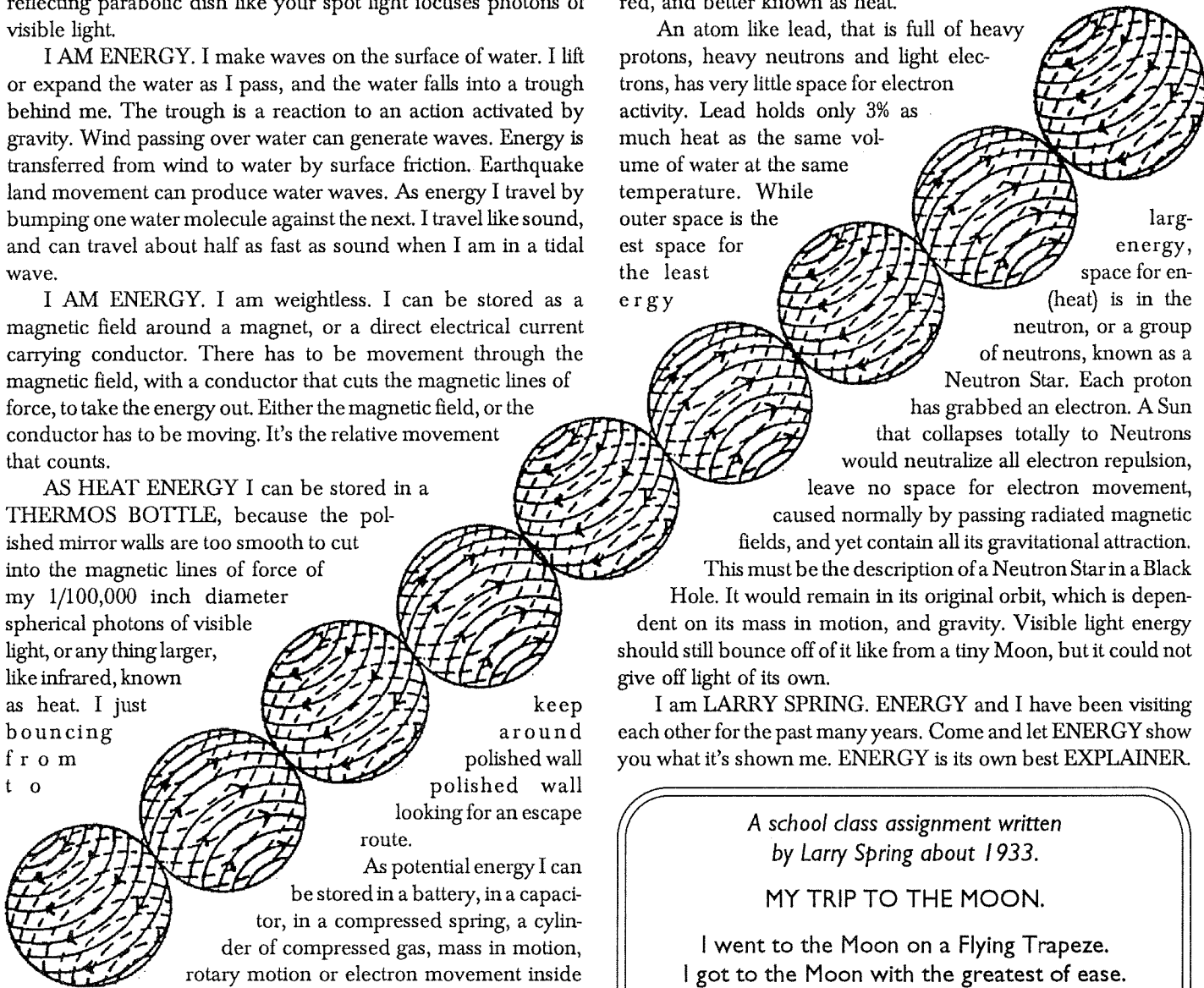

*A school class assignment written
by Larry Spring about 1933.*

MY TRIP TO THE MOON.

I went to the Moon on a Flying Trapeze.
I got to the Moon with the greatest of ease.

I just closed my eyes, and sailed through the air.
When I opened my eyes, I found I was there.

Now, Dear Teacher, I hope you're not sore,
If I had opened my eyes, I might have seen more.

You are on a trip around the Sun.
OPEN YOUR EYES.

A Possible Alternative To Battery Powered Vehicles

© 1993 by Ed O'Brian

Fig. 1

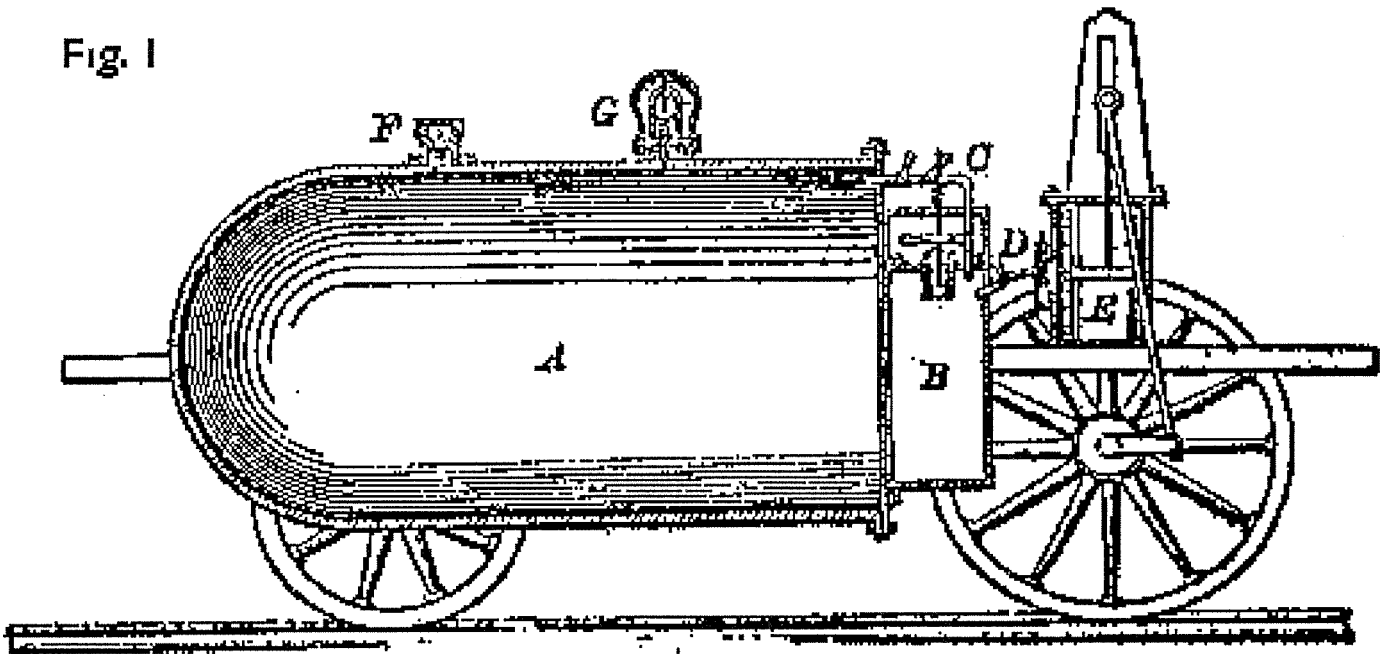

One problem with our current civilization is that it seems to want to charge ahead with all sorts of changes designed to accomplish specific objectives without bothering to take the time for a rational review of what has been done before and then proceeding after considering past knowledge. The contemporary fashionable investigations relative to substituting batteries and electric motors for the combination of gas tanks and internal combustion engines in automotive vehicles illustrate this point.

Such activities are predicated on the premise that in the long run society as a whole will be better off by making this substitution rather than continue with the current use of internal combustion engines or adopt steam powered cars and trucks because: (1) it is more desirable to store power on board a vehicle in batteries than it is to store it in the form of a hydrocarbon fuel in a tank; and (2) electric motors do not give off pollutants while internal combustion engines are inherently pollution manufacturing facilities. This sounds good. But is it?

If a vehicle powered through the use of at least one battery and electric motor is to find any degree of acceptance at any cost it has to be able to operate for more than a minuscule distance and has to be able to have its battery or batteries conveniently

replaced or recharged. In general the larger the vehicle and the greater the driving range desired the greater the battery capacity required.

Batteries having such capacity are not cheap to build and are comparatively large. Because of some of the materials used within them frequently there are serious environmental issues in connection with both their manufacture and, after they are worn out, in connection with their disposal. Under certain conditions many of them can be hazardous to use. It is only common sense that the larger the battery capacity of a vehicle the greater the environmental headaches accompanying or resulting from the use of the batteries.

The most significant of such complications would be eliminated by the use of compressed air engines corresponding to those employed in the mid 1800's modified to use current technology. Figure 1 is a drawing of an early engine of this type as developed or invented by a Mr. Parcey in 1847 taken from Knight's American Mechanical Dictionary published in 1876 (volume 1, page 604).

The essential parts of the engine are a compressed air tank and a connected piston and cylinder mechanism used to convert

the power of the stored compressed air into mechanical motion. Although such a tank is essentially a power or energy storage structure and the piston and cylinder mechanism is an engine, for unknown reasons the entire device is referred to as an "engine".

Such a compressed air engine clearly does require all of the possibly hazardous materials in most batteries, particularly "exotic" ones which apparently are destined to replace lead-acid cells as a current standard in the automotive field. The manufacture of such an engine structure with today's technology is clearly no "big deal". Only "normal" engineering materials need be used in its construction.

Although the Parcey engine was apparently designed for railroad use it can be scaled down to the size necessary to run a small automotive vehicle. This is shown by the fact that small toy vehicles using the essential parts of a Parcey type compressed air engine were widely sold in the 1980's in at least the US and Japan. These toys were inexpensively manufactured using injection molded polymer parts. They had excellent performance characteristics

As a consequence of their simplicity it seems likely that an engine similar to the Parcey structure constructed in accordance with current technology would last longer than any vehicle in which it was installed. If for any reason it would become necessary to junk a modernized compressed air engine the disposal of the "routine" materials in it would not present any hazardous waste type problem.

The only two significant, primarily non economic drawbacks to the use of the Parcey type of compressed air engine apparently are: (1) the possibility that the air tank or other parts containing compressed air might rupture and cause damage and (2) the undesirability of transporting an air tank of a size needed to achieve a significant driving range. Of these two items only the second has current significance.

Because of the accumulated knowledge pertaining to air tanks the possibility of such a tank rupturing does not seem to be a significant complication. Pressure relief valves are effective. In view of the current use of moderately compressed air by motorists at gasoline stations without restriction it can be expected that neither the handling of compressed air in "refilling" a vehicular air tank will be a problem.

A significant concern with respect to the use of compressed air engines is tank capacity. It is more of an engineering trade off question than a problem. The distance a specific vehicle will travel when powered by one of these engines is primarily a function of the size of the air tank and the pressure of the gas within it. The maximum pressure which can be used with the tank is limited by the details of its construction and this in turn is related to economic considerations.

Although tank costs increase with tank size the maximum size of a tank to be used with this type of engine is essentially a matter of choice. It must be small enough so that the tank can be conveniently supported on and carried by a vehicle. The tank also must be of a size which is large enough to obtain a driving range sufficient to satisfy most users of these vehicles. From current discussions about the possible driving ranges of vehicles using various batteries and electric motors it appears that experts

of the automotive field do not currently agree as to what this driving range should or should not be. Apparently they all agree that it should be as large as possible.

It is considered self evident that the size of a compressed air tank necessary to achieve any reasonably acceptable driving distance in even a comparatively small car is going to be comparatively large, probably so large that many will consider it impractical to use such a tank on a vehicle. There appears to be only one easily apparent way of getting around this obstacle while retaining the non-polluting benefits of a compressed air engine drive mechanism.

This involves "modifying" the air in the tank so as to get more "power" than can be obtained by filling the tank with normal compressed air. In other words to hold down the tank size "compact" the gas used so as to get more energy without increasing the pressure to the point where the tank is apt to blow up. The gas mixture known as air and the major components of this mixture — nitrogen, oxygen and carbon dioxide — as well as some organic gaseous compounds can all be "compacted".

Air, nitrogen and oxygen and a number of organic compounds which are volatile under normal conditions can all be "compacted" by being liquefied in accordance with known technology while carbon dioxide can be easily converted to a solid — so called "dry ice". Environmental and hazardous considerations beyond the scope of this article effectively preclude the use in a vehicle of any gas or gas mixture except liquid air, liquid nitrogen or liquefied mixtures differing from air merely by a decrease in the relative proportions of the oxygen present.

A modified mechanical assembly based upon the early Parcey engine which can use any of such liquefied compositions is shown in Fig. 2. Since the component parts used in this particular structure are labeled in Fig. 2 and, except in connection with one part, perform rather obvious functions it is only considered necessary to discuss this particular part. It is the auxiliary air tank shown. This tank is intended to provide an emergency supply of compressed gas to move a vehicle a short distance to a location where liquefied gas is available in case the Dewar flask should become substantially empty.

From a mechanical standpoint the structure portrayed in Fig 2 is simple and straight forward. It will only present "normal" type technical problems to an engineer or engineering team assigned the task of making it. There is no reason why such problems should be insurmountable or as to why the costs of such structures should be comparatively high. However, the fact that a vehicular power system may be technically achievable at a reasonable cost does not mean that it will be economically desirable or acceptable to that part of the public expected to purchase and/or use a vehicle equipped with it.

Probably the most significant concerns to purchasers and users will be the cost of the liquefied gas or gas mixture used and both the convenience and safety of filling the tank in a vehicle with such a composition. To achieve consumer acceptance it should be substantially as quick and easy to store and transfer the liquefied gas or mixture used as it is to store and transfer other liquefied gases such as some low molecular weight petroleum fractions. Since the sale and delivery of the latter is routine at

many "gas" stations it is logical to believe that in time the sale and delivery of liquefied gas mixtures based on the contents of air will also become routine, even though the temperatures of the latter are lower than those of liquefied petroleum gases.

A presently unanswerable question relative to the use of liquefied air or gases found in air is how much such compositions will cost. Past costs based upon the production of oxygen and nitrogen and mixtures thereof from air by long known cryogenic

processes are meaningless in answering this question. They often have been based upon the expense of producing relatively pure oxygen and nitrogen for markets which are minuscule as compared to the potential automotive "fuel" market.

Because an engine using a piston and cylinder cannot distinguish between inert gas compositions there is no need for the expense of a relatively pure gas composition for automotive use. It is only necessary that the gas or gas mixture used be relatively non corrosive to materials which will be contacted by the gas or gas mixture. Virtually any liquefied gas or gas mixture derived from air is relatively inert.

Generally speaking the lower the oxygen content of such a gas or mixture the greater the relative inertness of the gas or mixture. This makes developing and current techniques for producing relatively impure oxygen and nitrogen through the use of somewhat selectively permeable membranes or barriers increasingly significant in the choice of a particular liquefied composition for vehicular use.

Because of anticipated changes in technology in a number of different fields in which impure gas mixtures can be and are used it is anticipated that the demand for relatively impure oxygen obtained from ambient air will increase. It is also believed that as this demand increases that the cost of producing such oxygen will decrease while more or less concurrently there will be a continuous increase in knowledge and experience with oxygen permeable membranes or barriers used to provide both oxygen rich and oxygen depleted mixtures.

Although the low oxygen "fraction" as currently produced with such barriers and membranes will normally contain carbon dioxide and oxygen as well as other gases it predominantly consists of nitrogen. It can be referred to

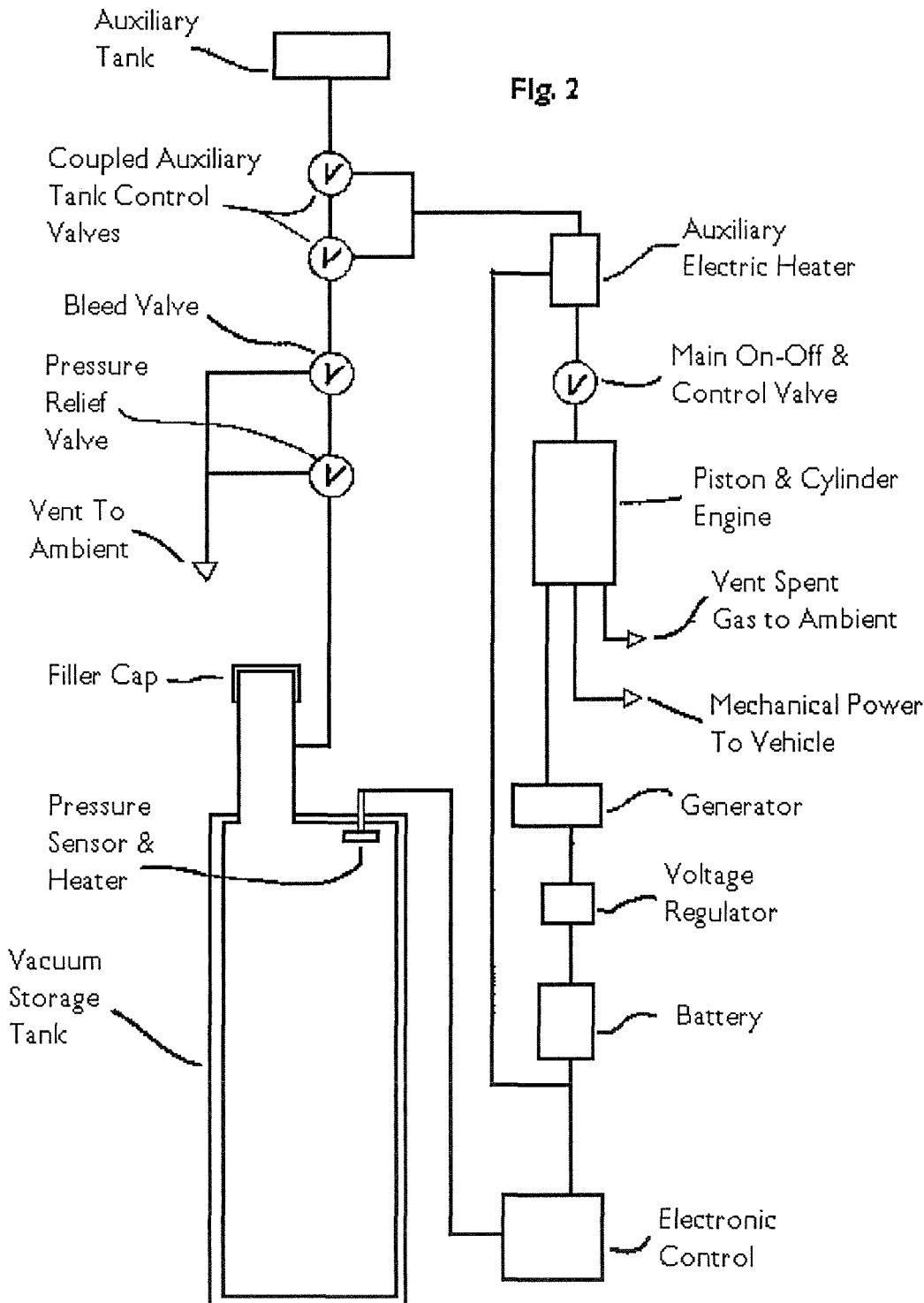

as "nitrogen", albeit very impure nitrogen.

Even though there are currently significant markets for nitrogen it is believed that it is currently a more or less unwanted byproduct from the separation of oxygen from air. As the uses for oxygen grow, particularly as the use of oxygen in water treatment takes over from the present essentially irrational use of chlorine, more and more organizations are going to be saddled with the problem of getting rid of the impure nitrogen resulting from the removal of oxygen from air.

To avoid dumping this impure nitrogen back into the air such organizations can be expected to be very cooperative in assisting in it being used as an energy source for various types of small vehicles. Because of its relatively low oxygen content this impure nitrogen will be less of a hazard than normal air and should be somewhat less corrosive than normal air. In short, unless the costs of liquefying impure nitrogen derived from air do not change significantly it seems to be a very suitable composition for use as a replacement for compressed air in composite compressed air engines.

The costs of piston and cylinder engines and other similar mechanical engines using liquid nitrogen can be expected to be roughly in the same ball park as the costs of electric motors of about the same output. Because of this the decision relative to which of the two types of composite drive systems is better than the other in small cars and trucks in part relates to the advantages of using liquefied impure nitrogen with vacuum flasks or containers instead of using electricity and batteries. A complete detailed analysis of this issue involves factors which cannot be completely analyzed at the present time and which can be expected to change as society and technical knowledge changes as time progresses.

One factor relates to the size and weight of suitable batteries and vacuum containers as will be reasonably needed to achieve acceptable driving ranges. Even though comparatively new, comparatively "exotic" batteries apparently are significantly less heavy per ampere-hour of capacity than tried and proven lead-acid cells the number or volume of even such new batteries required to power a suitable vehicle a reasonable distance apparently will be undesirably large. Substantially the same problem is to be anticipated in connection with a Dewar tank which is large enough to hold adequate liquefied nitrogen to propel the same vehicle the same distance.

While neither liquid air nor battery propulsion seems to have a significant advantage over the other the situation relative to "power" or "fuel" costs is quite different. From the point of view of direct power costs there can hardly be any question but that batteries capable of being charged from conventional power lines are more desirable than comparable amounts of impure liquid nitrogen.

Most batteries which might be used to achieve this to operate a specific vehicle for the maximum amount possible when fully charged can be recharged directly from an electric line using a specific amount of electricity. It seems logical that the liquefaction of sufficient nitrogen to operate the same vehicle to the same extent will require roughly about the same amount of electricity. In addition there will be additional costs in storing and transporting the liquefied nitrogen which will not be incurred when

common line current is used to recharge the batteries employed.

Another economic consideration which probably offsets the cost of liquefying nitrogen relates to the costs and problems of manufacturing and disposing of the batteries required with battery powered propulsion systems. Since a number of different batteries and battery systems are currently under development for possible use with small vehicles there is currently no way of prognosticating precisely what these costs and problems will or will not be.

Because most of the promising new battery systems apparently being considered for propulsion purposes use less commonly available materials than are employed in lead-acid cells it is reasonable to expect that whatever batteries may be the most desirable for vehicular use will be subject to about the same problems as are encountered with lead-acid cells. Environmental and ecological concerns relative to lead in these batteries have become so significant that it is now common to perform important manufacturing steps in making them outside of the US where laws and regulations are less stringent and tort lawyers are less voracious. After these batteries are worn out there are related but different concerns about junking them.

On this point liquefied nitrogen compressed air type engines are more desirable than power schemes using batteries. The tank or container used with liquefied nitrogen in a vehicle can be made using non ecologically and non environmentally sensitive materials and can be expected to last longer than the vehicle upon which it is installed. Such a tank or container definitely will not wear out in the sense that most rechargeable batteries deteriorate after significant use.

Probably an important, critical factor in a decision as to whether to use a battery-electric motor system or a liquefied gas compressed air engine system in vehicles is customer convenience. No one can argue that it will be as easy to fill a tank with liquefied nitrogen as it is to fill up a car or truck with common gasoline. It will probably be slightly more complex than it is to transfer liquefied petroleum gases or natural gas to those few vehicles equipped to use such fuels.

The equivalent of filling up a fuel tank with batteries is quite different. Depending upon design and engineering choices as will have to be made if and when battery powered vehicles are adopted either a significant amount of time will have to be set aside for battery recharging or facilities will have to be set up to replace discharged batteries with freshly charged replacements. The purchasing public is not ready for such procedures and can be expected to greet either of them with pure agony. They will make comparatively long trips undesirably difficult.

With liquid nitrogen power such trips probably can be made with only slightly more "refueling" problems than are encountered at present with gasoline and diesel powered vehicles. As a consequence it is believed that the present publicity oriented activities to produce battery-electric motor powered utilitarian vehicles should be dropped and replaced by efforts to use updated past technology in the form of liquid nitrogen operated compressed gas engines. While systems using such engines do emit an exhaust, such exhaust is only harmless oxygen depleted air.

We can look at *Design Ecology* from a number of different perspectives. Indeed, especially in the beginning, each practitioner will have a uniquely individual way of expressing this science. This is due to the fact that we are in a period of intense cross-fertilization and experimentation. Following are some of the ways in which the various disciplines constituting *Design Ecology* are used in practice...

風水

Feng Shui
Wind & Water

Design Ecology II Practical Applications

©1993 by Michael Riversong

FENG SHUI

This is by far the oldest discipline covered under the scope of *Design Ecology*. Difficulties are often encountered in its practice because of contradictory approaches promulgated by various schools. Even though its practice is currently banned in mainland China, large numbers of overseas Chinese have continued a profusion of Feng Shui schools.

We can broadly classify the contemporary schools of Feng Shui into three categories of practice. These are: Astrological, Compass, and Black Hat. Throughout the various schools, a system of classifications by five elements and eight situational categories (known as Ba-Gua) remains constant. This system is the core of the I Ching, and thorough study of that ancient document is highly recommended for anyone who wishes to gain competency in Feng Shui consulting. The Ba-Gua, more commonly known as Trigrams, are presented at the beginning of almost every edition of the I Ching. Most Feng Shui practice follows the "Sequence of Later Heaven" arrangement.

The five Chinese elements are: Fire, Earth, Metal, Water, and Wood. Students of classical European thought will readily see the sharp difference between Chinese and European thinking along these lines. These elemental forces are also used extensively in medical diagnoses, and, particularly in the Black Hat schools, are directly interrelated with acupuncture practice in several key ways, including physiognomy.

Astrological schools of Feng Shui are little known in the West. This may be partly due to the confusing nature of Western Astrology, which has several schools of thought divided between different ways of reckoning the starting point of calculations. Similar problems exist among Chinese astrologers. Building correlations between Chinese and Western systems is thus nearly

impossible. The symbolic structure employed in Chinese culture also remains daunting to Western students, as does the twelve-year cycle commonly used as a focal point of calculations. Chinese astrology was most intensively employed to find good matches for arranged marriages, which are looked on with disgust in contemporary Europe and America. Therefore, little of Chinese astrology has found any practical application for Westerners.

There is a little-known system of Chinese astrology which ignores the popular 12-year cycles and concentrates on a 9-part matrix cycle of influences. This system is firmly grounded in the I Ching, but has only been used by a minority of practitioners. It's primarily known to macrobiotic people in America, under the name "Nine Ki System".

The Compass schools are best presented in writings by Evelyn Lip and Stephen Skinner. Emphasis is placed on physical directions and their subtle interplay with extant landforms. For example, a large, pointed mountain to the north of a building can create a "fiery" attitude among the building's occupants, causing emotional instability but still allowing for protection from natural disasters. If the same mountain were to the south of the building, the fiery attitude would be even more intense, with the added problem of no protection from disasters.

Every Compass practitioner must become intimately familiar with the Chinese Luo-Pan compass. Several models are available, all of which contain concentric rings of Chinese characters indicating characteristics of each direction. The eight directions are classified along the lines of the Ba-Gua. Since most Chinese maps put South at the top, the "Sequence of Later Heaven" arrangement from the I Ching is the correct way to orient oneself to directional characteristics on a Luo-Pan compass.

Landforms are classified according to elemental characteristics. The associations are: Fire - pointed; Earth - flat; Metal - domed; Water - broken; Wood - columnar. These associations can also be applied to building shapes. Gradations between these shapes are given in some manuals.

Black Hat Feng Shui practitioners use the same basic conceptions as Compass school people. Two main differences have arisen. First, instead of always relying on physical directions to determine building characteristics, the entrance of a building or room is always considered as the North end. Then, the Ba-Gua characteristics are mapped onto the room from that point. This system contains a certain amount of flexibility not found in compass-based conceptions. According to consultant Thomas Howes of Napa, California, the human mind contains an imprinted map of the Ba-Gua characteristics. This is, then, a neurolinguistic phenomenon. If a particular part of a building or room is blocked off, missing, or enhanced, psychological results will consistently occur which cause behaviors in patterns corresponding to the observed physical characteristics.

The other difference is in the use of so-called "transcendental cures", which are a series of rituals for clearing negative energies and enhancing positive energies. These rituals are firmly grounded in Chinese culture. According to custom, they must be transmitted in a prescribed manner, and so cannot be described in a summary article such as this one.

BAU-BIOLOGIE

Every building is considered as an individual entity composed of many material characteristics. Unlike Feng Shui, no broad classification of buildings according to psycho-social effects exists in Bau-Biologie.

First, one must consider the composition of building materials, and their possible impact on health. According to Bau-Biologie, the best building materials are often those which come from indigenous natural sources. In Ireland, then, thatch roofs would be best. In southern Europe, clay tile roofs are good. Forested places provide wood. Most regions provide sufficient materials to create healthy buildings. If a region does not provide such materials, we need to seriously question the presence of humans there in the first place. Artificially enhanced materials often are the culprits when adverse health effects are encountered. Formaldehyde and toluene are examples of chemicals used in modern building materials which have been proven to cause allergic reactions in many people, and so must be avoided. In some cases, no mitigation is possible against chemical pollution in a building.

Heating and ventilation are of great concern in Bau-Biologie. Many modern heating methods suck electrons from the air, and so weaken people in those buildings. Gas forced air and electric radiant heating are two examples of methods with this problem. The best heating systems are those which heat the floor through embedded air or liquid channels. A small amount of heat in the floor will normally provide more

comfort than a large amount of air heat. Ideally, buildings need to be constructed loosely enough to allow some outside air to enter, and tightly enough to hold in sufficient heat in winter. If heating is concentrated in the floor, people will naturally feel warmer and thus less energy will be needed.

Electromagnetic fields are another concern in this discipline. No exact correlations between health effects and electromagnetic field levels are in place at this time, although anecdotal evidence provides strong suggestions of correlations at certain field strength levels. The worst health problems seem to be associated with sleeping in magnetic fields. Most Bau-Biologie practitioners simply try to bring field strengths to the lowest level possible, on the assumption that anything out of accord with natural levels is not healthy. Sometimes, this can be achieved by simply moving certain appliances around in a house. Electromagnetics is a subject worthy of an article all its own.

Generally, everyone should be aware of the service entrance where electricity comes into a house, and keep essential activities away from that area. Magnetic field strengths can also be reduced with special metallized paints available in Europe. Demand switches, which shut off electricity to all circuits not currently needing power, are commonly recommended. (As of this writing, UL approval of these devices in America is pending.)

DOWSING

Societies all over the world are devoted to enhancing the practice of dowsing in all its forms. The biggest problem facing this field is consistent accuracy in readings. Wolfgang Maes, one of Germany's top Bau-Biologie consultants, once hired six dowsers to check an apartment which had been carefully measured by the latest (and most expensive) scientific equipment and found to be clear of any noxious energy patterns. He got back six radically different pictures of intense geobiological energy forms found by the dowsers, along with suggestions for elaborate and expensive "cures" sold by the practitioners themselves.

In spite of this kind of problem, intense experimentation persists both in the United States and Europe. A few dowsers have postulated that bits of wire can be placed in strategic patterns to block negative energies. Most of these practitioners use spirals, G-shapes, and L-shapes of pure copper wire. Since the results are still difficult to verify, all we can do is keep watching with the hope that these experiments will someday yield verified consistent results applicable in many situations. In America, among the most effective experimenters are Vince Wiberg of Los Angeles, and the team of Bill Reid and Slim Spurling in the Denver area. Vince has been working as a consultant for over 20 years, and so has built up a tremendous amount of experience. His work is difficult to duplicate at this point. However, he has had some success in teaching his techniques to other individuals. Reid and Spurling work well together, and are pioneering the idea of cross-checking results

as a team. They feel this creates more accuracy during the diagnostic phase of a site survey.

In the future, research should focus more on this team concept, which offers promising methods of validation. Comparison with gravity-wave and radionic measurements is also appropriate, and should help verify dowsing results with more accuracy. We have yet to see a fully digital radionic device that can be applied to geobiological fields, but one will probably appear soon.

For now, the basic dowsing tools for most practitioners are: hazel forks, an ancient tool rarely used today; bent wires; pendulums made from a variety of materials, including crystals, brass, and glass beads; and cheap radios, which allow dowsers to hear the effects of many subtle field patterns. The less selective a radio, the more useful it is for dowsing, because it can then receive a wider variety of static patterns, any of which could be meaningful.

A DESIGN ECOLOGY BUILDING SURVEY

Each practitioner will develop a unique style of surveying and reporting. Some use computers to generate reports, others use forms, and some just rely on the client to take notes during the survey. Each approach works, by giving clients solid recommendations on how to redecorate or remodel for better results in one's life.

Here, I will briefly describe my own procedures, as an example of how this practice can work. First, while coming up to the door of the house, I examine the surrounding environment. Specifically, I'm looking for nearby buildings that may affect the place being surveyed, landforms such as hills, rivers, and lakes, and traffic patterns in the neighborhood. Then, the entrance is carefully considered, to make sure it's clear of any obstructions, and that it has other favorable aspects.

Once inside the house, I set up my laptop computer, usually in the kitchen, and begin taking notes. This procedure saves time, as the notes are later incorporated into a printed report for the client. Hallways, room layouts, and relative angles of walls and floors are considered. At this time, the basic furniture arrangement is checked out, especially in the living room. The entire time in the house, I always keep my nose ready for any smells. Over several years at construction sites, I've become familiar with the odors of many toxic chemicals, and can identify the most commonly misused ones.

After the basic look around, I get out the meters. First in line is an Integrity Electronics 60Hz Gaussmeter, which is similar to many on the market today. As a backup and cross-check, I also use a custom-built unfiltered gaussmeter from Super Science. All rooms of the house are surveyed with one or both meters. Then, I go back through with a geiger counter, to look for high levels of radiation (which are rarely found). If the client is reporting health problems characteristic of electromagnetic fields, I drag out the Electro-Stress Meter, made by the Institute of Bau-Biologie and Ecology. This is a little

complicated to run, because it involves about 20 feet of ground wire to get the readings right. Therefore, this test is only run in working and sleeping areas.

During the electromagnetic and radiation walk-through, I usually pick up other design factors which may have escaped initial observation. If stagnant air or ventilation seems to be a problem, I'll bring in some incense and do smoke tests to find air flow patterns. I also look carefully for Feng Shui considerations, such as missing corners, awkward room designs, slanted walls or ceilings, and colors. More notes are typed into the computer.

After the electromagnetic portion of the survey, I usually go outside, to look at all the landscaping. Sometimes, this also uncovers the source of any strange electromagnetic problems. At this time, I may work with dowsing for geobiological factors, if that seems appropriate based on the client's belief system and symptoms. Usually, I use a pendulum and a cheap five-band radio to uncover indications of these patterns. Sometimes compass deflections are also noted.

Finally, after summarizing recommendations, usually in a priority order, I leave the site. Over the next two or three days, I may research unusual points brought out by the survey in my library or resource database. After that, the final report is edited down for printing and sent to the client, along with general information sheets and addresses of recommended suppliers. Recommendations on appropriate music to add to a place are also usually included.

CONCLUSION

This gives a general idea of current Design Ecology practice. In the next article, I will discuss in depth the contributions of Buckminster Fuller to this field, and how his mathematical processes can uncover significant terrestrial structures affecting all life.

DESIGN ECOLOGY RESOURCE LIST:

THE ART OF PLACEMENT

43 Grand Boulevard, San Mateo, California 94401

THOMAS HOWES CONSULTING

2344-B Silverado Trail, Napa, California 94558

INSTITUTE FOR BAU-BIOLOGIE

Box 387, Clearwater, Florida 34615

ELAINE JAY FINSTER

P.O. Box 12, Denver, Colorado 80231

SUPER SCIENCE

P.O. Box 392, Dayton, Ohio 45409

Michael Riversong, QI CONSULTING

P.O. Box 36387, Lakewood, Colorado 80236

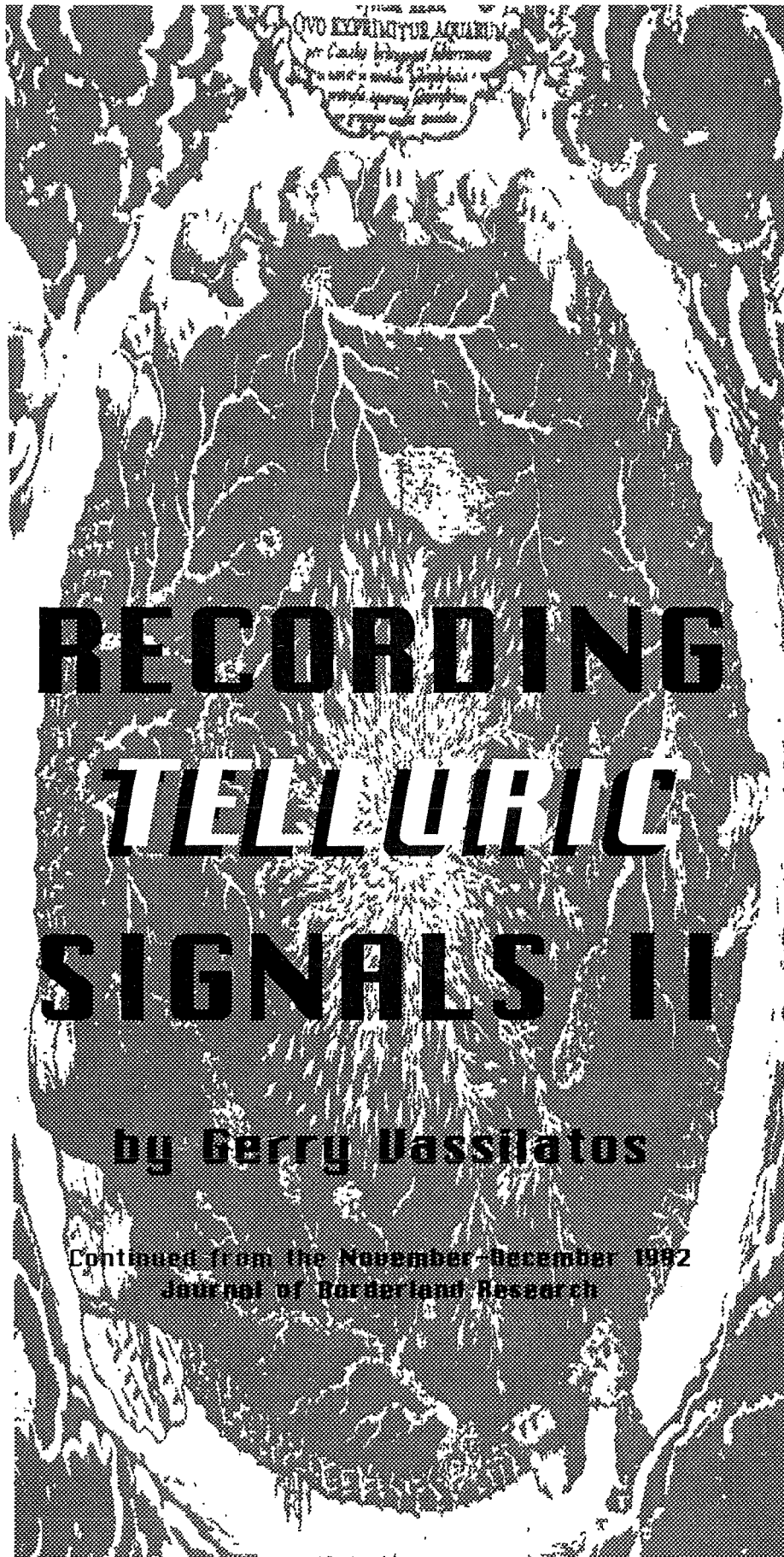

RADIONIC RATES & OVERTONES

Against the background of ground-generated noises each material is identified through its own differentiable series of overtones. Each tone signature conforms with the essence of the material from which it emanates: materials each maintain their fixed identity throughout every sensate range. Material identities are continuous and fixed; maintaining and representing their created essence. [Iron "sounds" metallic, carbon sounds "warm", amethyst is accompanied by a rich "dark-violet" sensation]. The overtones of each material are psychoactive signals: living energies which transact the essence of their parent bodies directly into us. The iron overtones prove to give the sharp odor and sense of the metal...upon listening. Copper did the same...with a "sweet" odor. The studies of B. Payne with planetary light and water are corroborated in the audio realm with similar phenomena.

In every new sample I have discovered different overtone "warblings"; different overtone "dances". These include varieties which (without precedent) suddenly make their audible appearance during each recording. The curious feature of these "sudden overtones" is that (once they appear) they do not cease! This phenomenon suggests that each new such sound registers the advent of some "tonal conductivity" which the materials each engage when in the ground after a time. For this reason I always allow each sample to "soak" in the ground aura for a long while before committing their tones to a recording.

While listening to the playback and the various speed-regulated tracks taken from each material, I became aware that each tone-signature exhibits measurable radionic aspects. In attempting to balance tones (against a raised volume level) I realized that certain overtones were suddenly appearing in the mix as I simply adjusted the volume control. To my utter amazement, I found it possible to entune 2 or 3 distinct "bands" of overtones in the tree recordings WITH THE VOLUME CONTROL ALONE! Within these harmonic bands there exist many fine-degrees of overtone shifts which cannot be accurately reproduced on cassette tape. Those bands which you will hear are the major boundaries between tone-groupings. Only these major boundaries are successfully translated to cassette; occurring at the very limit of the tape-transfer process. In addition, one MUST USE HEADPHONES to hear each overtone distinction!

Through this simple means I was amazingly able to detect real (radionic) overtone groupings when using various volume settings for each material in my collection. Tuning pitch through a volume control is anomalous if you do not understand radionics. These overtone groups are not the ordinary result of audio distortion: I made sure that the signals were not

distorting at the console. The potentiometers (slide controls) were acting just as radionic tuners. [Volume settings represent different path-lengths through resistive materials. Auric signals travel outside or through the resistive material according to their energy level. Nodes are formed where the energies emerge. These are sensed and located as "stick points"].

The emergence of distinct overtone-groups is shattering to all conventional criticisms. If I were to assert the essential living quality which I hear in these overtones few (I doubt) would accept the statement. This demonstrable fact however indicates that tone-signatures are more than just complex collections of tones and pitch: they are possessed of a true and living nature. If the overtone groups were the result of ordinary distortion, then each sample would offer the same variations upon adjusting the potentiometers. But these are found on different locations of the volume setting and each have distinct details which mutually differ. This discovery was an accidental observation.

The discovery that tone-signatures do not all share the same radionic sounds or the same number of overtone bands was unexpected. Two such variations existed for the magnetic pickup recordings but were not as strongly defined as those taken through materials which were buried. The organic recordings were (not surprisingly) the very samples which yielded the greatest number of radionic sounds when "entuned" through the volume control. I have recorded samples in which these variations of overtones (with potentiometer adjustments) are demonstrated. This represents the radionic tuning of sounds through a slide-resistor! I found 2 or 3 overtone bands when testing the tree-root signals.

A critical friend of mine (I have many) cited that capacitance and inductance values could shift these overtones through the subtle tuning effect within the potentiometer. With these audio frequencies the negligible changes in lumped resonance values cannot possibly alter the overtones to such an audible degree. I am sure however that critical analysts will not rest until they have found some corresponding mechanism through which the "living quality" will be revived. When the mind's eye is opened...all is life.

These recordings may be considered as the first truly original radionic sound recordings. They are ultra-rich in radionic potentials and are capable of being entuned through Hieronymus-type analyzers. What these new facts witness is further corroboration of the non-electromagnetic character of these energies. These signals are so rich in organic energies that they allow audibly detected radionic tunings to take place.

I had considered the possible effect of "probe poisoning" of the probe site. I learned with time that each sample requires several

moments before it can saturate with the ground power and achieve material-resonance. Time is required for each sample to reach its constant and characteristic tonal signature. We can actually hear this phenomenon during the course of the experimental soundings. One can hear the very moment at which the probe material becomes "super-radiant". This process seems to involve some form of polarization (but we cannot define the symmetries by which materials polarize) and a certain energetic saturation. We actually hear the spontaneous progression with time. The sudden advent of previously unheard overtones (listen to amethyst!) is evidence of this phenomenon and process. [The key to extracting ground power is the entunement process; through which it is possible to draw all tones into specifically ordained elemental "windows"].

Probes gradually become "energetically polarized"; they take time to reach maximum signal intensity. This is possibly due to a more highly conductive state through which ground power enters both probe and monitoring sys-



tems: a conductivity which is more fundamental than electrical conductivity. The gradual and continual appearance of distinct overtones becomes the evident feature of a subtle and progressive saturation process. I am reminded of similar findings reported by Baron K. von Reichenbach. It is always wise to allow probes to "rest awhile" in the earth before actually monitoring their signals. This feature of great interest (and anomalously unconventional) represents the mysterious self-intensification of received signals over a time period. We find that these signals (once set in the "safe" recording threshold) suddenly thus manifest the "danger point" at the console.

The discovery of tone-signatures provides a potentially powerful diagnostic tool for chemists and mining engineers. Through such means it would be possible to locate deeply buried ores and mineral lodes (from ground levels) through tones which emanate from the subterranean deposits. The tension which enters the probe must be considerable; it is definitely not electric or electrical in its primary form. When handling the probe rods I find that the personal reception of radionic impressions actually becomes greater in power. Furthermore, this personal awareness increases when simply

pointing the probe groundward or along ground ray-lines.

It was intriguing that the handling of the single lead wire (once the sample had reached its conductive state) could produce "micro-phonetic" crackling sounds when once the probe was buried. The sound suggested a strange degree of "high tension" in the thin wire: an anomaly. One critic mentioned that this was an effect of such a configuration... "acting as an electret"; something very unusual with low-voltage "electricity". These crackling sounds suggested a degree of tension in the thin lead-in wire. I yet have the strongest impression that this tension is a formative (crystalline) permeation emanating through the sample material: insensate radionic energy.

Furthermore, the fact that the ground potential energies can "spring" into the monopolar single wireline indicates the vigorous degree to which they are "highly active". This activity also does not seem to require specific "wavelengths" of single wire or "oscillatory tanks". The mixing console is not made to oscillate at those frequencies. In addition I wish to point out that each sample was passed through a loading coil of considerable inductance. The filtering effect of such a coil on high-frequency signals is well-known. I have received soundings through long single wirelines (20 yards) and short ones (1-3 yards) with no difference in received overtones. Critical lengths in the receiving circuitry is not an important feature with this energy. Not requiring any "return circuit" in order to effect their signatures, these energies represent an immense reservoir of subterranean power deserving our investigations in earnest. I infer that the ground-generator (while seemingly inactive) is actually vast in its own (insensate) activities.

LIVING GROUND POTENTIALS

Space does not produce the volume of sound as found in the ground. M. Theroux demonstrates this with his dipolar ground receivers. The aerial rods never produce the same amount of sound as do the ground rods; except when hand held! The best volumes for recording ground-rods were registered when the central core of my lead lines (the shielded part of the coaxial cable) was used and tapped. This is a perplexing feature when interpreting the results from a conventional stance: there is no reason why either the inner or the outer cable portion of the connecting cable should offer such a vast degree of conductive difference to these energies. No "return wire" was made in order to provide a dipolar circuit in my experiments.

If there is a "return circuit" then it is most certainly of rayic nature. Dr. Drown and Dr. Chapman always spoke of this mysterious "auric connectivity" in the absence of conductive lines. Much of radionic apparatus designs

takes these hyperdimensional ray-circuits into account. Furthermore, there is no "ready power" at the console site capable of entering the ground and registering signals. The fact that the varieties of probe materials each are possessed of vastly different overtone content should eliminate these critical considerations entirely. These overtones are not the result of ordinary heterodyning. They continue to appear as constants ... in spite of graphic equalization.

It is well known that the very ground upon which we walk is seething with all manner of ray energies. That materials do not generally emit such kinds of energies (when held aloft) must be better appreciated. M. Theroux shows this repeatedly in his recordings; where only the buried portion of the configuration (when free) releases sounds. Of course Mr. Theroux conducted several experiments when half of the probe circuitry was held aloft (the ground probe was also held); in which case a thundering and dramatic surging of power was at once evidenced. The organic presence makes the difference!

Investigators of "the subterranean deep" have known that ground-energy manifestations are exceedingly more potent than those of upper-space. The ground is indeed a very special reservoir of life-generating energy; a focus of intense dynamics where rays (of intense power) transact and interblend. We are chiefly intrigued with the rayic aspects which thunder, crystallize, and sustain the very structure of consciousness from the indispensable ground. The ground is a vast generator of conscious and living powers; whose componentry consists of metal lodes and mineral deposits through vein-structures. Its caverns are resonators. The nature and regional source of sounds heard "in the head" shortly before entrance into sleep requires a far greater study of ground power surges (which are registered daily after midnight). Immensely powerful rays have been diffracted into the ground strata where they surge in vast and mysteriously insensate transactions. The ground appears to be essentially inactive except to sensitives. Devices and apparatus which seem "inactive" are actually operating at immensely potent degrees of insensate activity: the key toward comprehending future technology. This energy of the ground is primarily an experiential one through which consciousness is mediated into our being. All the other effects of this singular presence reveal the plenary nature of powers which are ours to use. Through the ordained ground points we may achieve and experience deep rayic connections.

Created things (trees, minerals, mountains, lakes, humans...) are both generated and sustained by this grand power. When Victorian science spoke of the earth as a reservoir of energy; admixing the prevalent view that auric

energy was primary to electrical energy. The Victorian emphasis was always upon the vitalistic energies. What we need to pursue are the means through which this energy may be appropriately transmuted into light, heat, motive force, empathic telecommunications, healing force, and mind-expansive potentials.

These new tonal forms offer fresh evidence and insight concerning the "indispensable ground". The power which resides in the ground is potent in giving the listener sudden and impromptu (resonant) displays of extended consciousness. Psychoactive effects began to appear among the discoveries made with tone-signatures.

Effects in which the radionic sensitivities of the body are enhanced through exposure to these sounds was marked. While working with the large carbon rod I experienced a distinct sensation of very rapid (10-20 per second) energetic rotations in the space surrounding the rod. This was especially powerful whenever the rod was pointed toward the ground. I had noticed this aetheric action with other materials

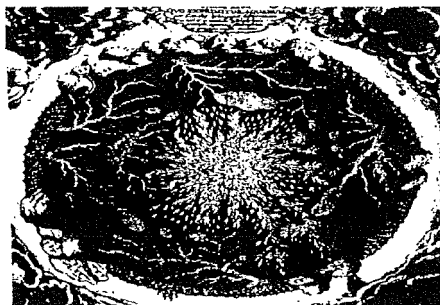

before. I also learned that by specific kinds of "loadings" on such materials (iron ring, copper windings, organic blocks in proximity) that it was possible to slow and intensify this aetheric vortex. In order to test the aetheric potentials of "vortex action" which was felt surrounding the carbon rod, I conducted an experiment in vortex induction. The concept was to attempt the entrainment of electrical energies in a wire helix.

I used an insulated coil wrapped (CCW) around a large carbon rod and buried it (25 cm. deep) with the remainder (50 cm.) standing above the soil level. The coil "wrapping" was made of 200 tight turns of telephone wire in a single layer. This wrapping was single terminated; the ground-sided end was crimped (exposing no metal) and was completely contact-covered by a very thick acetate tape. The free line-end was above ground; this was connected to the monopolar single wire and made connection thus with the console. I allowed this configuration to reach resonance in the ground for 15 minutes before sampling its sound. The results corroborate my claim that an anomalous primary activating energy is entering these arrangements.

The wrapping coil (plastic insulated) formed a powerful combination when coupled with the carbon. This did not impede the appearance of a most unusual (higher pitched) "buzz" along with the original carbon signature. The energy entering the system was strong; but not as strong as those monitored through the carbon alone. This energy is capable then of entering solids and heavily insulated wires alike. These two facts give more evidence which affirms that the primary energy (of ground) is not originally of an electrical nature.

Life-generating energies do not begin as electromagnetic signals. Life-generating energies may leave electromagnetic "tracers" (polarization trails in space) as their energetic presence is encountered. Furthermore, the manipulation of appropriate inertial elements to form electromagnetic polarizations in a space does not imply that living energy will be "summoned" into the core of that polarization: the effect is not reciprocal. In most instances life-generating energies cannot be detected through mere instrumentation; being a space which requires an experiential transaction. Life-generative energies therefore cannot be known except through certain of our senses directly (ganglier vision). Those who deny the subjective element of experiences can never "detect" life.

The generative power is sensed and desired by our beings. To deny its permeating reality is to live in willful ignorance. This power is subjectively sensed and discerned by all who are willing to allow themselves the joy of sensing and feeling with their whole being again. We can detect these energies through our being and can also register their presence through radionic (instrument) tuners; these tuners extend our subjective senses into other (inaccessible) experiential resonances. We have every assurance that cooperative modulations of this power is a singular providence with which humankind has been gifted: to work with the generative power is both our long-lost cultural dream.

ART AND POWER

My fascination with these sounds (as a musician) is epitomized by the eternal ringing of matter in the ground. When I examine the geo-radionic environment I do not experience "the waltz" melodies of romanticism. I do perceive the steady and endless emanation of eternal tones in their wondrous panoplies and combinations. I hear the mysterious joining of sounds ... the permutation of tones through space and ground. Such direct reception is a goal realized. The composers and artists of the twentieth century developed the forgotten arts whereby auric apprehensions were directly expressed. The artistic stylization during this epoch was simply the artist's own receptions of

the ætheric worlds with which contact was made. Each artist expressed a different realm and artistic inflection because each artist is in tune with different space-resonances.

The musician has historically been associated with a process of externalization on behalf of the culture which they represent. Through the musical or artistic gift (ætheric hearing, ætheric sight) the musician is able to express sounds which exist in the environment; and the artist is able to structure living forms which have been located in psychospace. These items are not heard or seen by most persons (although many do anticipate and apprehend them in some minimal manner). Expressing the sights and sounds of the geo-radionic environment was a lost art. The emergence of bourgeois artforms (catering to the aristocratic courts of Europe) plunged the world's population into a "belle epoch" of frivolous self-indulgence.

The lost art of directly expressing the ray-auric sounds of the universe (Pythagoras, Fludd, Messaien, Ligeti) has re-emerged with explosive power. The conflagration which accompanied this re-emergence (1900) caused some degree of dismay among the romanticists and impressionists. The biopathic inability to receive the higher dimensional sights and sounds of expressionism is ample evidence of schismatic human perception. The consequent social structures which have evolved as a result of this schism is easy to identify and group. There are those whose stubborn fixation on emotional content and is sufficient evidence of rigidified and maudlin armoring; an unwilling fear of directly experiencing the true life of the universe without traditional masks, acceptable shields, or bourgeois pretense. Therefore I find this ground noise and matter-noise most fascinating and revelatory. With the rediscovered art comes a forgotten awareness. The frivolous artforms which do not connect us with the universe are self-referential and self-centered. The proliferation of bourgeois music and art entraps those whose attentions have been captivated into auto-emotive loops. The power of an art cannot be separated from its "place of origin". The higher the dimensionality of artistic revelation, the greater the ability of that artform to translate the participants thereof.

Any artform is inseparable from its origin and its power to change lives. The vague and frivolous nature of weak derivative art reveals the degree of revelation which spawned the form. The loss of true connectivity with the living generator produces much of the mass-produced artforms which have flooded our society. Furthermore, those whose lives reflect loss of connectivity with the true and living generator are incapable of appreciating or accessing the pure expression of ætheric worlds. These individuals do not have the spiritual credentials or qualifications to speak. Having

no comprehension of the geo-radionic environment and its powerful conscious permeations these persons live out their ignorance while operating through clotted emotions.

VITALISM AND INERTIALISM

The academic professions are known for their stance on subjective and experiential science: they refuse to "feel, sense, or experience" any phenomenon in the universe. With this "no-feel, no-touch, no-sense" doctrine they have effectively separated themselves from the very heart and meaning of the universe; while professing to know all about it. The excessive descriptions with which they dazzle the naive betrays their essentially vacant experience of the vibrant universe. To merely measure and describe is not essential to our being; or capable of addressing the true need of humanity. There is a message which is vacant as is their experience of the universe. They know nothing of the deeply ancient, enlivening, intelligent, and exotically sensual potentials of space itself.

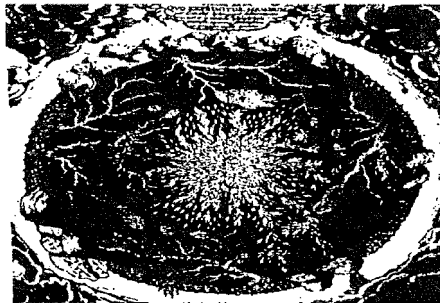

What sensations and experiences academicians disallow is actually the essential message, meaning, and joy of being in a living: to deny this is to be insensitive and deranged. Through such biopathic dictates "against sensation" the academes have effectively blinded themselves from directly experiencing worlds which supervene and dominate those which they claim are central to the universe. The academe is not aware of the permeating domain through which all true cause emanates: the real source of the effects upon which academia fixates. This is the very rift which irreparably separates us from them. We reject any dogma which indites or disapproves of subjective sensations. We object to all such rule and will never concede our ground: they must come to us. A new barrage of anomalies has emerged from the domain; these will not be understood by academia.

In the matter of ground-power and radionic emanations the academe has been limited. The totality of academic expertise in these regards is pressed between two very narrow descriptive studies: "contact-potential" and "telluric electro-currents". Within these two exceedingly narrow blades they have succeeded in satisfying all of their fears that a living

earth actually exists! Measurements of the pressures resultant through the "contact-potential" of metal probes in the earth judge any and all measurable electrical potentials to be the mere result of electrolytic actions (metals-soils).

The second peephole through which they claim knowledge of the organized subterranean depths is summed in their measurements of "telluro-electric" pressures and currents. Geophysicists have charted and mapped many varieties of these currents for nearly a century now. They have a thorough catalogue of the directions and potentials involved in these minute and surface leakages. Telluric currents represent the smallest fraction of a far more potent primary causative energy through which all these effects are manufactured.

Telluric pressures of inertia represent the mere fractional (electromagnetic) "debris" of a primary generative presence. This energy (being radionic rather than electrical in essence) is not prized for its work-performing ability. What we derive from this energy is primarily its revelatory potential: ideas, images, visions, symbols, melodies, designs, archetypes... "buried treasure".

I have analyzed the comments of my critics to a degree which prevents them from convincing me of error ... or of damaging my continual joy. I have too often "given place" to such conventional analysis to my own detriment when young and inexperienced in these matters. The academe is a parasite whose discussion can closely parallel those of the vitalist; since inertial effects often simply follow vital causes. Inertialistic science is fully capable of shadowing the vitalist's progress and discoveries. This may be understood by studying the path which vitalistic discovery actually takes.

Wherever there are vitalistic potentials at work in the universe there can be inertial responses and effects. While these do not truly parallel each other in all cases there is somewhat of a correspondence between both the causative domain and the realms of "effect". Inertial effects do not always follow Vital Causes because of the limits of space-resistance. Space-resistance is the experiential interface through which vitalistic potentials pass. The interaction of vital rays with the space-resistance results in the manufacture of inertial polarizations and detritus. These alluring displays have captivated academicians for centuries. Without recognizing their error, the academes has continually attempted the description of reality from this manufactured level. Mistaking the effects for causes results in a singularly interesting (and annoying) human situation. We find that insensitive individuals are now making cosmological declarations which are entirely unfounded. Furthermore, the amplified inability to sense vitalistic causes (rays and their auræ) among the academes rigidifies their unwillingness to reject the manifestations to

which they so passionately cling. This erroneous confusion between phenomenological cause and effect has torn the human community. Power struggles ... for domination, wealth, masteries, and acquisitions .. have resulted in the realm of human experience. The damaging results of inertial technology are ever-present.

The instances where no inertialistic explanation can follow vitalistic causative action are excessive. The inertialistic "explanations" do not reciprocate the living cause: one cannot arrange a mechanism by which living potentials may be experienced. This was the (Victorian) "problem" when academicians attempted the regeneration of the dead through (mere) electrical means. Similar theories would insist that a simple mechanistic evolutionary process is responsible for all species. It infers that powders (taken from the crushing of a working watch) could regenerate a working watch ... after suitable agitation.

There are sensate realities (sensitivities) never known by the academes; causative worlds of living sense and experience. Such ignorance and insensitivity is typical in the pattern of biopathic anæsthesia. In this regard there have been more profound episodes: where significant vitalistic evidences have been totally "forgotten", lost, and actively denied by academia: the very history of suppressed science and technology.

There are those instances where radionic activities do not register in any existing inertial meters; bypassing the space-resistance through which inertial effects (polarizations and detritus) are registered. In a mysterious manner such phenomenology indicates that the joys of radionic activity are reserved for those who willingly experience them. The central core of meaning and life is an experience ... not a measurable quantity or a mass of alienating descriptions. Inertialistic understanding relies totally upon the measurable (dead) effects initiated by primary (living) cause. Where no effects are produced the inertialist then dictates (usually vociferously) that "nothing is there". Poor Monsieur Blondlot ... you did see and experience the N-Rays!

DISCUSSION AND CRITICAL ANALYSIS

I have gradually realized that the important overtones in this research represent a real instance where a pivotal vital-inertial nexus has been found. The correspondence of tone and overtone, cause and effect has revealed a class of new phenomena for study. The fact that each overtone dance is material-specific offers a fresh anomaly to baffle the academicians.

It is impossible to have predicted that different materials (placed in the same ground) would produce such different tone-signatures. It is only through empirical activity (with an opened and subjective attitude which allows

such discovery. Each probe sample is found to give its own range and kind of overtone content. There should be no difference in tonal content regardless of the kind of probe used. The only expectable difference would be the one which controls "signal volume" and that would be the result of variations in probe resistance.

If the tones were mere result of electrochemical reactions between the probes and the ground we would not expect the audible differences among such tonalities. There are several reasons why can eliminate the possibility that these sounds are developed through the electrochemical "frying" or "frizzling" of the probe surface areas (in ground contact). According to convention we would have to accept the view that different materials are capable of sudden conductivities "because of electrolytic action in the ground". They would argue that the specific electrochemical reactions of a material in soil would produce specific "sizzling" and "frizzling" sounds in the monitor; as each



chemical reaction differs from the next.

If I showed them that ungrounded metals (merely placed in acid cups or in elevated pots of soil) would never produce these recorded sounds ... could they then believe? Inertialistic understanding relies on effects. Where no effects exist they conclude that no cause exists. The conductivity of any material alone could never allow such sudden (and markedly different) tonal appearances of overtone groups with different probe-materials. The sheer volume of sound received is in no way corroborated with the relatively unreacted face of the metals after their short spell in the ground. In addition, I have received just as powerful and as variegated tones through glassy substances which do not react with the soil in an electrochemical manner.

Each material used gives a different "overtone song" only when buried in the ground. Emplacement in acid, water, or pots of soil does not produce the sounds. Aerial elevation of the materials has not yet produced the sheer volume of sounds received unless the human organism (or any living organism) is present near the receiving device.

According to the conventionalists, no difference of signals between different materials

should have been monitored at all in any of these experiments. The surface area of receivers does not increase the overtone volume levels or their content. These experiments answers those who speak of electrolytic reactions with regard to our research. I buried a group of separate carbon rods and interlinked them with wire. I fully expected these to provide me with ten times the output sound and signal (since I used ten rods and was provided with ten times the electrolytic surface area). They did not offer an appreciably louder signal. Neither did the overtone song alter. Anomaly again.

It is significant that tone-signatures do offer very different "dancing" overtone signals. The astounding feature of all these recordings is that (over the several tracks made) the probes were in the very same ground spot in the very same hour. Groups of these samples were made in this manner. It would be difficult to comprehend how the great variety of signal-forms could otherwise be generated. Out of the very same ground come different tone-signatures... the result of different materials placed therein.

The significant overtone songs which differ from sample to sample cannot be the mere result of locale or time. One cannot say that "suddenly" there were "teletype signals" or the like within a sounding. Each one is possessed of its own characteristic overtone song which remains fixed for that sample. Exposure to ground-rays activates these releases.

If some local effect of electrical leakage (whether into or out of the recording system) were to blame for these species of sounds, we would expect only variations in amplitude and a constant sound in each sample. This would follow the conventional explanation where varied resistances of the probe would effect changes in volume of a constant tone-signature. This is not what we have discovered however; with each material there is a special and distinct earth tone signature.

These sounds are only activated through contact with the ground itself. When they are elevated above the ground they do not emanate any tone-signatures which can be detected. This is evident in the recorded material of M. Theroux as well as among my own recordings.

THE MASTER TONE-SIGNATURE

The sounds of 60-cycle A. C. offer a background "dull hum". We may hear the sudden dull sound ("dmmm") of local appliances turning on and off in the neighborhood in certain samples. Their entrance and exit do not alter the fixed tone-signatures of each material. The presence of 60-cycle induction cannot be ignored. Yet, we have found these levels to be so easily recognized that we (initially) made our discoveries in spite of their slight presence. The 60-cycle "hum" and all its

harmonics (low or high) are all of the same tonal variety: a "dark" humming sound.

The enormous volume of living background noise is problematic for most analysts; whose biopathic reaction to these tones is both characteristic and predictable. These individuals will tend to focus their attentions upon the merely inertialistic pressures resultant from the primary generative energy. Studying the effects which are manufactured by primary cause is the inertialist's scientific specialty: they know the effects very well. Unfortunately the mere knowing, describing, and predicting of effects does not reciprocate or translate into "life".

When we eliminate the 60-cycle hums and their harmonics from these tracks we find a pre-eminent signal permeating all of the tone-signatures: the master tone-signature. This is an ever-present tone-signature which we cannot ignore or misinterpret. I believe this tone-signature may vary with locale; by which we may also map and chart regions in a new awareness. The greater portion of this signal (which buzzes and rattles with such enormous throbbing power) is not the result of human technology. Isolating this signature of the ground from the sample tones is impossible. Simple adjustments with the graphic equalizer can eliminate the effects of inductive leakage but cannot block the signature-overtones of a material.

The generative power of earth sounds is enormous. They apparently remain potential (silent) until given a material into which they may flow. This flow is specific and distinct for each material-probe buried in the ground; evidenced in the specific overtones which are discharged. Furthermore, the overtone songs are not easily isolated and amplified through the ordinary means of graphic equalization. Their ephemeral and permeating presence is heard "across the full spectrum". One may eliminate any frequency band and yet find the shadow of the overtone dance present. This persistent feature is truly anomalous. The overtones ride above the master tone-signature in a distinctive dance pattern through which materials may be identified. They offer a spatially disposed behavior when heard. This is why headphones are an imperative when listening.

Electrical appliances (locally used) do not cause the sharp and irregularly syncopated impulses which are heard throughout the recordings. There are "racers" amid these constant throbs whose independent and separate rhythms permeate the background noise. The "racers" are characterized by a great variation of separate and continual rhythmic speeds: these cannot be the result of 60-cycle leakages or the use of local appliances.

Interference from powerlines, ground connections, radio stations, telephone cables, "military signals": these are not the overtones upon which we are focussing our attentions

and discussion. When all the effects of such "electrical poisons" are filtered the sound volume is still enormous. Induction and leakage would produce the very same sounds in all samples. The only audible difference would be confined to differences in output volume: the result of variations in conductivity. Tone-signatures are element-specific and possessed of overtone features which are found throughout the collection of elements.

EXPERIENCING TONE-SIGNATURES

This new field of tone-signatures is a door into the future. It provides us with accessible vision into the otherwise unknown subterranean earth. The constancy of empathic activity in matter requires no "measurement" by those who are sensitive to their activity. The human organism does not natively require transformations from rayic to electrical effects in order to "validate" the existence of anomalous energies: we are fully capable of directly detecting them with our deepest senses. It is merely academic conditioning which "disallows" the existence of activities which each of us can plainly discern. The divergence between academic measurement and radionic experience defines the schism between our factions.

PLEASE USE HEADPHONES WHEN MONITORING OVERTONE SIGNALS OR RECORDINGS!

There are enough of the various samples placed on the sample cassette so that the student may apply whatever lab-diagnostic techniques (overtone analysis, graphic equalizers and filters, oscilloscopes, etc.) required. The full appreciation of these overtones is experiential. Lab techniques may not reveal what the human organism alone senses and experiences. Lab tools can never impart or partake of meanings; which is the human providence.

The delicate nuances of tone-signatures can be transmitted through cassette tape; but requires headphones in order to detect the subtleties of overtone movements. These overtones are heard at the very peaks of our audible range. They ring, whistle, and warble with specific patterns which depend on the matter from which they were derived. The spontaneous stereo phasing of the overtones is a thing to be felt and enjoyed. It is my sincere hope that you will spend enough time with each sample to experience the significant and marvelous motions for yourself. It is my deepest desire in these regards that you each experience these tone-signatures and relinquish the "diagnostics of doubt" which separate from you direct experience.

Listen to each sound and savor the overtone motion which rides the background noise. Listen "above" the master tone-signature. Eliminating the soft 60-cycle harmonics is relatively easy. The resultant throbbing undulations of

the ground will not be easily suppressed without the graphic equalizer on your stereo. You will be amazed to hear the "overtone song" which is the essential tone-signature of each sample. It does not vary considerably with graphic equalization.

Focus your attentions on the overtones which you hear "riding above" the other sounds. You will find that these will touch you... at the chest, neck, and facial areas. This represents the empathic signal which enters the ganglier sensors of your body directly. Do not be surprised at this phenomenon. Listen to the "warbling" overtones of each sample: they are each different and constant for each sample.

Listen and absorb the track where I have "balanced" iron against carbon. The experience of this combination is like being physically connected with as powerful an earth battery as that which Anton Mesmer constructed! Let yourself feel its powerful energy moving through your body from right to left.

The background noise is not the important feature here. Allow your awareness to focus only upon the warbling overtones which ride above the other sounds. Examine every warble with your whole being. Learn to depend on your senses again. Experience. Stop demanding the analytic tools which separate you from direct sensation and meaning. It is the doubt concerning radionic reality which forces humanity into inertial observation. Stop doubting and know.

Dan Winter is a very dear friend of mine for whom I have extreme admiration and respect as a researcher (stunningly successful work on Dirac Waves, Moray diodes, C.E.S. devices, and bibliomancy). In the course of our long-time association we discussed the many features of ground energies. It was he who first suggested that I try slowing the speeds of these ground tone recordings down through successive steps. When I engaged this procedure I was absolutely astounded to discover an unsuspected world.

By recording at the very highest speed, and then successively fragmenting the tracks, I was able to produce ever slower versions of the original. In several instances I used the method of recording at highest speeds (19 ips) to make the original master copies. I then re-recorded each track at successively slower speeds (1/2 master speed for each deceleration). The result is an astonishing succession of ever-decelerated playbacks. I finally reached 1/32 master speed with the gradual approach of distortion entering this last step. The disappearance of lowest audible pitch with slower speeds is only made more mysterious by the sudden appearance of nearly ultrasonic pitches. A pitch which measures a clear 10 KHz. pitch at these speeds must be an original 32 x 10 KHz or 320 KHz: a true mystery!

Each harmonic drops down (from inaudi-

bly high registers) "into view" when the tracks are slowed to this degree. Each such harmonic must therefore have originally been nearly ultrasonic in pitch. I would never have suspected their existence in the tone-signatures made were it not for the successive decelerations of the major tone-signatures. But these recording machines of mine are not supposed to be capable of responding to such extreme tones. Furthermore, a definite mystery persists throughout my 1/32nd speed recordings.

It has been suggested (by conventionalists) that the background noises and rhythmicities are man-made; the mere result of local appliance use. If these sounds were the result of ground leakages, then I would expect silver to receive more of the signals than others (including vacuum). This in fact is not what has been discovered. I find it very difficult to believe that any appliance is capable of emitting the "...8-PAUSE-PAUSE-8..." rhythms which carbon so dramatically emits. In addition, the overtone discharges are not the same from sample to sample. Each element emits a different overtone pattern. Some overtones dance with a specific rhythmical emphasis. There is no precedent (to my knowledge) for these tone-signatures.

These radionic tone-signatures are capable of remaining in the magnetic recording medium (magnetic tape) in a permanent manner. If all these manifestations were the simple result of induction, electrolytic "battery action", or varying degrees of "conductivity" there would be no tone-signatures. The fact that these tones are radionically charged is quite enlightening; offering us the privilege of discovering and experiencing new worlds. There are sudden emissions which spontaneously release very sharp "pings" of exceptionally short duration. Not all materials do this. Amethyst, sphælerite, pyrite, and galena seem to evince these sudden sharp tone emissions. M Theroux discovered these in enormous volumes out West. I see these mineral tones as being akin to forced radioactivity under the impact of the ground-ray (see works by G. Le Bon).

With the graphic equalizer alone it is impossible to isolate the overtones. They are mysteriously a part of the "whole signal" and "dance" among the major tones heard per sample. You must listen to these by directing your attention to the very highest sounds heard "between" the headphones. You cannot isolate or eliminate the overtone dance with the graphic equalizer.

None of the mineral samples were touched or handled during the sampling period. None of the other samples were handled with the exception of the hand-held coil). The crackling sounds you hear are their natural outputs. In addition, all the single wire lines were carefully insulated and avoided; no motion took place in the laboratory. The absence of automobile

traffic makes the constant crackling noises more suspect of anomalous source.

Allow your attention to be drawn into the overtone dance": these contain the empathic signals. They seem to hover above and upon all the other sounds. Each overtone "dance" differs from substance to substance. Through them we become empathically entwined with the aura of each sample; savoring their essence directly. Through such a means we may (personally and intimately) experience the minerals and metals in a way never before possible by knowledge alone. Extending these experiences into the tone-signatures of stars and planets is my next experiment. Then comes tele-empathic research: the development of technology through which we may experience distant communications of an experiential variety.

The complexity of the sounds are difficult to specifically analyze; and must be heard, rather than described. The tape is made for purposes of subjective analysis and study. Remember that none of these recordings were made with any kind of "tuning" in the regular (radio) sense. The only tuners were the potentiometers of the Yamaha recording console; and these had an appreciable effect on the tonal varieties throughout the recording and the playback! Potentiometers act as radionic tuners, and represent the use of crystalline carbon as an organic detector. This is not surprising, considering the affinity of earth tones energy for carbon.

I have purposely made the recordings long enough so that students can sample enough of the soundscape to familiarize themselves with the long-time transients which roll and flutter through minutes of time. The most unsuspecting "buzzing" contained such a vast degree of tonal complexity, that most researchers have simply discarded these sounds. Certain steady pulsations (too deep to hear) can actually be tracked while watching V.U. meters. The great varieties of overtones is a surprising experience. The new student of these wonderful radionic phenomena will derive great discoveries from these modest beginnings. The pulsations from the pickup

or the ground-rod system are remarkable. I provided one minute of each sound sample for the listener. No doubt, there are other ground arrays and "ground-organic" configurations which must be sampled for their additional overtone content.

One may use the samples for subjective (empathic) analysis, or for use in conjunction with radionic tuners. In the case of either, the rationale of offering long samples is to allow sufficient time with any specific sounding to perform needed empirical adjustments and diagnosis. The sounds give a definite sensation throughout the space they are listened in. The foremost fact to remember concerning our ground recordings is that these signals are +-musical overtones. Be amazed and be opened. Let the sounds move your thoughts where they will. I assure you that you will experience far more than you yet realize through discussion alone. Determine the ray-lines which pierce and penetrate your neighborhood. These sounds should help reveal these ray-lines: by travelling into them and activating some of their potentials. Such experimentation will lead to breakthroughs in our ability to extract naturally occurring non-electrical energy from the deep strata in the ground. Such energy interactions will (with new materials and new tuners) permit the local release of light, heat, cold, motoring, therapeutics, astral travel, teleportations, transvision, direct-coupled learning, and all the potential future needs of humanity which are indeed generating and surging... within the ground.

BEST KEPT SECRET IN SCIENCE...

Nikola Tesla

— *The Man Who Invented The 20th Century.*

Inventors, investors, educators, scientists, engineers, students, businessmen.... anyone who is interested in seeing science and technology stretched to their limits, attend the **1993 Extraordinary Science Conference!!!** Watch as our speakers bring forth what may well be the foundation of the next century's technology base... as Nikola Tesla did 100 years ago. Determine for yourself the validity of our speakers' claims as you observe them demonstrating actual models!!!

Get a glimpse of the FUTURE Today!!!

Attend the 1993 Extraordinary Science Conference

-- July 22- July 26

International Tesla Society
PO Box 5636
Colorado Springs, CO 80931
Or call (719) 475-0918





R. Murray Denning

MY SEARCH FOR RADIONIC TRUTHS

by R. Murray Denning
Book Review by Alison Davidson

“Another book on Radionics! That subject which is a scientific tease to those who work in it, and a scientific anachronism to those who work in the orthodox world...”

... so Mr Denning introduces this work that should find a place on the bookshelves of Radionic practitioners everywhere. Over 25 years of research into the whole spectrum of healing have been focussed here, with special reference to those Radionic practitioners of the past whose gifted minds helped shape Denning’s own path. But this book also provides a missing link in Radionics, revealing some of the ‘lost’ knowledge in radionic history, as well as projecting this art into the future where it will be able to take its place side by side with the medical profession.

“I have always maintained, and still do, that if one is working on a sustained campaign for universal medical recognition, the fact must be faced that it will not come about unless there IS a sound scientific background.... I examine and enlarge on this statement in my book, explaining in which way I feel it can be achieved.”

Denning’s first encounter with ‘unorthodox’ healing was quite dramatic. He was afflicted by an ‘incurable’ spinal complaint which dominated his life for 25 years, until at the age of 45 he met and was cured by a remarkable healer working in a London Spiritualist centre. This experience changed the whole course of his life. Here lay the beginning of his adventure into Radionics and healing, and also the way to realize his dream – that one day science would prove Radionics to be true.

WHAT IS RADIONIC THERAPY?

“It is a form of ‘Absent Healing’ by the use of a ‘Force’ or ‘Energy’ in conjunction with instruments.

“What is this energy and how does it manifest? To the first part of the question the answer is that this is unknown. There are, however, some men and women who, when they have reached a certain point in ‘inner development’ do know what it is, yet are unable to describe it in terms acceptable to science. Others accept its existence intellectually, though they too are unable to define it. Still more people can use it without experience or understanding.

“It has been called many names, e.g. Reichenbach called it Odyle; Reich, Orgone; Paracelsus, Munia; Eeman, X Force; Alchemists, First Matter; Theosophy, Fohat; Alice Bailey, Cosmic Fire.

“It is the Energy that manifests itself through all forms of expression on earth; through physical form with all its complexities – physical, chemical, biological, electrical, magnetic etc, and through the etheric and subtle fields of which life is composed. It is the Energy that flows through the hands of a ‘Healer’; which is

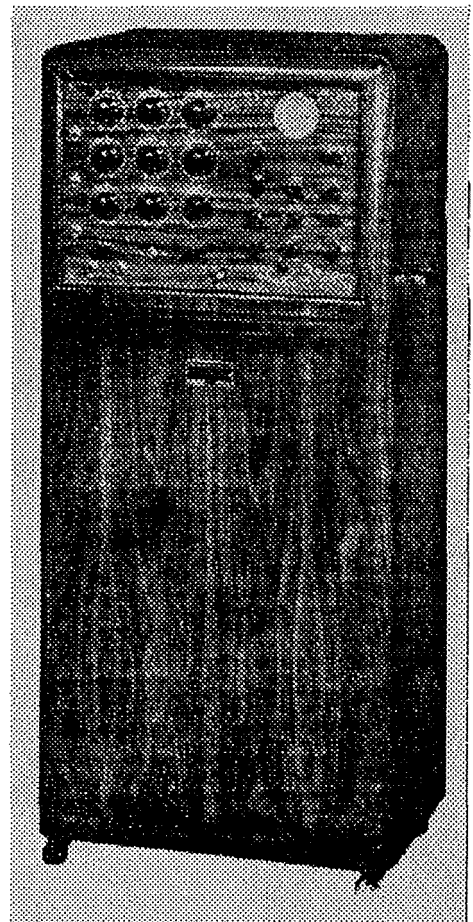

Drown Mechanical Detector
Model A-458 - Complete Office
Model, 3 inch screen oscilloscope.

released through the shape of the Great Pyramid; through geometrical and numerical patterns. It is, in fact, Cosmic Energy.

The pioneers of Radionics often spent their whole lives experimenting with this Life Energy and Denning pays tribute to the great value of their work, giving fascinating insights into their lives and discoveries, as well as taking the reader on a journey along his own search for Radionic knowledge.

"The works of the pioneers, particularly for those who have not had the opportunity to study them deeply are of absorbing interest. Their approaches to the development of healing techniques varied from individual to individual, but in the ultimate all were striving to a single end — that of alleviating the disabilities of mankind."

THE PIONEERS — ABRAMS AND DR. DROWN

"Strangely, the expounders of some of the great new ideas of history were frequently considered on the lunatic fringe for some or all of their lives. If one stands up and is counted from time to time one may be knocked down. But remember this, a man flattened by an opponent can get up again. A man flattened by conformity stays down forever."

Dr Albert Abrams was born in 1863, and became Professor and Director of the Medical Clinic in San Francisco. He inherited a vast fortune from his father but decided to devote his life to medical research. Commenting on Abrams' work *New Concepts in Diagnosis and Treatment* Denning says:

"Firstly, he expounds in great detail matters concerning vibrations emitting from the body, both from the physical and 'inner' points of view. And although his work does not stress the occult teachings, his knowledge in this field must have been extensive."

In Abrams own words: "The present age marvels at man's conquests of the forces of nature. Yet, this age of energy can only be triumphant when man can know and then direct and control the more important forces within himself.

"Dis-oculting the occult will be possible when one attains a better understanding of the activities of living cells and when the biologist shall know the laws that govern cell-growth with the accuracy of the scientist knowing his laws."

Dr Ruth Drown also worked to bridge the inner and outer worlds, to provide a link between occult knowledge and scientific experiment. As a student and follower of this remarkable woman Denning devotes a chapter to her basic techniques and philosophy. From her book *Theory and Technique of the Drown HVR and Radio-Vision Instruments* he quotes:

"Very ancient writings deal almost wholly with the rates of vibration of all things pertaining to the mental and physical world of mankind. It is impossible to diagnose and treat the physical body without relating it to the mental. After two years of using our ratio instruments, we found in the deeper study of ancient wisdom amazing and satisfying corroboration of our own development of rates and vibration.

"Obviously, a complete and scientifically accurate 'blueprint' of the condition of the patient's body is of inestimable value to the doctor. This is possible to obtain with the HVR Instrument, since it may be tuned in to any part of the body for measurement of function and for disease. In fact, measurement of function of the glands and

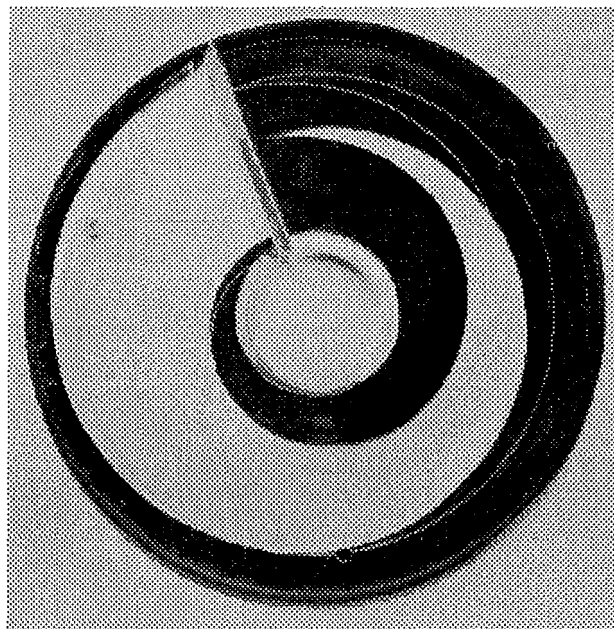

Inner Plate of Meter I

organs in the body is the fundamental basis on which a diagnosis with this instrument is built."

TROMP, LAKHOVSKY & CRILE — DOWSER, PHYSICIST & SURGEON

Another chapter is given to Professor S. W. Tromp, a geologist not so well known in Radionics, but who

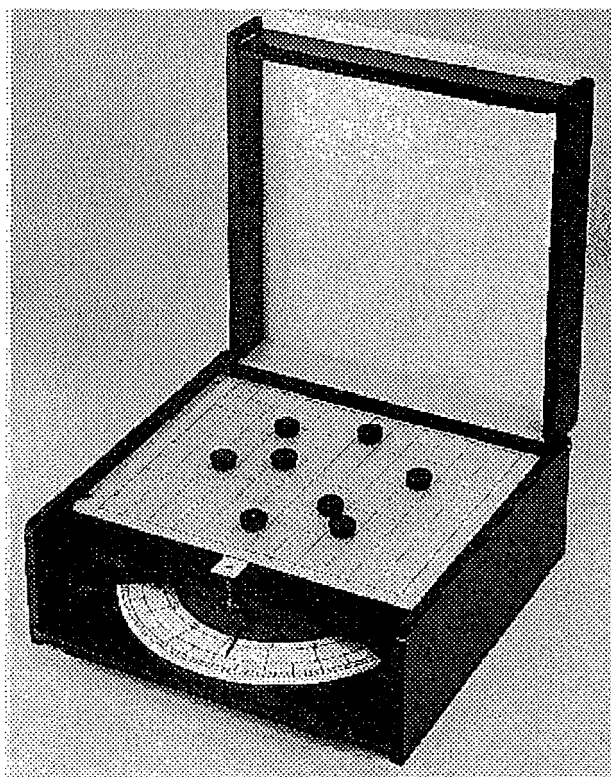

Pegotty Instrument and Meter

performed extensive experiments in dowsing and exploring the electro-magnetic fields of the living body, the earth and the atmosphere. Tromp proved that Radionics could be explained on a scientific physical basis.

Denning felt that his contribution was of such importance to the field that he gives extracts from his book *Psychical Physics – A Scientific Analysis of Dowsing, Radiesthesia and Kindred Divining Phenomena* to enable a picture to be formed of the depth of his researches and his conclusion that Radionics is not a para-psychological therapy having no basis in physics.

Others were also experimenting with electrical energies and force-fields. Lakhovsky and Crile were coming to similar conclusions from very different areas of research. "In his admirable book entitled *The Phenomena of Life*, Dr Crile points out that electrical energy plays a fundamental part in the organization, growth and function of protoplasm. Lakhovsky and Crile, pursuing their investigations independently, have come to identical conclusions.

"While the engineer physicist was experimenting with his oscillating circuits, the surgeon was testing in his clinic the principles of radio-electricity. The foundations of Lakhovsky's theories rest on the principle that life is created by radiation and maintained by radiation. Crile states that man is a radio-electrical mechanism and stresses the significant fact that when life ends, radiation ends.

"Like Lakhovsky, Crile holds that living cells are electric cells functioning as a system of generators, inductance lines and insulators, and that the role played by radiation and electricity in living processes is no more mysterious in man than in batteries and dynamos."

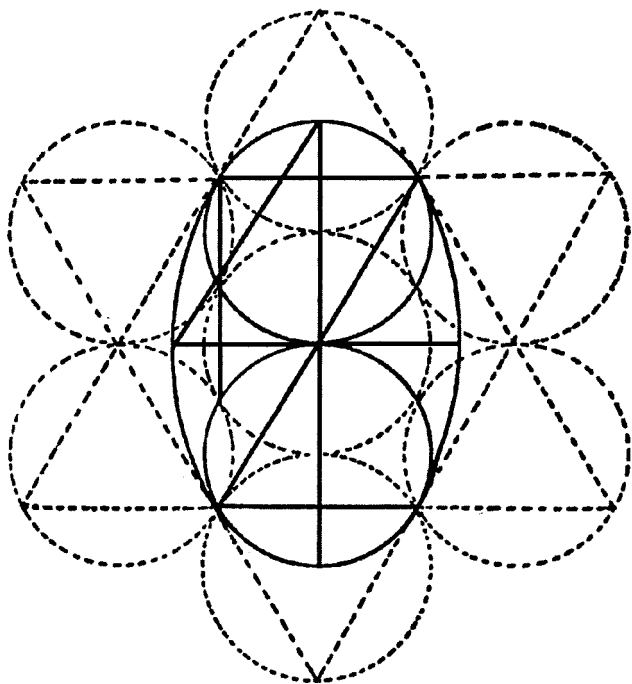

Key to the Cosmos and Numbers

FROM THE ARCHIMEDIAN SPIRAL TO MOGEN DAVID TRIANGLES

Darrell Butcher – "Creator of the First Automatic Radionic Instrument" – spent much of his life as an aircraft engineer, a career which proved invaluable when in the 1950s he became interested in Radionics.

"In the beginning he found himself unable to use the conventional means of registering the Radionic impulse by 'stick-pad' or pendulum but where most men would have given in and sought another field of endeavour, he, with his creative faculty and technical skill, overcame this obstacle by the simple expedient of designing his own very personal instruments. Some, at least, appear to work entirely on their own, whilst others make use of the operator's mind." The Principle of the Archimedian Spiral runs through all his work and can be seen clearly in the design of the Meter I.

The Pegotty Instrument consists of a black perspex box frame with a white top marked with a rectangular design and divided into 120 squares. Each square has a small hole to take a round black peg. When a transverse beam of light is reflected across it, then a message can be reflected onto a nearby sample.

As the Archimedian Spiral inspired Butcher, so the 'mysterious Mogen David Triangles' provided a key to the work of Dinshah Ghadiali. "A book on Radionics would be incomplete without a chapter on colour," Denning remarks. "I have therefore chosen the work of a quite remarkable man, born in Bombay to a family of Zoroastrian faith, who lived a life of astonishing scope and enterprise."

Among other achievements Ghadiali wrote the three volume work *Spectro-Chrome Metry Encyclopedia*, and was associated with Thomas Edison, Nikola Tesla and other noted scientists of the 1890s. His Theosophical studies provided the key to his work on colour therapy.

As Dinshah wrote: "I looked into effects to trace causes; I looked into causes to find the effects. Working on the foundation that all actions must have reactions and all reactions must be preceded by actions, I laboured – with all the means at my disposal; to obtain the answers to the questions, many of which were enigmas for centuries and by the time I solved the problems or cut the Gordian Knots, Spectro-Chrome was born."

FROM RADIESTHESIA DEEPER INTO THE MYSTERIES

Radiesthesia – translated literally from the Greek means 'sensitivity to radiations'.

Marguerite Maury took up a study of Radiesthesia after studying physics in Vienna and then becoming a fully trained nurse. From the Foreword of her book *How to Dowsse, Experimental and Practical Radiesthesia* Denning quotes:

"She developed her powers to the full and tells me that during the course of fifteen years she had carried out more than 70,000 diagnoses and made numerous locations for water and minerals... With the help of some collaborators she founded

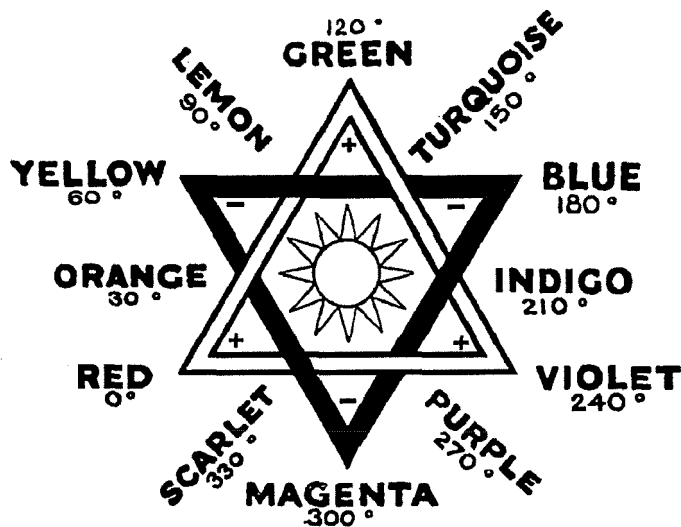

Spectro-Chrome Color Arrangement

the College Radiesthetique Francais and drew up a course of instruction by correspondence which has been followed by more than 900 pupils."

Denning includes extracts from this correspondence course with her special emphasis on Form and Geometrical Figures. Studying this work led him into the significance of numbers... fundamental to all Radionic systems, "the very nuts and bolts of its existence. Whether they are regarded as key links to a psychic plane or as creating scientifically regarded radiations is a personal conviction often debated in Radionic circles."

His quest took him deeper into esoteric lines of thought, that the principles involved in the meaning of numbers are also the keys to understanding the natural laws of the universe.

He contacted Ruth Drown several times asking if there was a fundamental law by which she had arrived at the numbers for her Radionic work. Eventually she wrote back saying: "I have worked out a comprehensive study on the numbers of the Qabalah, which, of course, go back to the very essence of Life itself. It seems quite true that people are using these numbers in what they call a *code*."

It was to this 'code' that Denning turned his attention, pursuing the ancient knowledge concealed in the Hermetic Arts of the Qabalah, the Tarot, Astrology and Alchemy, exploring the universal language of symbolism and its practical application in the world. Concerning the Tarot he quotes Dr Paul Case, the founder of a modern Western Mystery School:

"Tarot is a pictorial text-book of Ageless Wisdom. From its pages has been drawn inspiration for some of the most important works on occult science published during the last seventy-five years. Its influence on the minds of a few enlightened thinkers may be traced throughout the history of the modern revival of interest in esoteric science and philosophy."

The Tarot and the Qabalah are inextricably interwoven

and the diagram which Denning gives (top of facing page) is the basis for the construction of the Qabalistic Tree of Life, the key glyph to the meaning of the numbers so vital to the Radionic system of 'rates' and radiations and the fundamental harmonics of sacred geometry.

Another occult code Denning explores is the cryptic language of Alchemy, "the mediaeval chemical science, whose great objects were the transmutation of the baser metals into gold; the discovery of the universal cure for disease and the means of indefinitely prolonging life." He compares the operation of the Great Work of Alchemy with the stages of spiritual unfoldment as taught by the many branches of Yoga. From the Western Tradition he meets with the East and finds the same message in each:

"That the person who has discovered and learnt how to manipulate the internal forces will get the whole of nature under their control. But first we have to start with our own nature."

As Denning points out, it is up to each practitioner of Radionics whether or not they wish to consciously pursue a system of esoteric teaching. "As often happens when one comes in contact with Radionics, one is suddenly confronted with possibilities of deliberately developing one's sensitivity. For many this is not a major factor, and it must be made clear that one can become an excellent Radionic practitioner without esotericism."

RADIONICS & SPACE-AGE TECHNOLOGY

"Today Radionics is facing a new challenge – that of assimilating itself into a galloping technical and scientific age. It must adapt and quickly if it is to be recognised as a natural segment in the general healing spectrum of the next quarter century and beyond."

Denning believes that the will and the means to adapt to space age technology exists and he foresaw the use of a more advanced form of radionic computer as great value in storing all the information needed for rapid analysis, instantly accessible to the practitioner. But he always stresses the 'human factor' in modern Radionics, allowing practitioners to make full use of their higher intuitive faculties while taking advantage of modern technology to remove much of the labor involved. In conclusion he writes:

"The very survival of Radionics over three quarters of a century is encouraging in itself... The will is there, so are the young people who will be its catalysts. They must be encouraged and helped, since it is by their efforts that recognition will come."

This review first appeared in the January-February 1986 Journal of Borderland Research. R. Murray Denning passed away in 1988.

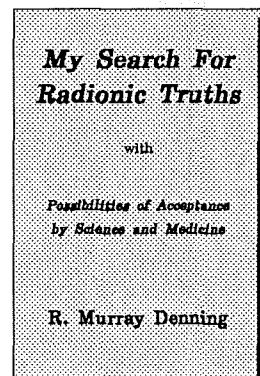

TOYS OF JUPITER?

THE JEFFERSON MARKET MARKET GEOACTIVE ZONE

©1993 Eugenia Macer-Story

I first became aware of the astral/material oddity of the Jefferson Market triangle in 1977 but thought that the incident which I experienced there was part of a flow of "supernatural" incidents I was experiencing in context of ufo investigations.

I incorporated this slightly memorable incident – which is basically a mild version of a "man in black" experience – into a first draft of my book on "Sorcery and the UFO Experience" and then did not think about it frequently.

But in 1990 at a Thanksgiving party, I heard a tale of an odd mirage experienced at the intersection of Eighth Street and Sixth Avenue. I was interested in this anecdote because the location of my previous "man in black" experience – which involved a sinister voice speaking to me of personal details from a payphone which had been ringing as I passed – had occurred on a traffic island about one half block from the site of the mirage experience.

During the alleged mirage – which occurred in 1988 – the traffic along Sixth Avenue seemed to disappear to the eyes of several witnesses, then reappearing a few moments later.

I had a mildly skeptical reaction to this mirage anecdote. It happened that my new residence – after moving back into Manhattan from upstate New York – was about three blocks from the three way intersection at Eighth Street and Sixth Avenue. This was not planned. This was simply the fortuitous apartment which opened up for me amid the great NYC apartment renovation scramble of the 1990's.

There is a haircut business at Tenth Street and Sixth Avenue and one day I had gone in on the spur of the moment to get my hair cut. I had an odd experience when I looked into the mirror as my hair was being trimmed. I did not exactly see myself but saw the visage of a different person: a woman about ten years older than myself and with a world-weary face.

As this was happening, I ran a 'reality check' on myself. Were the overhead florescent lights making me look older? Was I actually tired and cynical that day? Etcetera. However, when I got up from the chair to walk to the front counter and pay the barber I spontaneously turned to the side and glimpsed myself in another mirror – wherein I saw a normal reflection.

Then as I approached the cash register it became apparent to me that one of the barbers was having trouble making the machine work. My barber stepped up to him and said: "Here, let me touch it. It sometimes starts to work when I touch it."

It did start to work when she touched it. So I paid for the haircut, tipped her and exited the shop without commenting on the apparition I had seen while she was working on my hair.

Since this shop is only two blocks from the intersection of

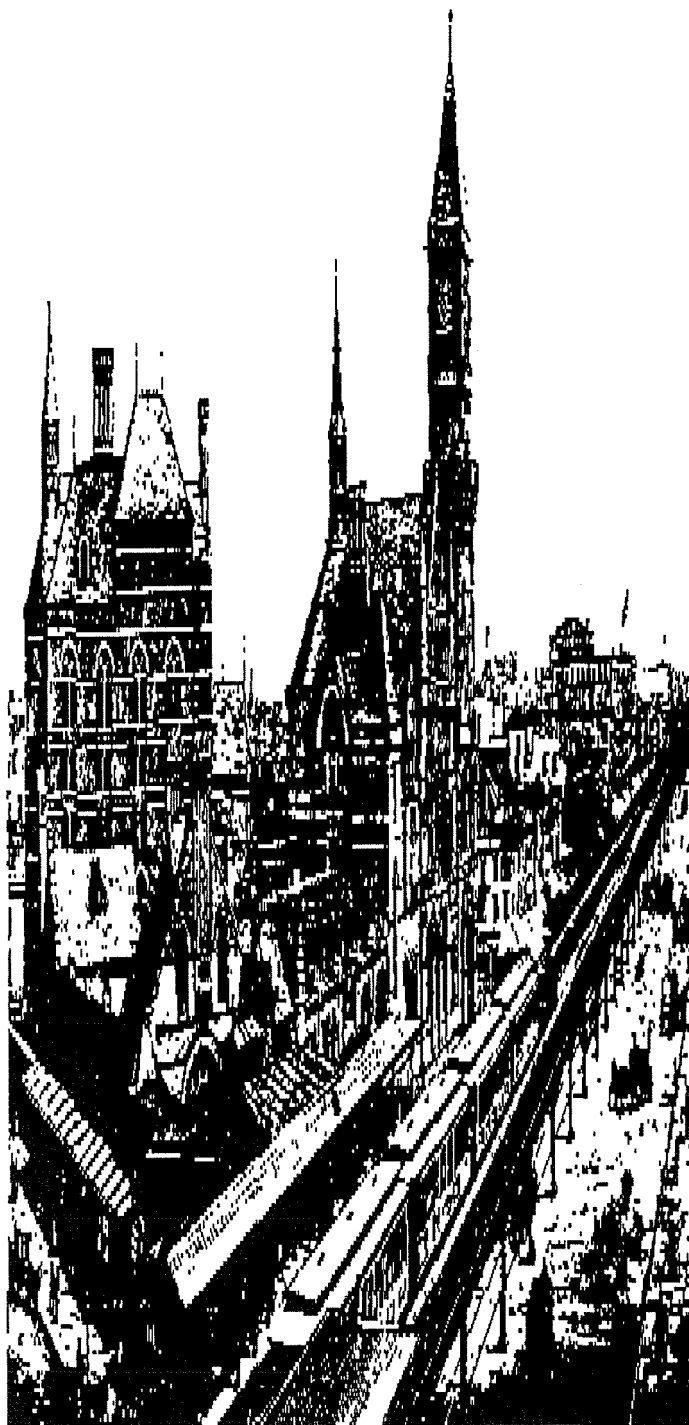

Eighth Street and Sixth Avenue where the other odd, marginally supernatural events had occurred, my interest in the area itself began to activate. I do not remember exactly when I began to assume that the Jefferson Market area was actually an approximately triangular "geoactive" zone and to study it as such. But it was shortly after the incident at the barber shop and a few other incidents in the area which involved oddly "significant" totals on cash registers.

I recalled also the words of the realtor who had negotiated the lease on my new apartment adjacent to the Jefferson Market area: "People looking for apartments in this area usually find exactly what they are looking for: I've noticed that."

It seems that in my simple quest for a convenient city residence I had blundered (or perhaps accurately dowsed myself) into a "wishing well" zone which facilitates astral/material manifestation.

It is an interesting fact that all buildings within the Jefferson Market triangle are commercial or public property locations and that residential dwellings (mainly occupied by out of towners seeking their fortune in Greenwich Village) are found only on the periphery of this approximately three block square area. Things seem to be "processed" here in the astral/material sense. An artist with a dream may actually sell a picture to a tourist with a similar dream who has come into the market area to attend a weekend street fair.

Deliberate mental magick is not actually so simple transactionally but the "dream for dream" example will give a handle on the materialization facility of the area — which is also useful for such brief, mentally-triggered events as reconciliations and the inception of business and marriage contracts. The key to positive use of such an area by an "aware" individual is the image of sales, planning and material shifts of destiny. But since the occult activation is astral/material, the aware individual should not remain within the area indefinitely or a great number of reconciliations and beginnings will accumulate without any long term continuation.

I found—for example—that toward the end of my three year residence in the area a number of "prizes" and "bargains" had begun to fill my small apartment. I had won travel clocks, radios and other such gew gaws and had found fantastic deals on TV's, silverware and jewelry. But since I am not a magpie I really had no basic use for all these trinkets which had been so easy for me to acquire on a casual whim.

On another level: I did manage to transact various contracts, sales and personal reconciliations which are positive, not entirely material and will stay with me as continuation when I do reside elsewhere.

Since the idea of an active magickal and/or geoactive zone within an urban environment may be a completely novel idea to people used to thinking of these areas as obscure locations in the mountains or at sea, I have fused diverse aspects of my study of the Jefferson Market area in a concise form which will help the reader to grasp the situation.

Once an area has been perceived as an astral/material "hot spot", one of the first questions which arises is: "Is there underground water?"

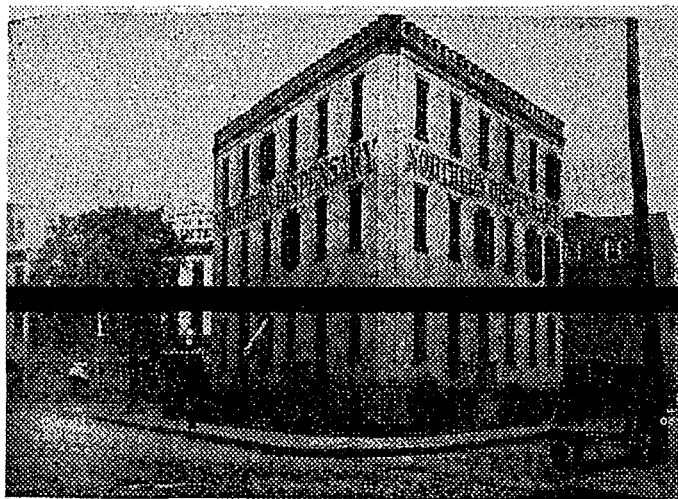

After research in the local library, which is conveniently located within the zone in question, I can verify that the land which is now the Jefferson Market area was once a marsh. In fact: the library itself was once a fire tower with waterworks attached beneath.

As I researched the history of this marsh area, I learned that a distinctive triangular building called the Northern Dispensary had once been the far northern marker of the small village at the tip of Manhattan Island. This building is maintained as a historical site and is located only one block from the address I occupied dupring my residence on Waverly Place at the edge of the Jefferson Market triangle area.

It seems that there must have been a "reason" for building a triangular hospital building just at the edge of a geoactive area. Perhaps the early residents of the island knew of the unusual astral activity in the marsh and were setting up a "marker" building to indicate the near northern edge of this area. We can never know for sure since many architects and masons have used geomancy in their planning without indicating overtly the actual occult reason for setting a building at a certain orientation.

It is an interesting fact that the famed writer on the supernatural Edgar Allen Poe once lived on West Third Street not far from the Jefferson Market area. In historical records, it is documented that he was once treated for a cold at the Northern Dispensary clinic.

Possibly Poe, whose long term residence in the city was on West Eighty-Fourth Street, had an "aware" reaction to the astral/material "hot spot" and moved uptown.

In January 1992, I "walked aware" around the perimeter of this zone and took color photographs. On one of the photos, taken at the intersection of Seventh Avenue and Fourth Street facing Northeast, an unusual aerial shape is seen. This looks like a cross between a large dark bird and a wind instrument such as a saxophone or tuba.

There is nothing evil or sinister about the unusual image on the photo. It is just inexplicably "there". I thought that it might be a plastic bag somehow distorted by an updraft. But when it is magnified, no mundane object appears, only the shape of the flying horn.

In October of 1990, during the first Halloween celebration I experienced while living adjacent to the Jefferson Market, an unusual thought occurred to me. I was returning from watching the annual Halloween parade on Sixth Avenue when I felt that I was in the presence of Cernunnos, the ancient horned god.

In the OCCIDENTAL MYTHOLOGY volume of his series entitled THE MASKS OF GOD, Joseph Campbell states that in the Irish epics Cernunnos is called the Dagda, from "dago devas", the "Good God."

But I did not have any idea of this complex reference as I returned in my red alchemical costume from the 1990 Halloween parade. I knew only that the name had come to mind and that I remembered he was a horned god. In fact: Cernunnos wears the antlers of a stag and not the goat's horns. In ancient statues and carvings he may carry on his arm a sack of abundance from which a river of grain proceeds.

But in the Irish epics he is also a kind of clown who figures in various tales involving his caldron from which "no company ever went unthankful". According to legend, his incredible stew both restored the dead and produced poetic inspiration.

Perhaps the flying horn on the photo taken in January 1992 is the horn of Cernunnos. If so, the Dagda of the Jefferson Market triangle has been kind to me. He has allowed me to see certain aspects of his existence but has also left his operative image incomplete. Who knows what might be at the bottom of the stewpot, under the layers of concrete and at the source of the springs which once fed the marshland?

There was a jail located just behind the old water tower which is now the Jefferson Market library and, of course, the fire alert which was rung from the tower was a warning of disaster, not an angelus. Cernunnos in the old Celtic folk tales is often represented as an old clown who can be tricked into eating and drinking entire carloads of cattle and mead and it is clear that some of the transient inmates of the West Village jail must also have met that description – even after the old jail became the women's house of detention.

Now the jail building has been destroyed and the area sports a community flower garden. Possibly this represents one of the bountiful transformations of old Cernunnos.

The shape in the "flying horn" photo also resembles a cornucopia. According to BULFINCH'S MYTHOLOGY, young Jupiter broke off one of the horns of a goat belonging to the daughters of King Melisseus of Crete, endowed it with magic powers and gave it to the women who had been his nursemaids.

The concept of this magic horn of plenty does seem to correlate with the "wishing well" quality of the area which may cause a great many bargains, deals and reconciliations to pile up within the chambers of the "aware" individual who decides to utilize the astral/material transfer capacities of this unique urban geoactive zone. But if the aware individual remains too long within this zone, s/he may end up at the bottom of a stewpot with the Dagda or meet the mature god Jupiter, who was a crafty shapechanger and had the power of thunder.

Indeed, the "flying horn" hovers in the sky much like a thunder cloud. Or is this odd shape really a flying horn? I see it as such because I am familiar with jazz music and cornucopias but

another person might see it as an unidentified "demonic" emblem surrounded by a red "aura." The reddish outline of the dark aerial cornucopia is quite visible when the shape is enlarged.

While living adjacent to the Jefferson Market geoactive zone, I did experience a "night hag" presence which occasionally woke me in the early hours of the morning. This entity either was earthbound due to a form of insanity caused by poverty and abandonment or was deliberately trying to instill in me a negative self-image. Perhaps it was the "night hag" which I saw in the barbershop mirror and which initially prodded my curiosity and caused me to deliberately investigate the area.

If so: she may have been an "aware" individual who became fascinated with the preternatural "cornucopia/casino" quality of the geoactive zone – only to find that an easy avalanche of bargains and reconciliations is not completely satisfying in the long term. A topological analogy to this situation is simply that junctions in the road are useful, a place to turn around, visit a mall, or switch directions – but a road of continual junctions is not useful for a long journey.

Thus: the triangular shape of the old Northern Dispensary clinic may have been both a symbol of healing and a warning that there was something unusual about the marshland located directly North of the original Village on the tip of Manhattan Island.

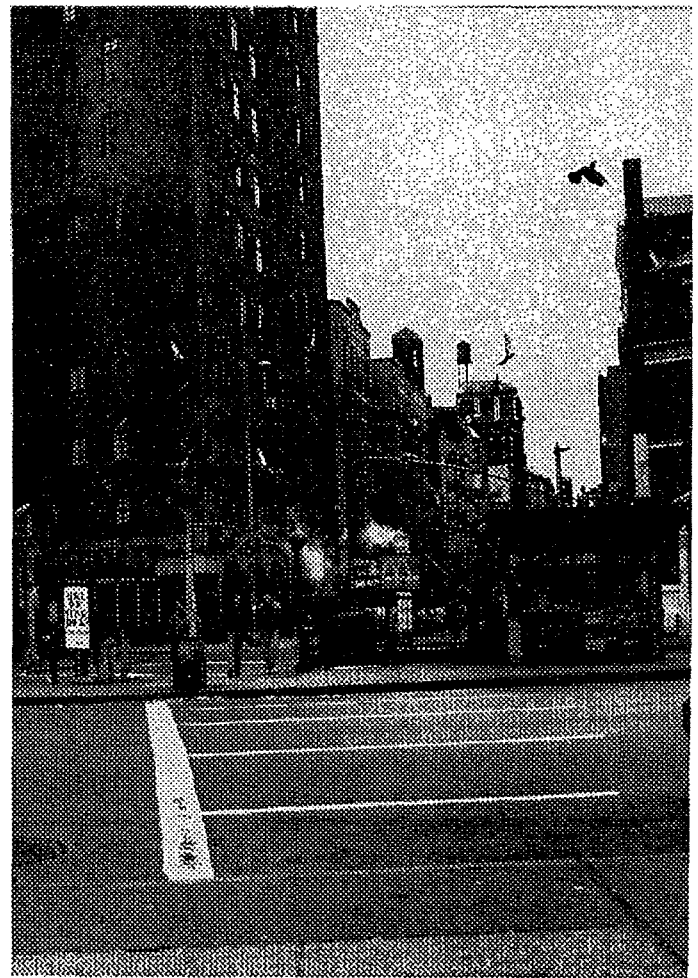

THE PAPER DOCTOR

A Vibrational Medicine Cabinet

by Don Gerrard

A book review by Peter A. Lindemann

Over the years, I have been exposed to a wide variety of radionic and vibrational healing systems. A number of these used symbols drawn on paper as the source of the vibrational remedy. Both Malcolm Rae and Christopher Hills did exceptional work in this field in the 1960's and 70's. Now, Don Gerrard has taken this tried and true method of transferring subtle vibrations and presented it in a way that makes it instantly usable by anyone.

First of all, The Paper Doctor represents a vast amount of work by the author. Ten years in the making, Mr. Gerrard and associates have created over 100 symbolic patterns that embody a wide variety of healing influences. To do this, he has drawn on his in-depth knowledge of radionics, homeopathy, flower essences, gem elixirs and other natural healing modalities. Each of the symbols presented in the book is new and original and has never appeared anywhere else. Each symbol has been tested to make sure that it works, and works well. Don's testing procedures have included hundreds of people over years of development. Symbols were chosen for the book only if they worked well for a high percentage of the test subjects. In preparing to write this review, I had a number of real first-aid situations arise where I tried the system out myself. Each time I could quickly feel the remedy having an effect and usually it was the effect I was looking for. If I had a little more familiarity with the system, I assume my results would improve.

The development and testing of the new patterns established an excellent foundation. Others have gotten this far in similar projects and stopped, but Don Gerrard was just warming up. The Paper Doctor is much more than a collection of useful vibrational patterns. It is a complete "how-to-manual" on the use of vibrational medicine in general and on the use of his system in particular. The book includes in-depth and detailed instructions on "how to use this book", "how it works" and "how to use the remedies." It tells you how to get started, how to choose a remedy, how to make the remedy, how to evaluate its effectiveness and what to do if you are having trouble. Each vibrational symbol given is accompanied by a detailed list of indications for that remedy with cross-referencing to other remedies that have similar or related actions. This cross-referencing feature is a wonderful benefit to the user. Beyond that, more information on "Special Indicators" as well as what to do in medical alert situations are also provided. Other helpful hints and useful tid-bits of information are included throughout the text.

With all of this attention to detail, the book could easily have been cumbersome, but the way the book is organized is the best thing about it. Everything is explained in simple and concise language and then illustrated to eliminate any possible misunderstanding. People who know nothing about vibrational healing methods can easily find their way through it and be effectively

using The Paper Doctor in a few hours.

At every opportunity, the author has paid close attention to the very kind of details the user might want or need to know. The style of writing is detailed but not long-winded or boring. The author's voice is friendly and helpful for the beginner while remaining informative and engaging for the advanced user. No matter how much or how little you know about vibrational healing,

if you are interested in the subject, this book should be added to your collection and used regularly.

In summary, with its easy table of contents, detailed index, illustrated explanations and in-depth internal cross-referencing, The Paper Doctor is no less than a masterpiece in the field of subtle vibrational healing. In this writer's view, it also establishes the high mark of achievement by which all other symbolic healing systems should be judged. It is, quite simply, a brilliant example of how to do something right! True to form, something this good could not long go without the notice of the Medical Gestapo. It is currently not available in bookstores because it has been outlawed in the State of Texas and the book wholesalers could not guarantee that future copies would not go to Texas if they continued to make it available through the normal channels. So, if you are interested in this highly recommended vibrational medicine cabinet, please contact: Don Gerrard, 729 Genter St. La Jolla, CA 92037 for availability in your area.

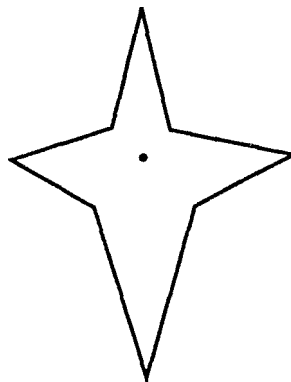

**Remedy for
Backache**

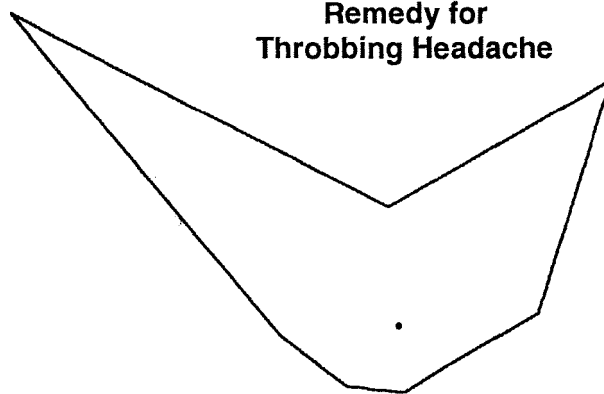

**Remedy for
Throbbing Headache**

2nd Hungarian Conference on Psychotronics — an Overview

This second conference was held last April in the historical setting of the Burg of Buda. Many participants convened from neighboring countries. They came with a wealth of results. The spectrum of topics ranged from spiritualist expositions to down-to-earth economical applications. Some of these ideas are already parts of success stories.

On the practical end, the Austrian based conference sponsor, Aquapol, Inc. has long been using psychotronic devices to dry water damaged buildings, inside and outside, Europe-wide. The need of doing any alteration in the structure of the water damaged building is totally eliminated. The device does not need any power, electrical or otherwise. The company says, they use tachyons from outer space to polarize water, causing its departure from the wall. Installation of the equipment leads to huge savings since the action takes a few months to completion. Another success story is the development at a Psychotronics Research Institute of Slovakia. They specialize, but not exclusively, in agricultural applications. Their main activity is balancing the biofield in areas of farming to yield better quality, healthier animals and plants. The director estimates the investment: profit ratio 1 to 30. This is probably due to simple, low cost devices and large animal populations. Basic research was highlighted by Kirlian photography of the human aura, showing significant differences between energetically rich and energetically deficient individuals. Some not so well publicized remarks on the late Pavlita's psychotronic generators revealed, that not only the magnetization curves of various materials can be affected by mind, but the direction as well, at will, as proved by precise measurement. Industrial application can be contemplated in areas where precisely this capability would be required.

Two aspects of architectural psychotronics were exposed during the Conference. The first, somewhat overlapping with spiritualism, was an investigation of biofields in and around Christian churches. In parallel with the human biofield, churches are said to possess a chakra structure depending on size and form. It is hypothesized the true function of a Christian church, as a biofield resonator, in case of proper dimensions and alignment to magnetic poles and the magnetic grid.

The second presentation was on considerations of new age ideas in the design of multifunctional buildings, also by Aquapol, Inc., with proper shape, materials and alignment with respect to geomagnetism. Such considerations have seldom been part of architecture design since some of these are religious "secrets".

Alternative medicine was represented by practitioners emphasizing the relationship of inner bioenergetic harmony with the bioenergetic content of foodstuff and geomagnetic pollution of the living area. It is necessary to note that alternative medicine is freely practiced in Hungary. Foreign experts are welcome to share experiences.

The greatest success of the demonstrations was the ceremony

of Agnihotra, an ancient method of healing fire. It is performed using a reverse copper pyramid with strict dimensions and proper materials burnt at sunset. At the proper time, the ceremony leader appeals to the Gods with the right words that can be easily learned, to purify the environment of the fire. During demonstrations, large amounts of bioenergy could be measured. This is certainly a strong candidate to rejuvenate the ailing environment caused by misuse.

The conference concluded that psychotronics has a bright future. Due to the number of presentations it was decided that specialist conferences will be held on medicine, architecture, agriculture and energy. The next conference is scheduled to take place on the special topic of free energy/anti-gravity. The emphasis will be on demonstrations of working devices whatever the underlying principle may be. A call for contributions is herewith announced from Europe and North America.

If you would like to have further information on the products, procedures and methods, including the companies/ institutes involved, please contact

G. Belovari, H.A.

Alkotás u.25.6.VII/53

H-1123 Budapest, Hungary

who can also take care of your contribution to the next conference. To ensure an early reply please enclose some IRC (International Reply Coupons) available from your local Post Office, depending on the amount of information you would like to receive.

TESLA'S EARTHQUAKE MACHINE

A new book, by Walter Baumgartner and Dale Pond, presents new technology based on SONIC VIBRATIONS produced by a simple device - The Tesla Oscillator. In the oscillator described, a RESONANCE EFFECT can be observed with accumulative effect - vibrations would destroy the apparatus if uncontrolled. Experimentation done by Tesla and Walter Baumgartner on the basic principles are taken and expanded. Clarifications are added from Keely's work on principles of vibration and other orthodox sources.

Perfect bound, 160 pg., many drawings, illustrations, and shop drawings for building your own oscillator. Send \$75.00 plus \$4.00 shipping & handling to:

Delta Spectrum Research, Inc.

P.O. Box 5307, Bella Vista, Arkansas 72714

501-855-3946

The Lakhovsky MWO: Back To Square One

Peter A. Lindemann

Sometimes the most obvious things take the longest. I am reminded of all the wild hype that surrounded Tesla's work back in the 1980's and the crazy new theories that were put forth on how his wireless power system supposedly operated. Smelling a rubber fish in the pan, BSRF railed against the madness and eventually released a video presentation of Tesla's wireless power system in action. Remarkably, all it took was the genius of Eric Dollard and *going back to Tesla's patent*. The model built from the patent performed as claimed. No new theories or explanations were needed. This video, **Tesla's Longitudinal Electricity** is proof enough that going back to the original design is the best place to start when trying to understand or *duplicate* someone's work.

So, the question is, has anyone ever tried to *duplicate* Lakhovsky's MWO as it is described in his patent? After finally asking myself the right question, I carefully read through **The Lakhovsky Multiple Wave Oscillator Handbook** for the answer. What I found is quite interesting. Every single MWO schematic printed in the book, except for Lakhovsky's patent diagram, is a model of or a variation on one of Tesla's electro-therapeutic devices! It seems that for the last 30 years, people have just been putting Lakhovsky's famous multi-ringed antenna at the end of a Tesla circuit and thinking that they had the real thing. All of these units, variations on a circuit presented by Bob Beck in 1963, spark profusely between the rings of the antenna. Bob has repeatedly told experimenters to build their MWOs with more and more power so that they will produce increasing amounts of sparking on the antenna. Our files contain letters from people who report excellent results from these devices. The accolades, however, have not been universal. The big problem with this style of MWO is that people who are sensitive to subtle energy, like myself, can't stand to be in the same room with one of them while they are operating because they are so irritating. Something was not right in all of this, and I wanted to figure it out.

To illustrate the problem, I have included four schematic diagrams here for reference. Figure 1 is the schematic of Lakhovsky's MWO taken from his patent. Figure 2 is a schematic taken from an article by Tesla on his electro-therapeutic experiments. Figure 3 is the schematic for a "high power MWO" taken from page 77 of the **MWO Handbook**, and

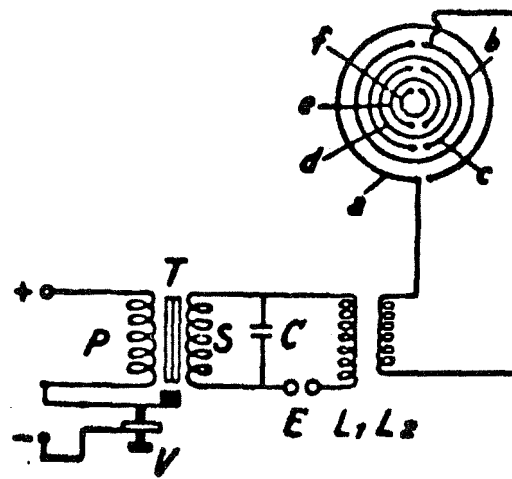

Figure 1

Figure 4 is the schematic of the Bob Beck/Klark Kent MWO (simplified). After

studying these circuits for a while, I realized that there were a number of basic differences. Lakhovsky had placed the spark-gap and the capacitor in a different relationship in the middle section of the circuit than Tesla and the others. Could this be important? Lakhovsky had also stepped the voltage down in the final stage of the circuit where Tesla and the others all stepped the voltage way up. Was this significant? What was Lakhovsky trying to do that was different than what Tesla was trying to do?

There were some other things that also puzzled me. Both Lakhovsky and Tesla had well developed subtle sensitivities. Lakhovsky used a pendulum to help him in his design work and Tesla's expanded sensory abilities are mentioned throughout his writings and the writings of his biographers. Because of this, I assume that both of their electro-therapeutic devices were totally benign to be near, even to very sensitive people, like themselves. I assume this because nothing leaves my laboratory that I don't personally like. Experiments I have run strongly suggest that all of the effects that cause sensitive people to be irritated by these units (Beck/Kent style MWO) come from the sparking between the rings of the antenna. This brings up the question of whether or not the MWO antenna is supposed to spark. Tesla is very clear in his writing that his units worked much better when all electrical discharges from the terminals were suppressed. At one point, he even describes using 2 inches of wax to cover the terminals (antennas). Likewise, Lakhovsky never mentions sparking discharges between the rings of his antennas. Some photos show a brush or corona discharge off the

outermost ring of his MWO antennas, but no mention is made of this being the normal therapeutic operating mode. Also, no photo of Lakhovsky's MWOs ever show arcing *between* the rings. In light of this, I am convinced that both Tesla and Lakhovsky designed their devices to eliminate this behavior. I strongly believe that Lakhovsky's real MWO does not create sparking discharges

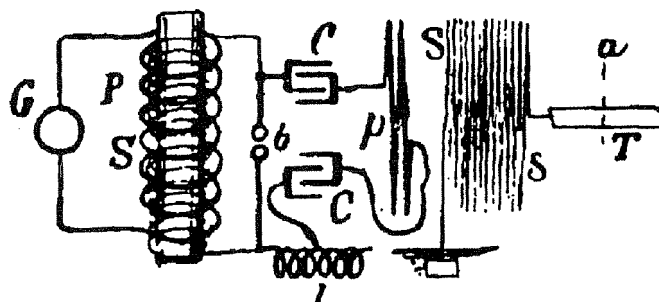

Figure 2

A HIGH-POWER MULTI-WAVE OSCILLATOR

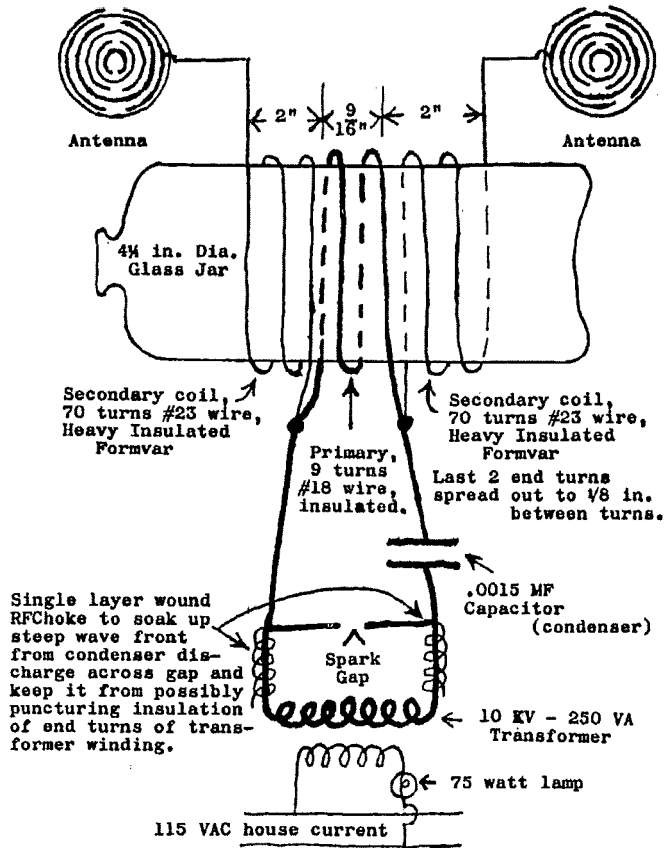

Figure 3

between the rings of the antenna.

Having resolved these issues to my own satisfaction, I decided that the only way to find out the rest of the facts was to actually build a circuit that behaved like the circuit in Lakhovsky's patent. To do this I had to decide what components to use, as no parts values are given in the patent. Even if they were, these parts would not be available today. What to do? In Figure 1, Lakhovsky begins by powering the primary coil of a transformer on DC (direct current) that is rapidly interrupted by a device he calls a "trembler" (V in Figure 1). The purpose and function of this trembler is to provide a sequence of DC pulses to the primary of the transformer by mechanically making and breaking the DC power feed to the primary winding. I decided that one of Klark Kent's 12 VDC power supplies driving the primary of an automobile ignition coil interrupted by a solid-state transistor circuit was a suitable modern substitute. It performed the same functions that Lakhovsky specifies in the patent. I 'acquired' one of Klark Kent's MWO units from the Borderland collection and went to work.

Besides the first stage power supply driving the primary of the coil, everything else in the Klark Kent MWO was essentially a Tesla circuit, so I took it apart. I removed the high voltage output coil completely and rewired the capacitors and spark-gap so that they were in the right place in the circuit according to Lakhovsky. The L1 and L2 output coils I decided to build, since

no suitable replacements were available. Without any clear directions from the patent about the proper dimensions for these coils, I actually had to *think* about it. Small, tightly wound coils usually block high frequency signals and, for this reason, are sometimes called "chokes". Obviously, these coils were not supposed to be extremely small because passing a wide spectrum of high frequency currents was their purpose. By contrast, one of Tesla's designs specifies a 2 foot diameter coil set in this location in the output. But photos of Lakhovsky's MWOs clearly show no coils that large. I decided to wind two coils about 2 inches in diameter to begin my experiments. L1, the primary, I wound with 7 turns of bare #18 single strand copper wire. The turns are about 1/3 of an inch apart and stand free in the open air with no dielectric material or coil form near-by. L2, the secondary, is only 5 turns of similar wire and dimension. The two coils are placed end to end about an inch apart. The ends of L2 are connected to rings 1 and 2 of the printed circuit board MWO antenna developed by Eric Dollard and BSRF, as illustrated in Lakhovsky's patent. L1 is connected to the capacitor and the spark-gap.

Awesome! I was finally in possession of a reasonable facsimile of a *real* Lakhovsky MWO (Figure 5). [I decided to retain the high voltage diode from the Klark Kent circuit to help protect the ignition coil from the discharge of the capacitor. This was the only deviation from the Lakhovsky circuit that I made, and I do not believe it negatively affects the quality of the output since it is not in the capacitor discharge loop.] In trembling anticipation, (not really) I turned the unit on. Besides the irritating noise of the spark-gap, the energy effect coming from the antenna was very gentle and very penetrating. Within 15 minutes, a noticeable relaxation effect was evident and a gentle "buzz" feeling was present throughout my body. This experiment, long overdue, begins to confirm my many speculations about the nature of Lakhovsky's MWO and opens up a clear, new direction for future research.

The two design changes that this article addresses are: 1) the location of the spark-gap in the circuit and 2) the method of driving the antenna. In Tesla's circuits and the Bob Beck/Klark Kent style of MWOs, the spark-gap is driven by the *inductive collapse* of the secondary coil and the output primary coil is capacitively coupled to this source of oscillations. In Lakhovsky's circuit, the inductive collapse of the secondary coil charges the capacitor and the *capacitor discharge* drives the spark-gap directly through the primary of the output coil. This difference has never been discussed before and I believe it to be important. A

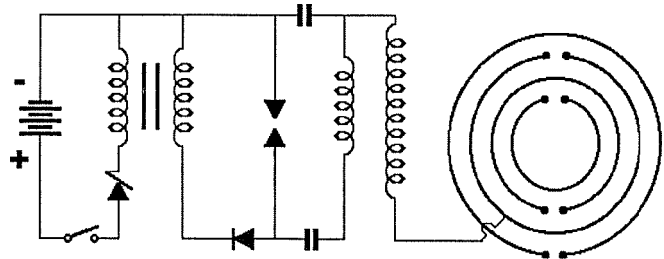

Figure 4

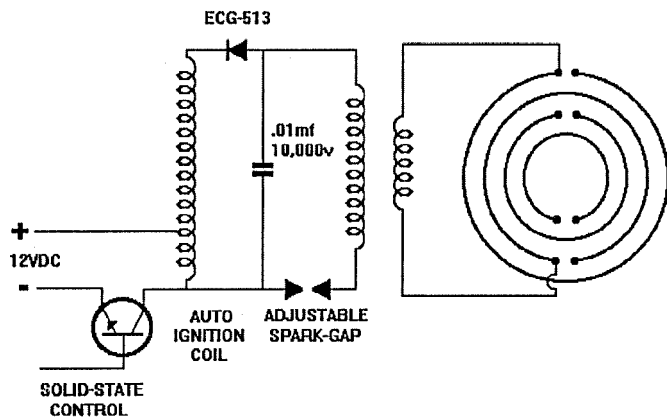

Figure 5

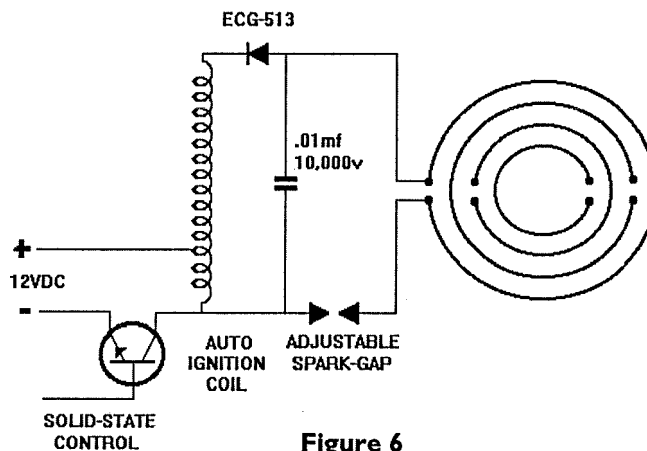

Figure 6

capacitor discharge creates a very different kind of “spark” than an inductive collapse. (Anyone not understanding this should watch the first 20 minutes of the BSRF video **Free Energy Research**. In it, Eric Dollard demonstrates both inductive and capacitive arcs and discusses the differences between them.) The Beck/Kent style of MWO uses the circuit primarily as a source of high voltage to produce arcing between the rings of the antenna. The various lengths of sparks at the antenna become the source of the wide spectrum of frequencies produced by the device. While this method may produce the required wide band of emissions, it was not the method Lakhovsky was working on. The patent is clear on this point, Lakhovsky envisioned the capacitor discharge as the source of his wide spectrum of frequencies and the multi-ringed antenna as a resonator system to draw out even more and higher harmonics by induction. As usual, the simple creation of multiple frequencies is not enough. The subtle nature of these frequencies and how they are created is also important.

Many experiments need to be tried on all of the possible methods of driving the antenna that are covered by the patent. Beyond that, the patent describes using only one antenna, whereas all of the photos of Lakhovsky’s MWOs show him using two antennas. The exact antenna hook-up is still unknown. I have now driven the antenna both electro-statically, as specified in the patent (Figure 5), and electro-magnetically by eliminating

L1 & L2 and directly connecting the outer ring of the antenna in the place of L1 (Figure 6). The effects subjectively seem stronger in the direct connection mode, but both are gentle and penetrating. I have also driven two phi-ratio spiral antennas in the electro-static mode facing each other, each spiral connected at its center to one end of L2 (Figure 7). The effects in the space between the two antennas are the most powerful I have seen yet. While use of these golden section spirals is a deviation from Lakhovsky’s designs, the configuration of using two antennas to set up an area of high frequency electrostatic oscillations between them was his intent, it seems. The effect in the area between the antennas is quite strong and lends credence to the electro-static mode of operation. Tesla also experimented with this method of driving the antennas which he called terminals (t) as shown in Figure 8. He used large copper plates for these terminals, and as such, did not expect them to augment the total frequency response of the system as Lakhovsky did with his multi-ringed antennas. My experiments suggest that when using one antenna, the electro-magnetic hook-up is the strongest, as in Lakhovsky’s RCO circuits. When using two antennas, the electro-static hook-up is the strongest, as in Lakhovsky’s MWO circuits.

In future articles, I plan to address the construction of a real Lakhovsky MWO antenna made from copper tubes suspended on silk threads as specified in the patent. I believe that the copper rings, unencumbered by the proximity of any dielectric material, will be able to ‘ring’ freely up into the very high harmonics Lakhovsky envisioned. This could be the final ‘improvement’ necessary to get us all the way back to where Lakhovsky was in 1931. The design for the real MWO may have been with us all along. Sometimes the most obvious things take the longest.

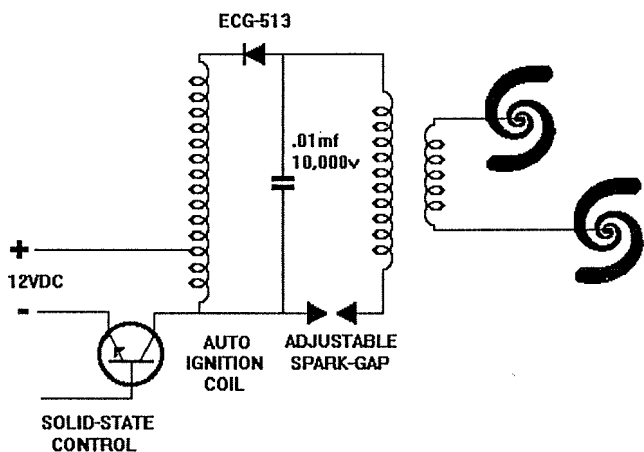

Figure 7

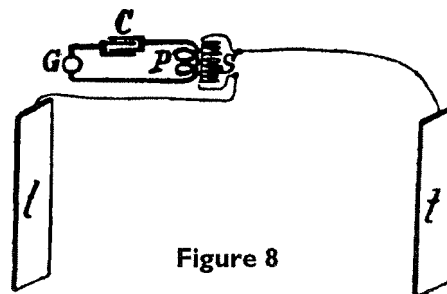
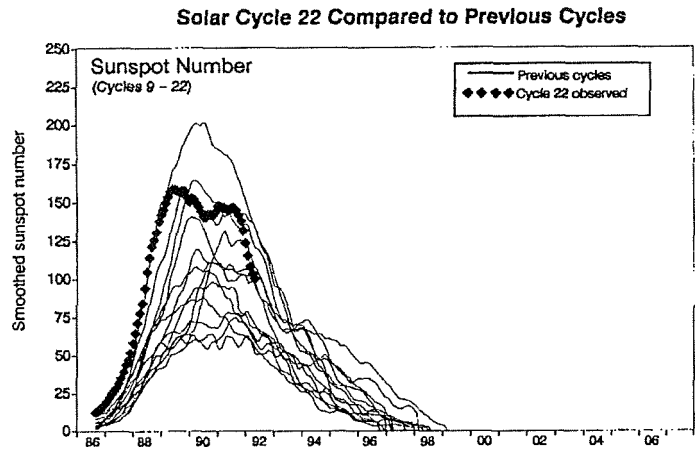

Figure 8

NEWS 'N VIEWS

FROM THE *BORDERLAND*

The drama of Solar Cycle 22 is waning. As you can see from this graph, the number and intensity of sunspots is diminishing rapidly after the spectacular flares of 89-91.



LETTERS

We have been thoroughly inundated with letters, requests for information, news, magazines, papers, you name it, it turns up on the Borderlands desk. With end of year madness, coinciding with a tremendous response to our 93 catalog mailing, storms, snow and flooding, federal slave forms to fill, and a small but cheerful staff to handle it all, we just haven't had time to sift through everything. But your letters haven't been forgotten and will appear in the next issue of Borderlands. So keep sending your news 'n views... it's all appreciated!

RECEIVED

A listing of books, video and audio tapes and other assorted materials received here at Borderlands. Longer reviews of selected materials may appear in future editions. Members who would like to do reviews may contact BSRF

* **PROPHECY: A HISTORY OF THE FUTURE** by Möbius Rex, Published by Rex Research, Box 19250, Jean NE 89019. 340pp, spiralbound, \$16.66 postpaid (USA), \$25.00 (overseas). The intent of author Rex is to help humanity "to know the signs of the times and to recognize the shadows that great events cast before them." Here is a

fascinating juxtaposition of prophecies to satisfy the most ardent apocalypticist. From old testament prophets to mediaeval soothsayers, from forgotten sybils to Native American shamans, space brothers and proponents of earth changes, Rex has collected a wide selection of original prophetic source materials.

* **A MODEL OF SUPERFLUID PHYSICAL VACUUM** by L. B. Boldyreva and N. B. Sotina. This curious booklet of formulae with an explanation written in both English and Russian was sent by Borderlander Constantin Ivanenko from St Petersburg, Russia.

* **HEALTHY AT LAST: Solutions to Chronic Ill Health, Allergies and Environmental Illness** by Cynthia Clinkscales. Available from bookstores or by sending \$11.95 to CECOM Publishing, Suite 43, Homer AK 99603. A welcome addition to natural and alternative methods of treating chronic disease. Topics include food allergies, candida, mercury dental fillings, homeopathy, chelation and more.

* **UFOS AND THE NEW WORLD ORDER: A Hypothesis Concerning the Political Implications of UFO Information** by Michael Lindemann. 36pp, \$6.95 plus \$1 postage from the publisher: The 2020 Group Visitors Investigation Project, 3463 State Street #264, Santa Barbara CA 93105. Also **ONE ON ONE**

ON UFOS: *Candid Conversations among the World's Top Ufologists* — Michael Lindemann interviews Colin Andrews on the Crop Circle Phenomenon, a video from Lightworks, P.O. Box 661593, Los Angeles CA 90066. \$29.95

- * **NATIONAL SIGHTING YEARBOOK 1991:** *Data on 1221 UFO Sightings from 1986-1991* by P. Ferrughelli, National Sighting Research Center, 60 Allen Drive, Wayne NJ 07470. Available for \$9.00 plus \$1.00 shipping (data disks in various formats also available). This is a yearly analysis and summary of anomalous sightings in the U.S. for info-hungry UFO investigators and researchers.
- * **IN SEARCH OF BENCHMARKS** by Craig D. Hanks, P.O. Box 2123, Bellingham WA 98227. "This material is an expansion of several short essays, wherein concepts such as labor, money, debt, rights, and others are discussed."
- * **HEALING ON THE EDGE OF NOW:** *A Practical Guide for the Use of Psychoneuroimmunology*. An inner guide to healing with practical exercises included, by Carl Brahe, SunShine Press Publications, PO Box 333, Hygiene, CO 80533. \$11.95.
- * **OF SOUND, MIND AND BODY** - a video exploring the myriad ways in which music, sound and vibration influence every aspect of our being. Featuring a well-known host of New Age presenters and musicians. Distributed by MACROmedia, PO Box 279, Epping NH 03042.
- * **DEEP DELTA** *Brain Hemisphere Harmonic Healing* audio cassette tape by Enid Lopez, who believes in "better and healthier living through electronics." Send a long SASE for free catalog to Tranquil Technology Music, PO Box 20463, Oakland CA 94620.
- * **IN QUEST OF ABRAXAS** by Anthony Whittington, limited edition by Omega-Point Publishing. Regular edition to be published this year. The Bibliography alone contains one of the most extensive reference lists of occult titles around.
- * **SECRETS OF BONSAI MINIATURE TREES:** *Their Care and Maintenance* by Charles Harnett, a former science writer now bonsai specialist who studied the art of the miniature under Japanese masters. Published by Bonsai East, PO Box 1097, Pigeon Forge TN 37868-1097.
- * **THE DICTIONARY OF MIND AND SPIRIT**, over 500 entries from Abraxas to Zen. Compiled by Donald Watson, Avon Books, 1350 Avenue of the Americas, New York NY 10019.
- * **CHASE THE DEVIL:** *Religious Music of the Appalachians*. A video from Beats of the Heart series, Shanachie Records, by English film-maker Jeremy Marre, capturing the exuberant preaching and music, the 'devil's work' of isolated mountain culture in the Southern Appalachians.

NEWS From The Borderlands

A POINT FOR GEOCENTRISM!

"W. G. Tift, an astronomer at the University of Arizona, has maintained for some two decades that the redshifts of the galaxies do not fall on a smooth curve as one would expect. Instead, Tift asserts, redshifts are bunched at intervals of 72 kilometers/second and at one-half and one-third that value. Mainstream astronomers insist that redshifts be interpreted as Doppler shifts due to the expanding universe. Quantized redshifts just don't fit into this view of the cosmos, for they imply concentric shells of galaxies expanding away from a central point — earth!

"Even though more recent redshift data have supported the notion of quantized redshifts, cosmologists find them indigestible, even pathogenic. But replication and non-replication are the essence of science so B. Guthrie and W. M. Napier at the Royal Observatory at Edinburgh, undertook another study. They selected 89 nearby spiral galaxies that had not been incorporated in any of the previous surveys. These galaxies had very accurately measured redshifts and were distributed all over the celestial sphere.

" "As expected, the galaxies' redshifts showed a smooth distribution. Clearly, no quantization was being introduced by the radio telescopes or the data reduction process. But after Guthrie and Napier corrected each redshift to account for the Earth's motion around the center of the Milky Way — a different correction for each location in the sky — out popped a periodicity of 37 km/sec, close to one of Tift's values. It was so strong that the chance of it being a statistical fluke was less than 1 in 3,000." (Anonymous; *Quantized Redshifts: What's going on Here?* Sky and Telescope, 84:128, 1992)"

Quoted from Science Frontiers, No. 84, Nov-Dec 1992, published by The Sourcebook Project, P.O. Box 107, Glen Arm, MD 21057

SORRY, NO DOOMSDAY TODAY...

SEOUL: A controversial doomsday sect has taken out a newspaper advertisement apologising for getting the wrong date for the Day of Judgement.

Ha Jae-Ho, leader of the Daverra Mission, on October 13 apologised to the South Korean people after Jesus Christ failed to appear at midnight on October 9 as the mission had predicted. "We sincerely apologise for troubling churches and society as Christ did not come on the date when we believed he would," said Ha.

In a related development, prosecutors formally indicted Lee Jang-Rim, a doomsday preacher. Lee, 46, was charged with swindling the equivalent of US\$4 million from his followers over the past four years, and illegally hoarding \$22,700 at his home.

South China Morning Post Weekly, October 16-22, 1992



STRANGE MAGAZINE

FRINGE SCIENTISTS

Wilhelm Reich
Nikola Tesla
Jack Parsons
Jacques Bergler

AERIAL ANOMALIES

UFO Occupants
Falls from the Sky
Ancient Astronauts
Cargo Cults

FORTEANA

Cryptozoology
Underground Mysteries
Kirlian Photography
Time Slips

INCREDIBLE ODDITIES

The Crystal Skulls
The Vinland Map
Archaeoanomalies
Crop Circles

WEIRD SCIENCE

Death Rays
Free Energy
Electrotherapy
Plasma Effects

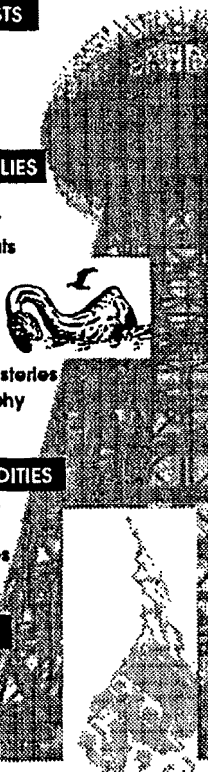

For five years STRANGE MAGAZINE has been bringing its readers an open-minded look at the mysterious world of Strange Phenomena. Each bi-annual 64-page issue contains fascinating first person strange encounters, in-depth investigations, documented reports, and fascinating articles by top-notch investigators of the unexplained including John A. Keel, Loren Coleman, Mark Chorvinsky, Jerome Clark, & Vincent H. Gaddis.

Send check or money order to:
STRANGE MAGAZINE:

PO Box 2246, Rockville, MD 20847

4 Issue subscription—\$17.95 (\$22.95 Foreign)
 Sample Issue \$5.95

Please charge my: VISA Mastercard exp. date

NAME _____ card number

ADDRESS _____

CITY _____ STATE _____ ZIP _____

TO BOLDLY GO, they demonstrate four of their five "findings" within Saturn's rings with PUSHES in one way or another. Their fifth "finding", in my opinion, is explained in a very confusing way. NOVA's 5 "findings" are shown in my tape. I also observed 3 other "findings" in Saturn's rings. All of these 8 "findings" are demonstrated in my tape with my models that operate under their own self-contained "repelling energies" supporting my push-gravity theory. NOVA demonstrates these 5 "findings" in animation, WHY??? NOVA never mentions Newton's pull-gravity law, WHY??? I received orders for my tape during JUNE 1992 from Alaska, Canada, Mexico, California, Nevada, Arizona, Colorado, Texas, Oklahoma, Missouri, Kansas and Arkansas. I'm hoping that you will order this tape, too, so you can give PUSH-GRAVITY the exposure it deserves. If you have already, then THANKS. These tapes would make an ideal birthday present, etc., for someone you know that has an interest in spacescience. My tape is only a \$10 donation, which includes handling and postage. I can mail it to you or to a person of your choice with a card enclosed stating it is a GIFT from you. **These tapes can be obtained from W. C. WRIGHT, 732 OHIO ST., FAIRFIELD, CA 94533, (707) 429-0598.**

EXPLORE!

NEW DIMENSIONS

Formerly *raum & zeit*, the only independent professional journal in the German and English speaking countries which deals with the fields of medicine and physics. One of the numerous goals of *EXPLORE!* is to bring the orthodox and unorthodox worlds together for the benefit of all.

Subscribe now to a quality journal presenting the latest research into shifting paradigms... a wonderful gift idea!

Call today or send to: *EXPLORE!*, P.O. Box 1508, Mount Vernon, WA 98273
206-424-6034 · Fax 206-424-6029 · 1-800-845-7866 (orders only)
One year subscription \$59.00 (USA) \$75.00 (Foreign Surface)
\$100.00 (Foreign Air) MasterCard or Visa

Vortexian Mechanics Implosion Dynamics Living Water Sciences

Workshop & Seminar with William Baumgartner, March 5, 6, 7, 1993
Hosted by Steward Ship Community

c/o Dave Lynch
5569 N. County Rd #29
Loveland CO 80538

\$295.00 includes full board and room. Excellent location and facilities!
\$100.00 deposit. Not refundable after March 1, 1993.
Workshop literature sent upon receipt of deposit.
For more information and details please call:

Bruce Mace
(303) 925-7345 or
(719) 746-2412

SEE YOU THERE DON'T MISS IT

PUSH GRAVITY VIDEO AVAILABLE !!

My 23 minute "high grade" VHS video tape, PUSH-GRAVITY PART #24, has been receiving, as they say in Hollywood: "RAVE REVIEWS." In the NOVA presentation,

THE VRIL COMPENDIUM

Author and researcher Gerry Vassilatos has spent several years scouring Victorian scientific archives in search of the arcane, the anomalous and the amazing. The fruit of these searches is the release of a singular work of astounding depth and immense power...**THE VRIL COMPENDIUM**. This project is an ongoing major work which is to be published in successive complete volumes. The chief academic value of the **VRIL COMPENDIUM** includes the fact that its documents, photographs, articles and extracts are taken, not only from a wealth of Victorian sources, but from legally weighty ones as well, such as the U.S. Patent Register. Each volume is a treasurehouse of patent documents in whole form. Volumes with prices will be published January 31, 1993.

VRIL COMPENDIUM I WHITE RAY CONDUCTORS

An astounding assortment of arcane designs and remarkable inventions is presented in our first volume. Aerial batteries were designs which made practical use of the energies which celestial currents and rays brought to earth. Patents of Ward, Vion, Palenscar and others offer the reader a rare glimpse into the workings of **VRIL** from aerial sources. Lightning rod patents fill the second section of the volume. Earth currents and earth resonance are discussed extensively in this volume.

231 pages, B0223 \$36.95

VRIL COMPENDIUM II VRIL TELEGRAPHY

A history of the telegraph concept and systems precedes the patent section. Telegraphy began with a truly radionic basis. Early telegraphic systems utilized the strange and mysterious correspondences acquired between specially treated magnetic needles and sympathetic pendulums (properly grounded and oriented). **VRIL** maps show that the telegraph system was literally generated along **VRIL** paths as railroad personnel followed their own intuitions while laying track. Signals versus meanings are discussed in articles on communications. The **VRIL** function and potential of telegraph poles, insulating materials, cables, and primary telegraph componentry is detailed.

233 pages, B0224 \$36.95

VRIL COMPENDIUM III VRIL LINKAGE

The manner in which **VRIL** radiance has been apprehended through "aquavideo", photographs, and photochemical means is thoroughly documented here in remarkable depth. Introducing telegraphic patents which made direct use of ancient geomantic means for communicating intent: non-electric pendulum telegraph systems, and **VRIL** impression recording systems. How carbon potentiometers were utilized in order to "entune the ground" is presented through several score pages of pertinent patents. The use of potentiometers and rheostats in order to "balance the ground and the system" was a commonplace item to the telegraphic operators of old - they were entuning the earth-permeating power of **VRIL** directly by these means! Each ground required its own tuning rate. Realizing that signal without meaning is not communications is a key feature of discussion. The use of strange capacitors and condenser systems allowed the guiding of **VRIL** threads through telephone systems and into their natural deep channels far below the surface is told through the many patents.

B0225 (in progress)

VRIL COMPENDIUM IV VRIL ARCHEFORMS

A remarkable assortment of earth battery patents. A primer course in **VRIL** genesis of metal lodes and placer deposits is found here. Diagrams and photographs adorn the text. **VRIL** structures and virtual architectural forms are discussed. How ancient architecture managed to accumulate, intercept, and modulate **VRIL** was only the faltering first steps of a science which has yet to reach its perfection. The use of radionic tuners (made to entune **VRIL** and raise virtual structures) is discussed throughout this section of photographs and illustrations. How it is possible to comprehend the non-material architecture of experience-altering spatial forms is a must reading source for all scholars of **VRIL** science. Subterranean Halls offers various patents which chronicle the progressive move away from aerial telegraphic structures toward buried tunnels and telluric **VRIL**. These patents record the manufacture and use of tunnels and cables. These are remarkable as **VRIL** accumulators, directors, and modifiers. The cables and their tunnels are remarkable geometries by which magneto-electric signals were enhanced. In all...a most thorough and comprehensive account of **VRIL** subterranean guides and interceptors.

303 pages, B0226 \$48.95

VRIL COMPENDIUM 5 VRIL CONNECTION

The discovery of nerve-induction telephony by Antonio Meucci in 1849 marked the true birth of telephony. Meucci's unheralded genius marks the victorious biography of a modern savant. Antonio Meucci's initial great discoveries were followed by the independent developments and designs of Elisha Gray. In these documents, patents, and articles we read of developments whereby deaf persons could hear directly through the nerveworks of the body. In these early attempts to approach true empathic transmission we see the basis of systems which Tesla would later advance to a wary scientific public. Meucci's pioneering works in telephony, wireless telephony, unpowered telephony, intercontinental wireless, distant electro-ranging, and underwater wireless were made well before the start of the American Civil War!

177 pages, B0227 \$28.95

VRIL COMPENDIUM VI VRIL TELEPHONY

A treasurehouse of patents! A presentation of nearly every pertinent **VRIL** transducer of which telephony was comprised. How the human aura and its **VRIL** threads dendritically merge with the natural **VRIL** is the central theme here. Every kind of transducer is shown: liquid, organic, magnetic, and other species. Presents systems which intensified the **VRIL** content of telephone lines with no need for electrical power! Patents by whose means "static" was to be neutralized describe how the **VRIL** portion of telephonic communications were intensified and modulated. Presents the secrets whereby telephonic systems patterned themselves along **VRIL** trails: distribution systems and local exchange systems.

B0228 (in progress)

VRIL COMPENDIUM VII VRIL DENDRITIC GROUND SYSTEMS

A presentation on the three earliest *unknown* wireless researchers: Mahlon Loomis, Nathan Stubblefield, and Dr. Amos Dolbear. This marvelous volume chronicles the discovery of natural **VRIL** power in the earth ... usable power for communications of signal, word, and intent. Loomis developed his wireless system in 1860; using elevated metallic terminals in the absence of battery power. He sent powerful signals across miles of mountainous space. Stubblefield developed means for drawing **VRIL** from the ground directly and "transmitting vocal messages with clarity" through the ground. Proof that Nathan had indeed found the means by which "sound, light, motive power, and heat...could be taken directly from the ground". Dr. Dolbear is presented through his wireless design patent. His use of elevated capacitors is intriguing and tantalizing ... demanding further investigation.

207 pages, B0229 \$33.95

Postage & Handling - add \$2.75/ first item, plus \$1 each additional item.

California residents add 7¼% Sales Tax. Visa/Mastercard orders call (707) 986-7211

AMAZING TITLES FROM BORDERLANDS

The Cosmic Pulse of Life, Trevor James Con-
stable. #B0095 ... \$24.95

My Search For Radionic Truths, R. Murray
Denning. #B0090 ... \$9.95

Metal Power – The Soul Life of the Planets, Alison
Davidson, #B0125 ... \$8.95

**Course on the Relationship of Astronomy
to the Diverse Natural Sciences**, Rudolf Steiner.
#B0106 ... \$20.00

Biological Anomalies: Humans I, William R.
Corliss. #B0222 ... \$19.95

**Spiritual Scientific Medicine and the Heal-
ing Arts of Tomorrow**, Karl Maret, M.D. video.
#V0019 ... \$19.95

Bipolar Theory Of Living Processes, George
W. Crile. #B0008 ... \$34.95

**The Phenomena Of Life – A Radio-Electric
Interpretation**, George W. Crile. #B0062 ... \$29.95

**Psychical Physics – A Scientific Analysis of Dows-
ing, Radiesthesia and Kindred Divining Phenomena**, S.
W. Tromp. #B0097 ... \$39.95

**The Lakhovsky Multiple Wave Oscillator
Handbook**, by Tom Brown. #B0092 ... \$17.95

**The Eye of Revelation – The Original Five Rites
of Rejuvenation**, Peter Kelder. #B0093... \$3.95

The Five Rites of Rejuvenation, video.
#V0034... \$29.95

Awaken Healing Energy Through The Tao,
Mantak Chia. #B0182 ... \$10.95

**Taoist Secrets of Love - Cultivating Male Sexual
Energy**, Mantak Chia & Michael Winn. #B0189...
\$14.95

**Healing Love Through the Tao - Cultivating
Female Sexual Energy**, Mantak & Maneewan Chia.
#B0187 ... \$14.95

Chi Nei Tsang - Internal Organ Chi Massage, Mantak
& Maneewan Chia. #B0184 ... \$16.95

**Taoist Ways to Transform Stress Into Vi-
tality - Inner Smile, Six Healing Sounds**, Mantak Chia.
#B0190 ... \$10.95

**The Amazing Secrets of the Masters of the
Far East**, Victor Simon Ferrara. #B0003 ... \$8.95

**Theories of the Chakras: Bridge to Higher Con-
sciousness**, Hiroshi Motoyama. #B0230 ... \$9.85

One Thousand Years Ahead, Dinshah P.
Ghadiali. #B0208 ... \$49.95

Postage & Handling - add \$2.75/ first item, plus \$1 each additional item.
California residents add 7¼% Sales Tax. Visa/Mastercard orders call (707) 986-7211

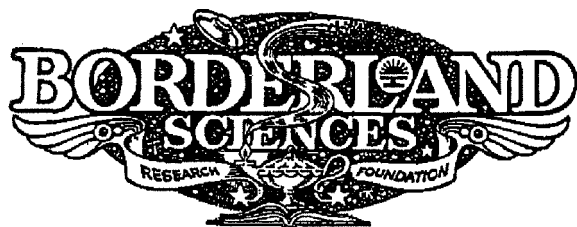

P.O. Box 429 ★ Garberville, CA 95542 ★ U.S.A.

FORWARDING POSTAGE GUARANTEED
ADDRESS CORRECTION REQUESTED

BULK RATE
US POSTAGE
PAID

Tarpon Springs, Fla
Permit No. 37
Zip Code 34689