



Flying Saucer Review

Volume 47/4
Winter 2002



POLICE CHASE UFO OVER BRIGHTON (artist's impression)

CONTENTS

UFO Filmed from Sussex Police Helicopter over Brighton.....	ii
Editorial: Will We Ever Know?.....	1
Earlier Police Filming of UFO off Brighton Beach.....	2
Another Look at Adamski's Photos, by Gordon Creighton.....	2
Book Review -UFOs and Abductions: Challenging the Borders of Knowledge.....	6
Why UFOs Are Hostile, by Jerome Clark.....	6
The Human-Looking Aliens, by R. P. Collins.....	9
Chupacabras Widespread: The Enigma Grows, by Jorge Martín.....	14
UFOs Escorted by Mysterious "Military Men" in Black? by Jorge Martín.....	19
Readers' Letters.....	25
A Big Thank You to Our Readers.....	25

POLICE FILM UFO OVER BRIGHTON BY NIGHT.



Clips from colour footage filmed by Sussex Police helicopter team.

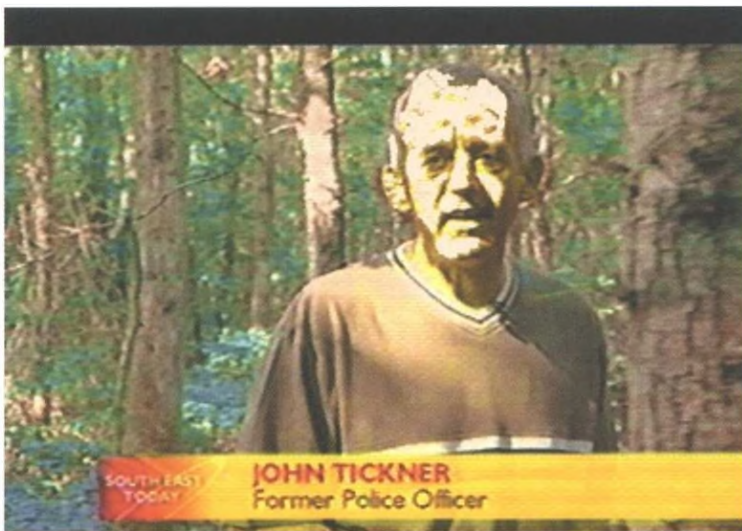

Witnesses John Tickner, left, and Sean Mitchell, right.

BBC SOUTH-EAST TODAY. 11/08/2000.

I felt truly dismayed when I watched this footage again for the second time. A genuine news story about -whatever it was -is intentionally interwoven with fictional footage from the film "Men in Black" -and they have the last laugh. Why bother to report it all? -I ask myself. Also, the treatment is an insult to the bona-fide witnesses -trusted, in their capacity as police, to observe accurately! This is a typical example of "dismissal by derision", a standard tool employed by the press and media. The transcript follows (videotape courtesy Hugh and Lilly Gatter). Text in [brackets] is my own comment, as also is this paragraph, which is an expression of my personal opinion only -Philip Creighton:-

0020 Female commentator: "Right, next tonight, some video footage of an unidentified flying object in the sky over Sussex is causing quite a stir amongst UFO watchers [they are nerds, a bit like train spotters]. It was filmed by a Sussex police officer in a Force helicopter which chased the glowing object at more than one hundred and forty miles per hour across the skies. **Ian Palmer** has the story."

0050 Clip from "Men in Black": 'People -we have a Bug in our electrical system!'

Ian Palmer: "Aliens and humans living on Earth side-by-side.

Hollywood's version of the unexplained, portrayed in highly entertaining fashion. But is 'Men in Black II' pure fantasy, or could there be a smattering [another word for nothing] of cold reality in this glossy tale of the metaphysical?" [in *NewSpeak* this means something vaguely to do with God or mysticism, and probably therefore suspect.]

0075 Cut to "Men in Black" -shows UFO in helicopter camera sights, [with hypnotic music in background.]

0095 Continuous, ungraded transition to real footage [It's not at all clear which is which -with the same hypnotic music in the background]: **Ian Palmer:** "This image was filmed by a police helicopter team. It was spotted travelling over Brighton. Officers followed it for about ten miles. None of the crew members on board the helicopter had seen anything like it before, or since." [Here the real footage is shown; you see a glowing orange object moving against a background of the city lights, which then disappear, leaving the UFO alone as it moves out to sea. The same hypnotic music continues right through.]

0111 Cut to interview with John Tickner, former Police Officer [why are we talking to a former police officer here??] [same hypnotic music continues in background as he speaks]: "We are just puzzled,

really, as to what it could be, in our airspace. We're not used to seeing too many other -airborne things -over Brighton. Normally it's, it's just -us.

00120 Cut to interview with Sean Mitchell, paramedic [same hypnotic music continues in background as he speaks]: "As soon as I saw the object -out of the window- I identified it to the pilot, because obviously we're concerned about -other aircraft flying in our airspace, particularly at night time, and at that low level. We then manoeuvred the aircraft so that we could -uh- capture it on our film on the infrared camera, and do our best to identify it what it was..."

0137 Cut to replay of real footage again. Meanwhile, **Ian Palmer** says: "Whatever it is, the footage has aroused the interest of UFO enthusiasts [again, they are bit like train spotters, aren't they?]"

0146 Cut to Interview with David Bickenden [very serious-looking UFO Expert, aka trainspotter, shot from a funny angle to make him look a proper nerd, real footage still playing, as also the same hypnotic music]: "Ninety-eight percent of sightings can be explained. it's always the other two percent -that are unexplained, and therefore you have to look at the possible two percent being -the

possibility of extra-terrestrial life forms, and -are they visiting our planet?"

0167 Cut to Interview with John Tickner, again [shot to make him look a real slouch, and hardly credible; hypnotic music continues in background]: "I never imagined it was going to be little green men, although we did share a little joke about it at the time, and talked about waving to them -we decided we'd wave to them, just in case it was -we'd give them a wave."

0174 Cut to Men in Black, fictional UFO footage:

0180 Ian Palmer [holding black glasses] [hypnotic music has now stopped!]: "Was it UFO? Nobody knows. But - in a few seconds -you WILL forget -everything you have just seen." [dons black glasses, and holds up a mini Star Wars light sabre].

0188 Female Commentator [laughing]: "Ha, ha, ha! May the Force be with you!" So, do you think flying saucers exist? What do you think those pictures really show? [you are now shown a brief clip of the fictional MIB footage again.] You can have your say on bbc.co.uk/forward/slash/kent." ■

 <p>FLYING SAUCER REVIEW</p>	<p>ESTABLISHED 1955. Vol. 47 No.4, Winter 2002.</p>
<p>© Flying Saucer Review. Library of Congress copyright. FSR Publications Ltd, 1981. Contributions appearing in this magazine do not necessarily reflect its policy and are published without prejudice.</p>	

HOW TO REACH US AT FSR:-

Write to the Editor at:
FSR Publications Ltd,
P.O. Box 162, High Wycombe,
Bucks. HP13 5DZ, UK.
or write to our e-mail box at:
fsreview@hotmail.com

EDITORIAL: WILL WE EVER KNOW?

We note with interest that, particularly in the U.S.A., UFO journals are still devoting an enormous amount of space to reports of sightings of craft, usually huge, and triangular or deltoid in shape.

As for ourselves, we have for some time past not made any attempt to present such reports. This is partly because of lack of space (note that we do try to report on cases which involve more than mere sightings, for example involving military pursuit -See Readers' Letters), and partly because of our own conclusions.

Personally, I cannot believe that, as so many skeptics and critics maintain, all of these enormous craft are quite possibly simply part of the latest and most secret weaponry of the U.S. Air Force. The latter may be extensive and sophisticated, but it cannot account for the numbers and performance of the kinds of craft seen.

At this juncture, perhaps I should invite our readers to indicate whether they *would*, in fact, like us to report more on simple sightings.

As for my personal opinion about all this extensive activity, I can only conclude that, wherever it comes from, from whatever source, level, or dimension, it does not represent the behaviour of somebody from somewhere else who is anxious to make contact with us in any overt sense, or to socialise in any way.

I consider it far more likely that all this activity is connected, not so much with ourselves, as with the coming Earth changes which have been indicated by many sources to be imminently impending -the revelations of Fatima, the predictions of Edgar Cayce and of many more contemporary seers and psychics, as well as Biblical prophecies. -G.C.■

UFOS IN THE NEWS. © BY D.J. AND I.D. STRUDWICK: EARLIER POLICE FILMING OF UFO OFF BRIGHTON BEACH.

On Friday August the 3rd, 2001, at 10.30 to 11 pm, the ITV channel broadcast their programme 'Crimefighters' in which an ITV film crew goes out in a police helicopter equipped with thermal imaging camera to see stolen cars, criminals running away etc. However, when they were told to go to Brighton Beach after dark, to surveille (!?) the fires lit by revellers on the beach, their attention wandered to showing a UFO coming towards them from out to sea! - a round-ended cylinder

about four to six feet long, NO wings, propellers, jets, rotors or lights. And silent!

They only saw it because they had thermal imaging gear, and followed it as it circled them and went out to sea again!

The crew chortled and guffawed and said they waved to the aliens as they went past! (I suspect that it was only a remotely controlled camera operated from a big UFO elsewhere). ■

ANOTHER LOOK AT ADAMSKI'S PHOTOS. BY GORDON CREIGHTON.

I am sure that many readers must have noticed the similarity between the artist's impression of a giant cigar-shaped UFO seen over the Yukon (FSR volume 47/3), and that claimed to have been photographed so many years ago by George Adamski.

We reproduce here the Adamski pictures and that which appeared on the cover of the last issue of FSR (i.e. volume 47/3). In both cases the front of the craft appears to be to the right, with the "scout ships" emerging from the back. ■

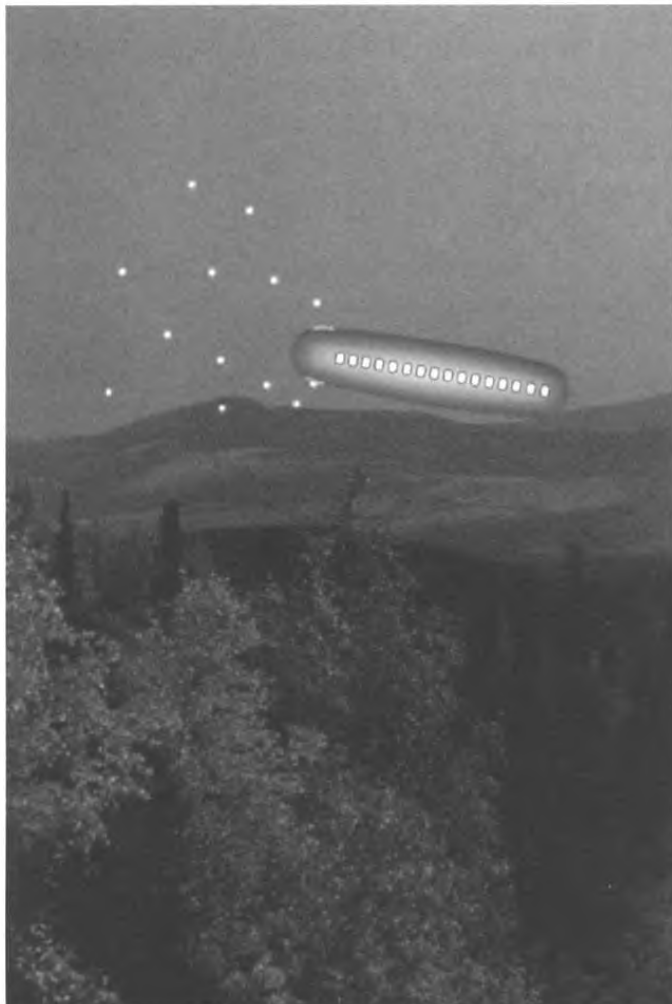

Giant UFO Seen over Yukon.

SPOT THE UNINTENTIONAL MISTAKE? -MY APOLOGIES TO MARTIN.

Readers of our last issue, volume 47/3. in which we reproduced the excellent article by Martin Jasek, may well have been disconcerted by Fig. 5 -which is clearly a duplication of Fig. 4. This is my mistake, and I now reproduce the picture of the Gold Rush Girls -with my apologies. -Philip Creighton.



Fig. 5. Today, Dawson City is a popular tourist destination, population 4000 in the summer, 1000 in the winter. Above Diamond Tooth Girdie and the Gold Rush Girls entertain tourists. Tourism as well as gold that swells the population of Dawson in the Summer bringing in people from afar looking for employment and adventure.

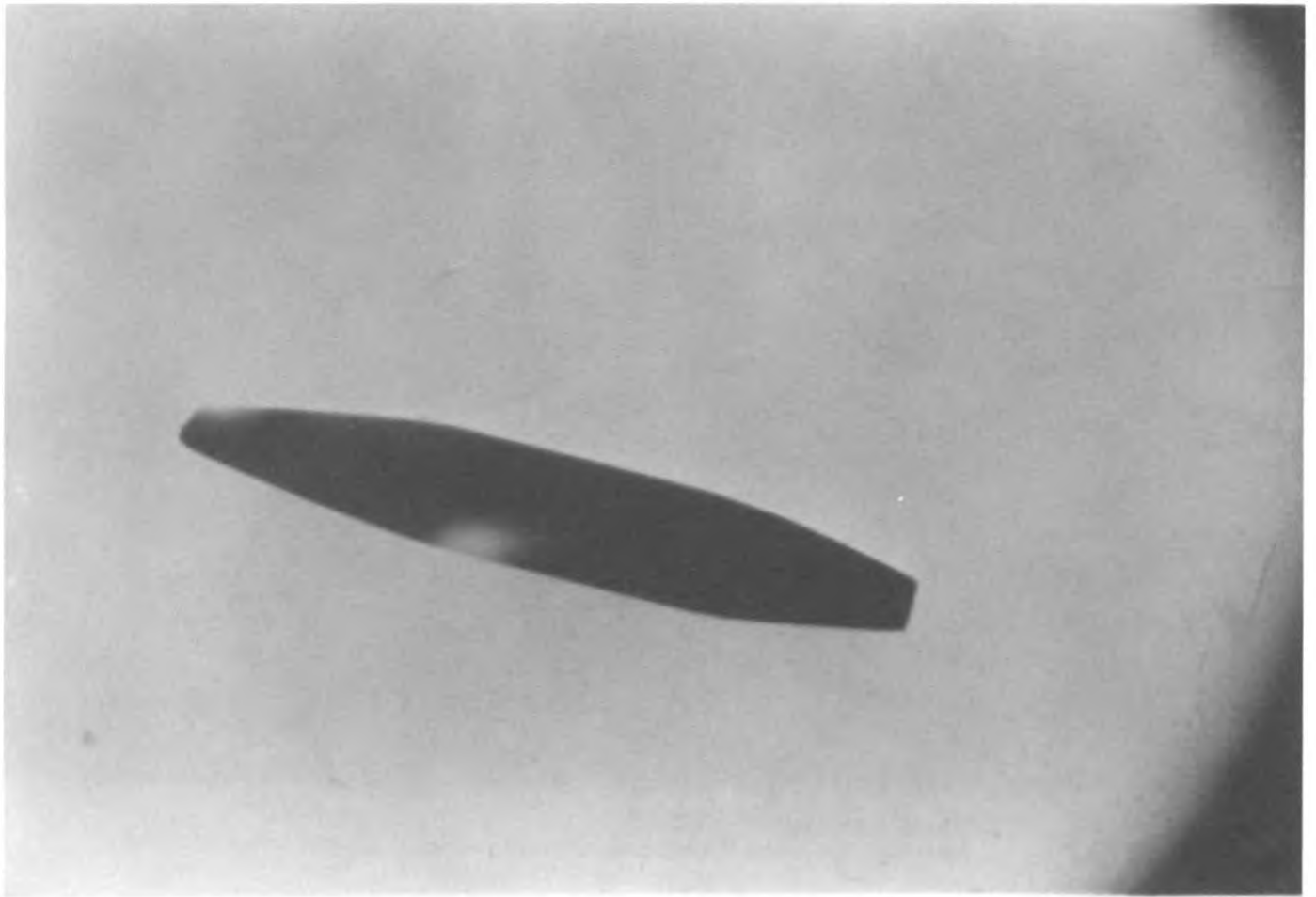

© Adamski

Mother Ship Releasing Scouts # 1
The following three photographs were taken immediately after this one on March 5, 1951 at 10:30 a.m. by George Adamski. Here only one Scout has begun to leave.



© Adamski

Mother Ship Releasing Scouts # 2
Two Scouts have taken off.

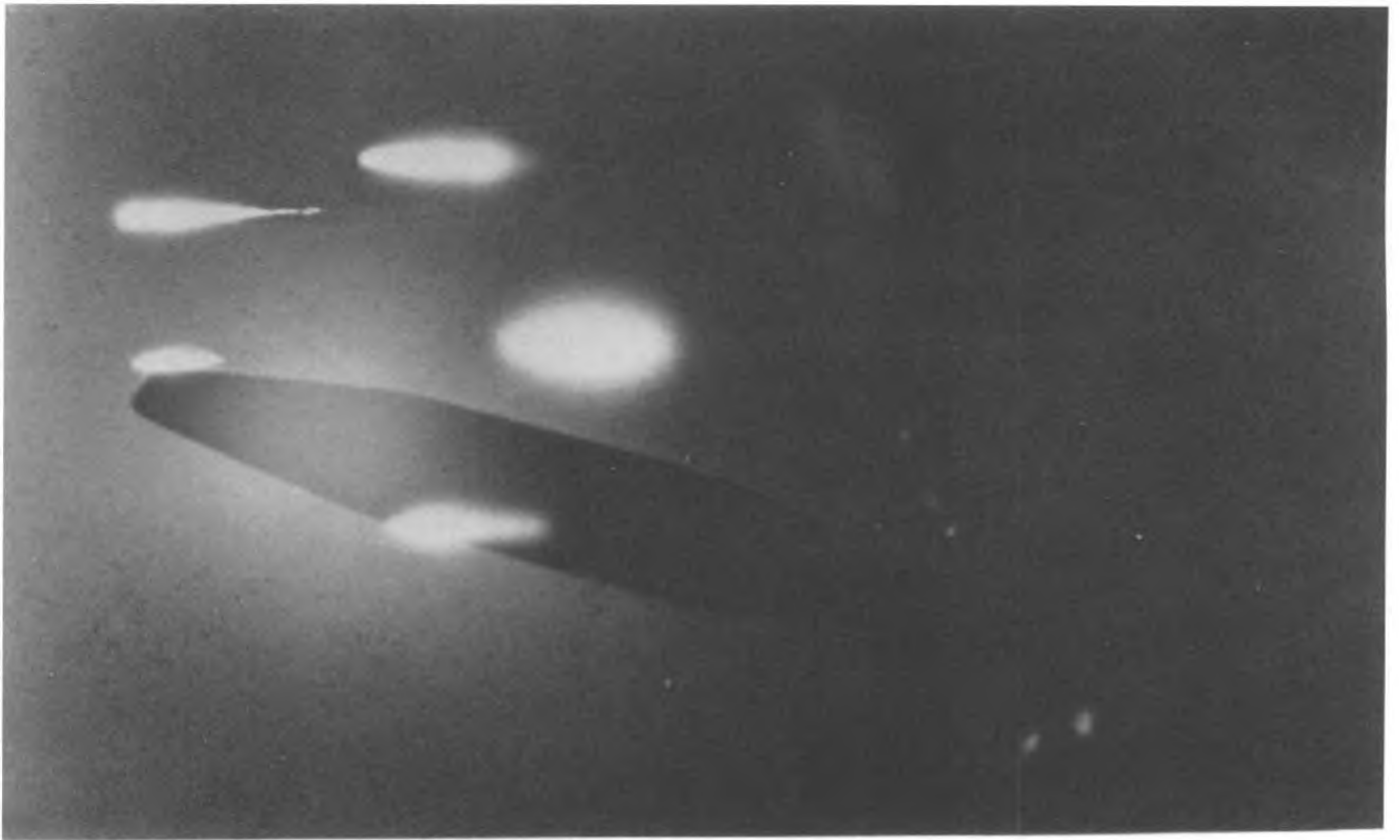

Mother Ship Releasing Scouts # 3
Now five Scouts have slid down the sloping rail, through two air-locks and out into space through the bottom of the ship. (See closing portion of Chapter 6.)



Mother Ship Releasing Scouts # 4
Now six Scouts are to be seen, in this last of the rapid series of four telescopic pictures taken by George Adamski.

© Adamski

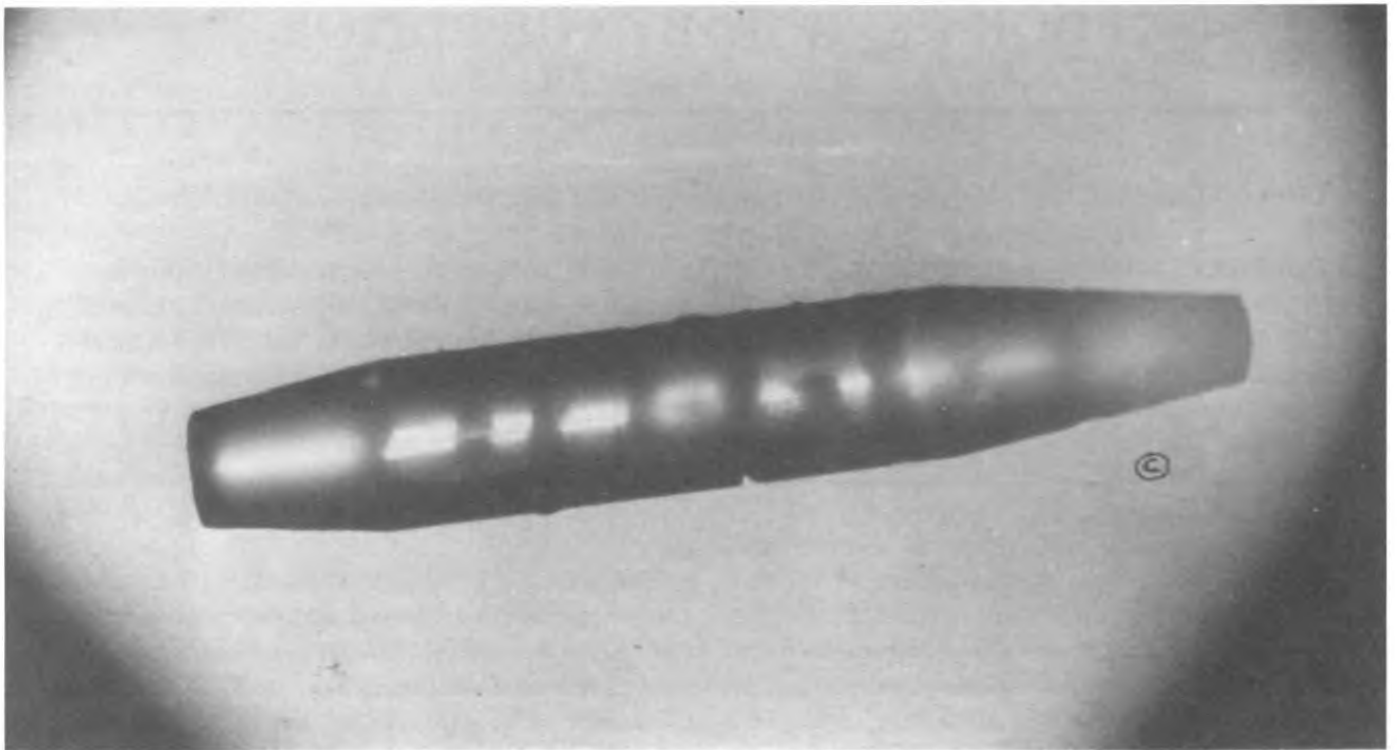

CIGAR-SHAPED SPACE CRAFT

A similar giant carrier ship appeared again at 7:58 a.m. 1 May 1952. It was of a shining silvery appearance and almost identical to the one that brought the visiting 'Scout Ship' six months later on 20 November. This

telescopic photo was taken as it hovered over a mountain peak some thirty miles distant. Notice the complete absence of any streamlining for in space such refinements would be unnecessary.



Submarine Type Space Ship

Specially built to plunge into our seas as well as travel through space. Photographed March 9, 1951 at 9 a.m. by George Adamski with six-inch telescope at Palomar Gardens, California.

© Adamski

BOOK REVIEW. BY THE EDITOR.

UFOS AND ABDUCTIONS: CHALLENGING THE BORDERS OF KNOWLEDGE.

Edited by Dr. David M. Jacobs. PhD. 382 pages, Hardback, with index, selected bibliography and chapter notes. Chapters by Dr. David Jacobs, PhD, Dr. Stuart Appelle, Ph.D., Dr. Thomas E. Bullard, Ph.D., Jerome Clark, Dr. Don Donderi, PhD., Budd Hopkins, Dr. John E. Mack. M.D., Dr. Michael Persinger, PhD., Dr. Michael Swords, PhD., and Dr. Ron Westrum, PhD., Published in 2,000 by the University Press of Kansas, \$34.95. ISBN 0-7006-1032-4

As can be seen, this list of contributors to the book contains the names of most of the U.S. scientists who are known to be interested in UFO research and, between them, they seem to say pretty well all that has been said so far by the scientific community, so I feel that there are no particular points in their arguments that would require mention here.

[The publishers, University Press of Kansas, have asked for any comments that we wish to make, so I am sending them two copies of this issue of FSR.]

NEVERTHELESS it is most important to note that, in this panoply of "the world's finest scientific minds", it is astonishing to find, also, the name of Dr. E. Mack, Professor of Psychiatry in the Harvard Medical School at the Cambridge Hospital, U.S.A. His contribution, Chapter 9, *HOW THE ABDUCTION PHENOMENON CHALLENGES THE BOUNDARIES OF OUR REALITY*, is as fine and clear as anything that this remarkable man has ever written. It seems gravely out of place here among this lot. (Could it possibly have got slipped in through some dreadful mistake?)

A second very striking feature of the book is the fact that its Editor is that same Dr. David Jacobs who wrote *THE THREAT* (published in 1998). Every one of us is free to speculate as to what could have brought about such a change in Dr. Jacobs' thinking in such a brief span of only two years, and even to wonder who - or what - may have even "got at him"!

Undeniably one of the main features of this book is that it tells us a great deal about *paranoia*, and *paranoia* in more than one quarter, for on page 138 Mr. Jerome Clark has this to say:

"A new generation of ufologists grew ever more taken with paranormal 'theories' about UFOs. Such notions, embraced by the influential British publication *Flying Saucer Review* under the editorship of the relatively restrained Charles Bowen, and, later the deeply paranoid Gordon Creighton, amounted to a thinly disguised demonology, in which malevolent shape-shifting entities pretended to be friendly extra-terrestrials in order to manipulate or even destroy their naive human contacts".

In the days of his prime, between 1961 and 1979, the name of the veteran Jerome Clark had appeared on 31 fine and interesting contributions to our pages (25 articles,

and 6 letters to the editor). The sudden illness of Charles Bowen made it necessary for me to take over the editorship of FSR in November 1982. Jerome Clark's last piece was in 1979, and, sure enough, there was no more after November 1982.

In view of my own allegedly high rating for *paranoia*, our readers will surely not be too surprised if I say that my favourite piece by Jerome Clark is this article which I republish below, *WHY UFOS ARE HOSTILE*, which had originally appeared on pages 18 - 20 of FSR 13/6 (November/December 1967).

WHY UFOS ARE HOSTILE.

© BY JEROME CLARK.

On a day in late summer 1939, a military transport left the Marine Naval Air Station in San Diego, California, for a routine flight to Honolulu. About three hours afterwards, several urgent distress signals sounded from the plane, and then silence. Later, the craft came limping back to execute an emergency landing. When Air Station personnel entered the plane, they found every man of the crew, including the co-pilot, who had lived long enough to pilot the craft back to its base, dead of unknown causes.

Each of the bodies carried large, gaping wounds, and the outside of the ship was similarly marked. Air Station men who touched parts of the craft came down with a mysterious skin infection.

One of the most puzzling aspects of the whole affair was that the .45 automatics carried by the pilot and co-pilot as service pieces had been emptied and the shells lay on the floor. A smell of "rotten eggs" pervaded the atmosphere inside the plane.

Was this 28 year-old air disaster an early case of UFO hostility? "Mysterious skin infections" (1) and "rotten egg" odours (2) are phenomena familiar to all UFO researchers. It would seem that the transport was attacked - apparently without provocation - by some sort of strange aerial intruder.

On the basis of incidents similar to this one, Brad Steiger and Joan Whritenour, in their recent *Flying Saucers are Hostile* (Award Books), have concluded that at least some UFOs are visiting the earth for malevolent ends. "There is a wealth of well documented evidence,"

they write, "that UFOs have been responsible for murders, assaults, burnings with direct-ray-focus, radiation sickness, kidnappings, pursuits of automobiles, attacks on homes, disruptions of power sources, paralysis, mysterious cremations, and destruction of aircraft."

A bit strong? Perhaps. But the material they have gathered is certainly unsettling, more than enough to expose the fallacies inherent in sentiments like those expressed by a recent contributor to these pages: "The extraterrestrials, although they may have badly frightened us, have not, so far as we know, deliberately caused any of us serious bodily harm, nor have they used lethal weapons against us. This cannot be said, alas, on our side. Unavoidable accidents may have occurred... but no deliberate act of aggression causing death has been made against us." (3)

From *UFOs Are Hostile*, and the independent research I have done on the question, I dare say that a case might be made for the remarkable restraint on our part. Although on a number of occasions jet interceptors have been scrambled to check on UFOs, there are very few instances in which these aircraft have fired on the saucers, and then only because some action of the ufonauts frightened the pilots. Keyhoe, for example, cites an incident wherein a UFO abruptly switched direction and seemed to be trying to ram the jets which were pursuing it, forcing them to open up with rockets - to no avail, evidently. (4).

There is, of course, the inane "self-defence" plea of certain apologists, who maintain that, because the UFOs are somehow menaced by us and our weapons (puny in comparison with those the UFOs possess), they must strike back to save themselves. Thus, the F89 at Kinross Air Force Base was abducted because the UFO had to "defend itself" - a curious notion since - rather than fleeing, which it could easily have done - the saucer flew directly *towards* the aircraft.

We should also remember that, while flying saucers have ostensibly downed more than a few of our planes, we have *never*, so far as is known, forced a UFO to crash, nor often tried to knock one down. I am inclined to think that we are treating our visitors with more respect than they deserve.

On the other hand, I find it very difficult to believe that the ufonauts are in the early stages of an invasion plan, as Steiger and Mrs. Whritenour profess to feel. The UFOs may be "hostile", but that is not all that can be said about them. After all, they are "indifferent", and, indeed, even "friendly" *when the occasion calls for it*.

What it comes to is this: Because UFOs have killed and injured seemingly innocent persons, we should not conclude that the saucers have sinister motives (at least, I mean, on those grounds alone). Because UFOs usually do not bother us, we should not conclude that they are indifferent to us. Because UFO beings are sometimes kind to us (as in some some contact claims), we should not conclude that they like us. We should conclude, though, *that they are intimately concerned with us - to the extent that they have gone to fantastic lengths to prevent us from knowing what they are doing*.

In earlier articles (5) I approached the issue from the

opposite corner: those claims in which ufonauts have evinced "friendliness". Let me restate my arguments briefly. In contact claims (such as those of George Adamski, Sid Padrick, and Professor Guimaraes) the ufonauts have planted a fairly consistent image of themselves, relative both to their origins and to their purposes.

In communication with human beings in post-Arnold times, the entities usually pass themselves off as benevolent beings from Venus (or other planets) whose coming is stimulated by a desire to save the human race from destroying itself. Yet there is absolutely no objective evidence, other than the contact stories, that the UFOs are either interplanetary or "friendly" in the human sense; but there *is* objective evidence that some of these contacts took place as described. The implication, then, is that the ufonauts are lying.

In the 1896-97 American flap, the UFO occupants flew crafts that resembled in structure, if not in performance, "airships" that the technology-oriented people of the late Nineteenth Century expected to see built in a very few years. Consequently, it was widely assumed that the ships had been invented and constructed by an American engineering firm. Now, of course, we know this was not the case, and that the "airship" is related to the "flying saucer" phenomenon of today.

So how does "hostility" fit into the pattern? Hostile actions are effected, the evidence hints, to cover up the "loose ends", to keep us from seeing behind the veil - to prevent anyone from exposing (if Mrs. Lorenzen will forgive me) the Great Flying Saucer Hoax.

Dr. Jacques Vallée, in his books and articles, has assigned "weight" to UFO reports. The best-authenticated are assigned "heavy" weight; the most poorly-authenticated, "low" weight. I suppose that some such classification system is necessary, and I certainly do not presume to criticise his approach. But I think that, as we come more and more to realise what the UFO mystery involves, ufologists will develop a different "weight" concept, to separate significant and insignificant reports - and this will have very little to do with the quantity or quality of witnesses.

We will eventually decide, no doubt, that the account of a peasant who witnesses a landing will "weigh" more than the account of a physicist who sees a peculiar light high in the sky. As John A. Keel has pointed out. (6) some reports are merely of "cross-overs," i.e. movements from point to point: But more ominously, other sightings are diversions, designed to draw attention away from the real object of ufonaut interest. In the Ravenna, Ohio, case - which Keel mentions specifically - the sighting at the arsenal would be "heavy", under the new system, while the police chase, despite the quality of the witnesses, would be "low". (7)

It ought to be very evident that the "hostility" incidents deserve the greatest weight of all. For in them we can see the ufonauts desperately covering up activity that reveals more about them than they dare reveal. Apparently certain actions of theirs are not meant to be observed, and seeing what should not have been seen has proved fatal to hundreds, possibly thousands, of persons around the

world. Consider a tragic incident recounted by Steiger and Whritenour:

In June 1954 an 11-year-old African boy named Laili Thindu and several companions watched odd lights flying over and landing on Mt. Kenya. The UFOs appeared to be involved in intense activity of some kind.

One night a short while later, a fleet of glowing objects swooped over a nearby village, beaming down bright rays of light. Laili Thindu witnessed the spectacle in astonishment, but not until the next day did he learn that *the entire population of the village had been seared to death.*

A brutal, vicious attack, surely, but not pointless. Whatever was being done on Mt. Kenya was of sufficient importance to the UFO beings to cause them to destroy all the witnesses. The boy survived, however, and carried his story to the authorities in Nairobi. (8)

The two young Swedes, Hans Gustavsson and Stig Rydberg were more fortunate. Returning from a dance at 2.55 a.m., they saw a light shining through an opening in the trees, where a UFO was not quite successfully concealing itself.

As they walked toward the craft, according to Rydberg: "All of a sudden we were attacked by four lead-grey creatures about four feet tall and about fourteen inches in breadth." The beings attempted to drag the men into their craft, but Rydberg escaped to the car and began to blow the horn. Frightened, they let go of Gustavsson, retreated to their ship, and flashed away. (9)

Again, the witnesses seemed to have stumbled upon a secret operation. Determined to keep them quiet, the ufonauts attempted to steal them away, but the blowing of the car horn (which might have brought more people to the scene) forced them to flee before even more damage could be done.

Mr. James Flynn of Florida, sleeping in a swamp, was awakened by his dogs, and saw a lighted object in the distance. When he approached it and tried to communicate, something or someone knocked him unconscious for over 24 hours. "A dismal swamp", the good Dr. Hynek assured us when he visited Michigan in March 1966, "is a most unlikely place for a visit from outer space." (How he knows this is a mystery). A "dismal swamp" is, quite to the contrary, a most *likely* place for a visitor who does not care to be seen or disturbed.

There are many similar cases. They usually occur in secluded areas in the darkness, and the witnesses are often paralysed, as was Marius Dewilde; injured, like Flynn, or Jesus Paz; killed, as were Miguel Jose Viana, and Manuel Pereira da Cruz; kidnapped, like Rivalino Mafra da Silva. Some incidents have special twists: Jose Viana and Pereira da Cruz apparently established contact with ufonauts and learned so much that they were lured to a Brazilian hillside and done away with. (10)

Mafra da Silva, three days before his disappearance, saw two little men digging a hole. Suddenly aware of his presence, they fled into their craft and flew away. (11) Mr. S. at Cisco Grove, California, stumbled onto a nighttime UFO operation in the middle of a deep forest. Appearing to fear he had seen too much, several ufonauts went to incredible effort in an abortive abduction try. (12)

The Barney and Betty Hill encounter adds a new dimension to the problem, with the erasing of the participants' memory of a UFO experience. (13) A similar incident, which allegedly took place in Brazil in November 1961, has recently come to light. (14) A little known contact has it that an American working in Austria in 1951 had his memory preserved only because a dog's barking frightened the ufonaut away at the last minute. (15) Ufologists are investigating other "memory lapses" right now.

Air disasters like the one described at the beginning of this article might be explained not as random attacks but as strikes necessitated by the aircrafts' crew and passengers having come upon secret UFO activities which, if reported, could provide valuable clues to informed terrestrials.

I feel that I should mention in passing the rather startling work of an American investigator who has discovered that mysterious individuals of decidedly odd physical appearance are threatening and sometimes attempting to kidnap witnesses to certain UFO sightings. These men, whoever they are, do not seem to be government agents, but they *are* determined to keep some people from talking.

As I have said, "hostile" incidents do not in themselves prove that the over-all plan of the UFOs is dangerous to us. But neither do they show that our visitors are the patient, all-wise, god-like figures in whom some UFO students (perhaps victims of the breakdown of traditional religion) insist on believing, despite all the evidence to the contrary.

The UFO, as the works of Paul Misraki (16) and W.R. Drake (17) have indicated, is a phenomenon at least as old as civilised man. The UFO holds a highly significant place in the history of humanity, and some imaginative theorists have suggested that these extra-mundane intelligences have secretly guided us - or used us.

Who knows? It is too early for us to speculate intelligently on the nature of the UFO mission. But we are involved in it to the extent that it would be to the ufonauts' detriment for us to know about it. So they act positively and negatively in their dealings with us.

Positively, they seek contact with human beings and deliberately mislead those daring and presumptuous enough to believe in their existence to start with. (They don't have to bother with the sceptics, of course!)

Negatively, they destroy or drive away those who, however briefly and imperfectly, have seen through the facade. The ufonauts could behave in this manner whether their motives happen to be "good" or "bad" for us (probably only an incidental question to them) - just so long as their purposes are concealed from us.

All of which makes UFO research infinitely more difficult. But we can learn. We can reject the "obvious" conclusions, i.e., what we are *supposed* to conclude, and we can begin all over again, paying special attention to the cases that don't "fit", which will be a tiny minority of reported sightings - and the most important.

Particular attention should be paid to incidents that occur in backwater areas, where encounters with ufonauts are accidental and where the ufonauts probably do not

expect to find human beings. The Cisco Grove story is a prime example, and so is Flynn's Florida report.

The results of this new approach to UFO study should bring us closer to the truth than we have ever been before.■

REFERENCES.

- (1) The Merom, Indiana, case (Rene Gilham) of November 1957, and others.
- (2) The Flatwoods, West Virginia, landing of September 1952, and others.
- (3) Ivan Brandt, *The Problem of the Frankensteins*, FSR, May/June 1967.
- (4) We might add that the governments of the world have generally afforded the UFOs *preferential treatment*. The objects have *not* been treated as enemy aircraft, which would have immediately been blasted from the skies.
- (5) Jerome Clark, *The Meaning of Contact*, FSR September/October 1965, and *The Strange Case of the 1897 Airship*, FSR, July/August 1966.
- (6) John A. Keel, *North America 1966: Development of a Great Wave*, FSR, March/April 1967.
- (7) "... the Ohio incident ... began near Ravenna, Ohio, the site of a large government arsenal. While the two police officers were dashing across the countryside in pursuit of their dome-shaped cloud of swamp gas [sic], a reddish circular object was operating at ground level around the arsenal. This appears to be a case of pure diversion and misdirection. By luring the local police away from the area, the UFOs were able to make their visit to the arsenal without interference.
- (8) A recent article in *Sports Afield*, an American outdoor magazine, claims that a tribe of Indians in Alaska has a tradition that "Sky People" regularly land in saucer-shaped vehicles on mountain ranges and abduct individuals who come upon them.
- (9) For a complete account, see Coral E. Lorenzen's *Flying Saucers: the Startling Evidence of the Invasion from Outer Space* (Signet, 1966 -a revised, updated paperback version of *The Great Flying Saucer Hoax*) pp. 60 - 64.
- (10) Charles Bowen, *The Mystery of the Morro Do Vintem*, FSR, March/April 1967.
- (11) Coral Lorenzen, *The Disappearance of Rivalino Mafra da Silva: kidnapped by a UFO?* FATE June 1963, See also
- (12) Coral Lorenzen, *UFO Occupants in United States Reports*, THE HUMANOIDS (FSR Special Issue, October/November, 1966, pp 61-63.
- (13) John G. Fuller, *The Interrupted Journey* (Dial Press, 1966)
- (14) Coral and Jim Lorenzen, *Flying Saucer Occupants* (Signet, 1967), pp. 199-200.
- (15) *Prince George Citizen*, 1957. See also Charles Bowen: *Fantasy or Truth?* FSR, July/August 1967.
- (16) Paul Misraki (writing as "Paul Thomas"), *Flying Saucers through the Ages* (Neville Spearman, 1965).
- (17) W.R. Drake, *Gods or Spacemen?* (Amherst Press, 1964) and *Spacemen in the Ancient East* (Neville Spearman, 1967).

THE "HUMAN-LOOKING" ALIENS. © BY R.P. COLLINS.

(EVIDENCIA OVNI, No. 9 (Puerto Rico,1995) (Translation from Spanish. G.C.)

"The problem is that, along with the reports of "humanoid" beings there were also reports of "human beings" breathing our air and walking around normally on the Earth. The most logical conclusion that you can draw from this is that these beings are humans, or are in some way or other the product of the human imagination. You cannot ascribe them to the biology of another planet, no matter how much you stretch your imagination." -DR. JACQUES VALLÉE. (Interview with *OMNI*, January 1980).

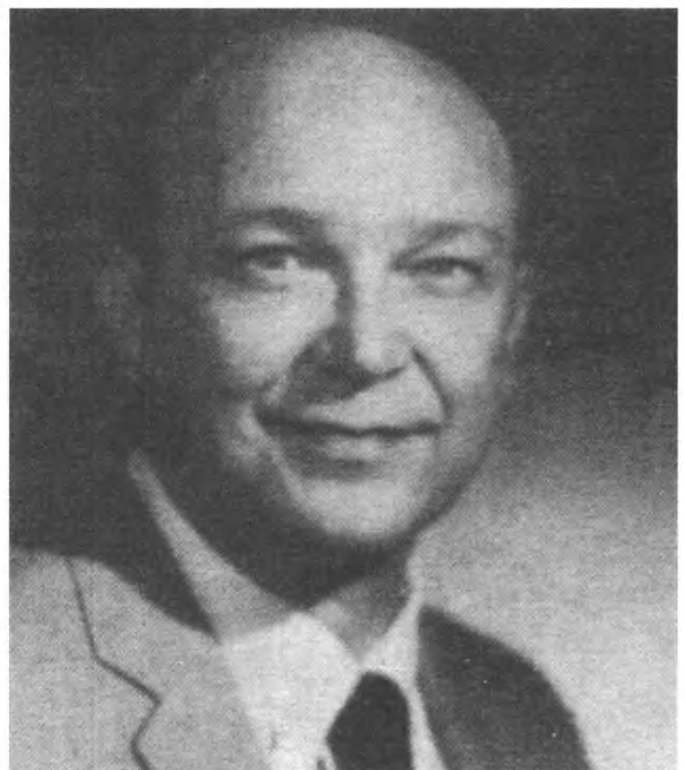

Author: R.P. Collins

There is extensive evidence from the field of Ufology that one group of the supposed alien beings seen in conjunction with UFO events is of completely human appearance. So close is this reported similarity, that it is said that these beings pass along our streets here, as humans, without being noted.

Such a situation, if true, presents us with a dilemma. Human beings - those who we see around us here every day - are the product of a long and intricate process of evolution developed on this planet, Earth.

For human beings identical with us to have evolved on another planet, that planet would have to be practically identical with the Earth in all the aspects of its evolutionary history. This "other" planet would have to have developed identical types of microbes, pre-chordates, identical lines of primates, etc.

Along with that, it would need to have almost exactly the same mass as the Earth, thus producing more or less the same gravity. It would, of necessity, have to orbit a star of the same size and spectral type as ours. That orbit would necessarily have to be at the same distance from its sun as ours is.

This hypothetical other-world would need to be inclined on its axis in its rotation at a similar angle to that of the Earth, simply in order to produce the climatic conditions that have led to our present evolutionary form.

Although some scientists may disagree, it would appear that the number of opportunities for another planet to duplicate the Earth so exactly, even among the uncountable billions of possibilities out there, is almost close to zero.

The humanoid - a form animated with the same functions observable in and characteristic for humans - has numerous advantages which have led to its being dominant on our planet.

Scientists have often commented on the fact that we, out of all of Nature's experiments, have dominated principally due to our adaptable form - we are erect, we are bipeds, with large brains, and we are creatures with opposable thumbs. These features being considered the principal factors that have led to our dominance on the planet, it would seem that other lines of evolution could have duplicated those features in the so-called process of natural selection.

THE 'OTHER' HUMANS.

We have a mass of evidence that, over the past forty years, numerous completely "HUMAN-LOOKING" beings have been seen, all over the world, and in, or in close association with UFOs - and especially UFOs of a



very specific type, namely the "Adamski Scout-Ship" type. (The reports amount to several hundreds.)

From where, then, can they be coming? How are we going to explain this? From where could they be - if not from *our* planet Earth?

THE NEW PHYSICS.

In the last few years, the science of Physics has made some surprising advances in the direction of reconciling some of the most disconcerting contradictions between matter and energy. Mathematical topology, the theory of empty space or cosmic strings [i.e. superstrings? G.C.], the physics of virtual states and the physics of small particles, have begun to unite, presenting us with a glimpse of what we can only define as an infinitely existing and self-conscious Universe.

In effect, experiments have shown that, for all intents and purposes, electrons not only seem to think, but could possess a certain type of *telepathy*, and indeed of *precognition*. And the electrons are not alone in their ingenuity. The entire panoply of small particles appears to possess incredible capacities that somehow enable them to communicate with each other instantaneously over great distances, and make decisions as to how and where they appear. It sounds absurd, but at this point we must describe the Universe of small particles as "*ineffable*".

One especially coherent theory succeeds in explaining a large part of the "Alien Human" mystery. This has been termed "the theory of many worlds", and basically it postulates that the Universe is in a constant state of being created. At each moment, numerous infinities of probable universes arise from the universe that we perceive.

A simple example of this is to be found in the decisions that every one of us makes on waking up every morning. You can choose to get up from your bed and go to work, or you can choose to get up and telephone to say that you are sick, and then go to the beach. Both of these "worlds" - the world of the beach and the world of work - exist as probable states prior to your final decision.

Your possible selection of the world of the beach brings this latter into the reality of your perception. The theory of the "many worlds" postulates, even beyond that, *that the other alternative also possesses a certain degree of reality*, and that it also arises out of another probable "you" which decides to opt for the world of work.

All this may sound somewhat diffuse and ambiguous, but it has a very solid basis in the science of the physics of small particles. The theory implies that many probable worlds do exist, along the lines almost parallel to ours.

COMPARISON OF PHOTOS -PART I.

Adamski photo

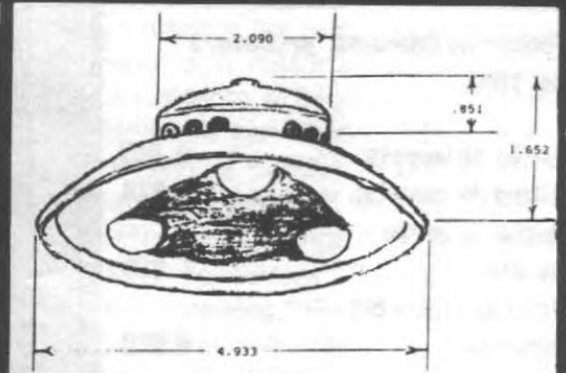
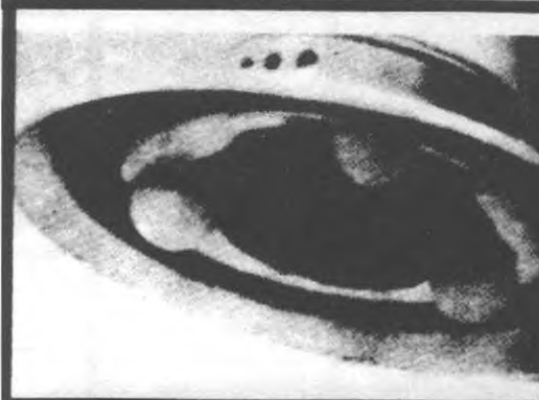

Menger photo

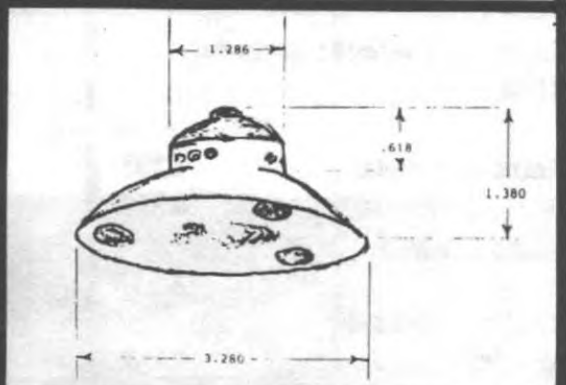

Silver Spring photo

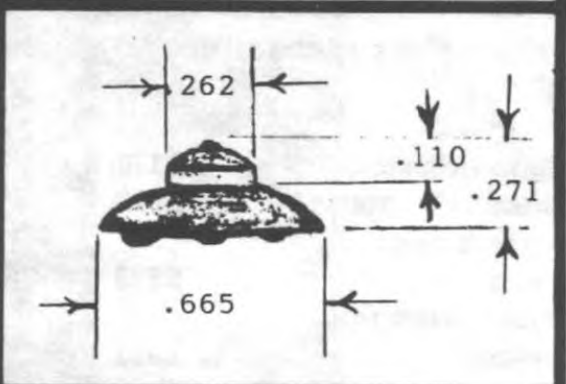
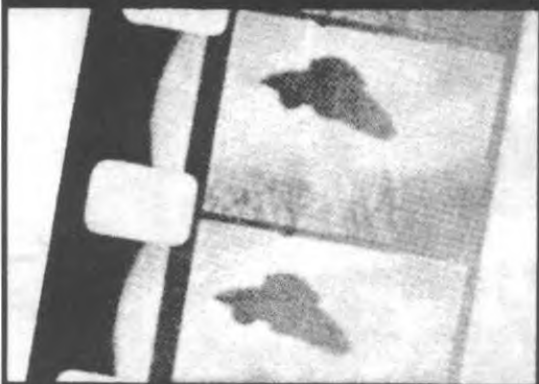

Sheets photo

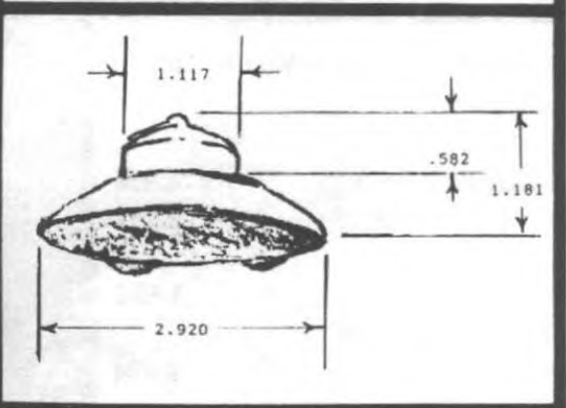

Rosas photo

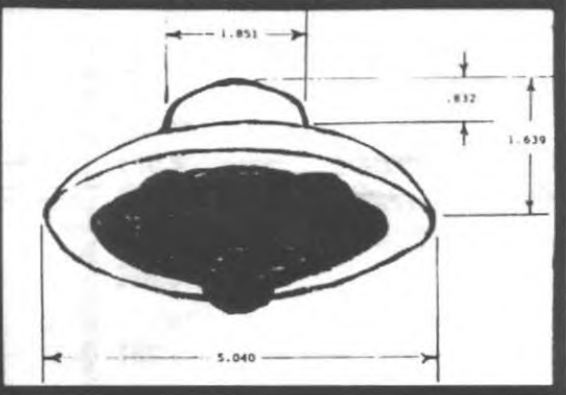
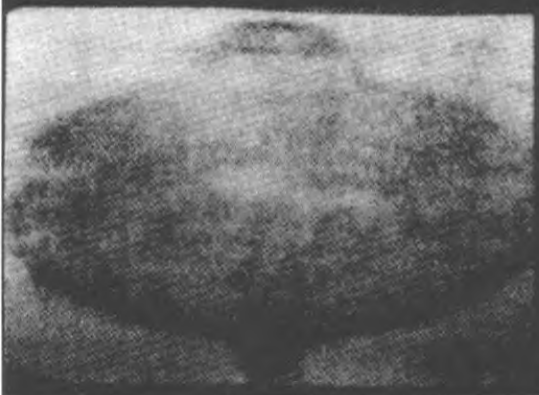

COMPARISON OF PHOTOS -PART II.

Benedum photo

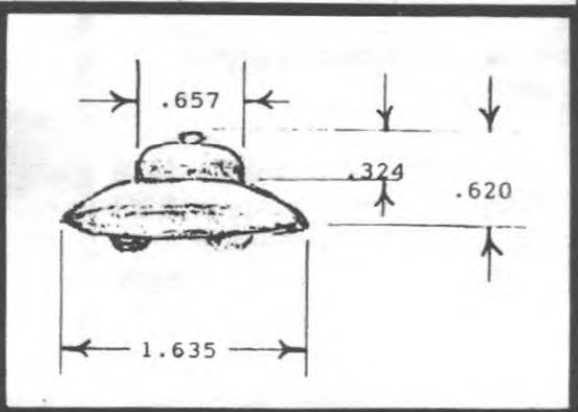
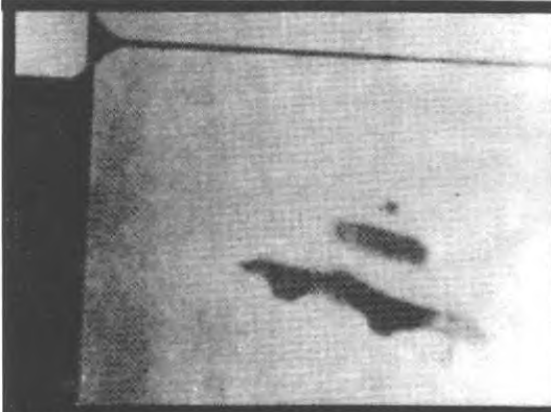

Van Nest photo

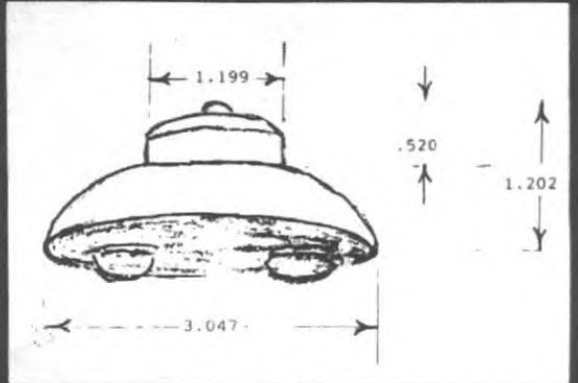

Vega photo

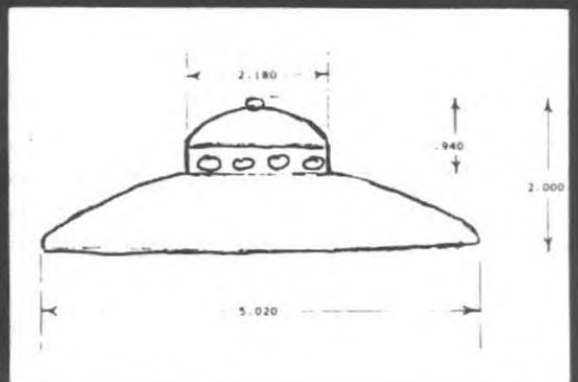

Fujimatsu photo

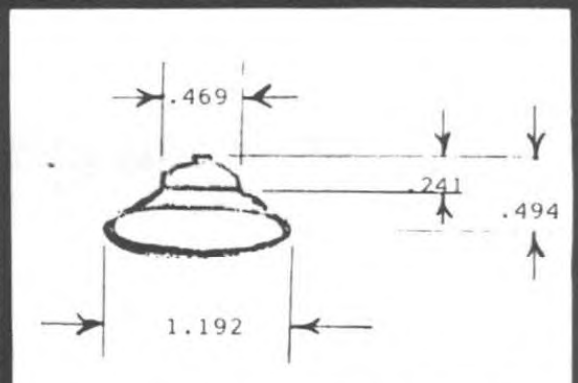

Darbishire photo

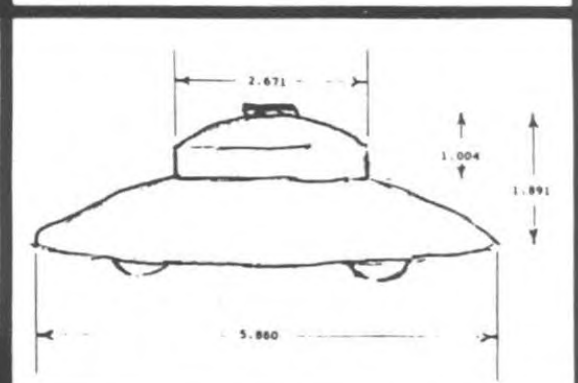

Correlation of cases

Ratio	A/B	A/C	A/D	B/C	B/D	C/D
Adamski photo	2.4559	0.4237	1.2651	0.1725	0.5151	2.9861
Deviation	0.0997	0.0490	0.1776	0.0517	0.0702	0.1238
Menger photo	2.0911	0.3921	0.9319	0.1875	0.4478	2.3768
Deviation	0.0636	0.0292	0.1326	0.0308	0.0696	0.1055
Silver Spring photo	2.3818	0.3940	0.9668	0.1654	0.4059	2.4539
Deviation	0.0665	0.0245	0.1001	0.0907	0.1567	0.0765
Sheets photo	1.9192	0.3825	0.9458	0.1993	0.4928	2.4725
Deviation	0.1406	0.0530	0.1196	0.0957	0.0239	0.0695
Rosas photo	2.2248	0.3677	1.1243	0.1651	0.5076	3.0705
Deviation	0.0038	0.0896	0.0465	0.0924	0.0546	0.1572
Benedum photo	2.0280	0.4018	1.0597	0.1982	0.5226	2.6371
Deviation	0.0919	0.0052	0.0136	0.0896	0.0858	0.0076
Van Nest photo	2.3058	0.3935	0.9975	0.1707	0.4326	2.5349
Deviation	0.0325	0.0257	0.0715	0.0616	0.1012	0.0460
Vega photo	2.3191	0.4343	1.0900	0.1873	0.4700	2.5100
Deviation	0.0385	0.0753	0.0146	0.0297	0.0235	0.0554
Fujimatsu photo	1.9461	0.3935	0.9494	0.2022	0.4879	2.4130
Deviation	0.1286	0.0257	0.1163	0.1116	0.0137	0.0919
Darbishire photo	2.6604	0.4558	1.4125	0.1705	0.5309	3.0989
Deviation	0.1913	0.1285	0.3148	0.0627	0.1031	0.1662
Principal	2.2332	0.4309	1.0743	0.1819	0.4813	2.6572
Average deviation of Principal	8.6%	5.1%	11.1%	7.2%	7.0%	8.9%

Those worlds that are the most parallel or most close to our own world, being almost identical with the Earth, might well contain human beings like us.

Those human beings might have developed a technology that would permit them to transfer or travel to our world. The tools for the technology of voyages between parallel worlds could be the UFOs. Here, then, we have a possible response to the paradox of UFOs crewed by human-type beings. From the point of view of the "many worlds" theory, they could easily exist without violating what we call the laws of Nature.

The question then is - *what are they doing here?* The answer is that nobody really knows. There are no proofs, no real evidence, regarding their motivations and actions in our world. What is certain however, is **THAT THEY ARE HERE.**

Apart from first-person evidence, the references in the Bible abound with stories about humans apparently endowed with magical powers who have lived together with us since the beginning of History. Today we can call them "Extraterrestrials" or "*Aliens*", or even "*Spacemen*". *In those earlier days they were called*

ANGELS.

They are HERE - of that I am convinced. I myself have had encounters with this type of UFO and with the human-type beings associated with them.

Who they really are and what they are really doing in our world still remains to be seen. *But let us hope that the human aliens will be as friendly to us as they appear to be!*■

REFERENCES.

1. Interview with Dr. Jacques Vallée. Review OMNI, January 1980.
2. I.S. Shklovskiy and Carl Sagan: *Intelligent Life in the Universe*. Dell Publishing Company, New York, 1966.
3. John Gribbin. *Timewarps*. Delacorte Press/ Eleanor Friede, New York, 1969.
4. James Trefil. *From Atoms to Quarks*, Scribners & Sons, New York, 1980.

CHUPACABRAS WIDESPREAD: THE ENIGMA GROWS. © BY JORGE MARTÍN, Editor of *EVIDENCIA OVNI* (Puerto Rico), and FSR Consultant.

(Translation from Spanish. G.C.) (*EVIDENCIA OVNI* No. 12 (1997))

With every day that passes we receive growing evidence of the presence of this anomalous creature on our planet, and of the fact that the U.S. Military Authorities have known of its reality for decades. In this article we present fresh reports which, combined with the account that we have already given (in *EVIDENCIA OVNI* No. 11) of the revelations made by our confidential informant "Don Ernesto", show clearly that the appearances of these creatures are spreading throughout the world. Read, and form your own opinion. J.M.

In our last issue (*EVIDENCIA OVNI* No. 11) we gave an exclusive account of the revelations made to us in confidence by "Don Ernesto" - a former member of the U.S. Armed Forces who, so he claims, belonged to a 'delicate' working team whose job was connected with the U.S. Army's investigations of crashed UFOs and with the seizure of these machines along with their crews.

He has revealed that in 1960, when engaged in investigating one of these cases, in the area near Roswell, New Mexico (this incident has of course no connection with the famous "Roswell Case" that had occurred in July 1947), he saw three live alien creatures held in captivity in a military establishment. One of them was a tall humanoid of a rather "human" aspect - slim, with a large bald head, with a delicate pale grey skin with faint pink tinge and eyes slightly larger than those of a human, and with a sad expression on its face which was of a reddish-pink shade. The other two creatures, he told me, were similar to what our media here in Puerto Rico call "*Chupacabras*".

As we have already said, that was in 1960, and he learned at that time that the three creatures had apparently been captured in a crashed alien or extraterrestrial craft somewhere in the USA. (He was not informed *where*).

Subsequently, as he told me, he learned further details about the "*chupacabras*", and this time it was in 1970, and in the Republic of Panama, in Central America, when he was sent on a special mission into the jungle there to collect information from the Indians and the Panamanian villagers about strange creatures that were killing their



Sr. Eddie Melvin

animals in some mysterious fashion.

And when he got there and spoke to the villagers and Indians, he was surprised to discover that the creatures they were describing were similar to those that he had seen in the cages, together with the humanoid being, at Roswell, New Mexico, USA, in 1960!

And "Don Ernesto" assured us that these creatures *are* of extraterrestrial origin, and that the U.S. Government knows this, and has known of their presence here among us since 1960 at the least, if indeed not even



El "Chupasangre" tal y como lo describen algunos testigos en Estanzuela, Zacapa, Guatemala, C.A.

The "Chupasangre" as described by witnesses in Estanzuela, Zacapa, Guatemala, C.A.



El "Chupacabras" según descripción de decenas de testigos en Puerto Rico.

The "Chupacabra" according to the description of dozens of witnesses in Puerto Rico.

earlier.

Well now, we have recently received fresh information that corroborates what "Don Ernesto" had said about these creatures having been appearing for decades past in the Panamanian Republic.

THE "DEVIL-CAT".

Mrs. Joyce Murphy, a lady from Texas, organizes excursions every year, for people interested in the UFO phenomén, to visit various parts of the world where there is intense UFO/alien activity, and to study the situation.

In view of the high level of such activity here on this Island of Puerto Rico, she has run such excursions to here for the past three years. On one of these excursions a participant was Mr. Eddie Melvin from the State of Washington (N.W. USA), who came here to study the "Chupacabras" *in situ*. We interviewed Mr. Melvin while he was here, and he told us a most interesting story which *proves* that the U.S. Armed Forces *have indeed known* of the existence of these sort of creatures *for a long time*, and he thus confirmed what "Don Ernesto" had told us about the presence of the "chupacabras" in Panama for decades past!

Eddie Melvin told us he had wanted to come to Puerto Rico because Joyce Murphy had sent him a fax with a copy of one of my sketches of the "chupacabra", and when he looked at it he was startled at the sight of the image shown, for it *at once reminded him of a similar creature that he himself had seen in Panama 31 years ago.*

He explained that, after many years of service in the U.S. Army, he retired in 1994. He had spent much of those service years in Communications, and had held high security classifications. And most of the time had been in Panama, as the USA has important military bases there. And it was there that he had his first contact with the phenomenon of the "chupacabras".

Around about 1965, he said, while stationed in Panama, he and his wife were talking with a woman servant in their employment. They had a cat, and this servant jokingly called him a "Gato Diablo" - "Devil-Cat". Although admittedly it seemed that this cat did look a bit grotesque, they were puzzled at her use of the term "devil", and they asked her why precisely she had said it. And her reply was that, back at her home in Rio Hato, in the western part of Panama, near the Pacific Coast, in a village close by some jungle, a very queer creature was killing the domestic animals. She said it did not eat them, but just killed them and then absorbed their blood, and she added that the Melvins' cat reminded her of that creature!

This aroused Mr. Melvin's curiosity, and he asked the servant whether they could go out there with her to her home in Rio Hato, to try to see one of those creatures? - and she said yes!

Some days later they arrived there. It was just getting dark, so she told them to come inside the house. Then she locked and bolted everything up and she told them to make no noise and to take up positions near the window



Rabbit killed, allegedly by a chupacabra, in Trujillo Alto, Puerto Rico. Note the perfectly circular aperture in the region of the animal's eye, which is characteristic of these attacks.

and watch....

And as luck would have it, they did not need to wait long. To their astonishment they saw the weird creature come out of the nearby forest, and very cautiously approach the house. Here is Mr. Melvin's amazing account:

"That thing was about 4ft high, and its body was covered with dark hair like the hair of a rat. Its head was oval-shaped, broad at the top and narrow and pointed at the jaws, with big red glowing almond-shaped, long drawn-out eyes. We couldn't see very clearly what it had in the way of a nose, owing to the darkness, but we could see that it seemed to have something like teeth protruding from its mouth. [This would, however, have been the long tongue, not teeth? G.C.]

"The creature was walking erect, on two very strong legs, thicker and more muscular at the top, and thinner down below. The feet seemed to have three claws. The torso was a bit narrower than the waist and the hips of the creature. It had two small, thin arms, also covered with dark hair and ending in hands with either three or four fingers with powerful claws.

"And then,, this thing or this animal or being, had things like spines or something of that sort running down its back from the lower base of the head right down to below, and those spines seemed to light up; they seemed as it were phosphorescent, with shades of different very faint colours. And when it raised its arms we saw that it had a sort of membrane under them which was joined on to the creature's thorax.

"Suddenly, this thing somehow became aware of our presence, for it turned its head very rapidly right towards where we were, and continued to gaze fixedly at the window. How it could have detected us, I cannot say, because we hadn't made the slightest noise. But it was

quite obvious that it knew we were there. So then it turned and rapidly went back into the bushes, the forest, and vanished."

From what Melvin told us, it seems that the servant explained that the presence of these creatures in Panama was something recent - that they had been appearing there from more or less about 1960. When he returned to the Military Base, he told his superiors what he had seen, but strangely enough they were unwilling to discuss the matter and told him that what he had seen was surely an iguana, or, as they call it locally, a *gallina de palo*, which they said were so abundant in the forests of Panama. Seeing that they were unwilling to talk about the matter, he decided to leave it at that, and said no more about it. But he never forgot what he had seen, and at the sight of our sketch of the "chupacabra" he was shaken, had seen one for the first time.

At that very same date in 1965 - and most likely not by coincidence - Panama was experiencing a massive UFO/Alien Wave. In fact, shortly after having seen the creature, Melvin and the members of his U.S. Army unit serving in Panama experienced a striking "close encounter of the third kind". *A great disc-shaped craft landed near them, on the grounds of the Army Base where they were. Everybody in the place was paralysed, and they were all examined by several humanoids of the slim "Grey" type, with long arms and hands with only four fingers, and with heads slightly larger than the average human head, but with skin of an intense orange shade and with large yellowish - orange eyes. These beings were clad in close-fitting one-piece overalls. They then returned into their craft, and when the craft had departed Melvin and his companions recovered their mobility.*

This experience of Melvin's - plus another one like it that he had later - will be described in a further exclusive

report in another issue of *EVIDENCIA OVNI*, - be ready and look out for it.

THE "CHUPACABRAS" GO INTERNATIONAL!

When, in 1995, the journalist/radio reporter Arnaldo García of Orocovis, in Puerto Rico, reported on the mysterious deaths of animals then occurring in his municipal area - right in the centre of the Island of Puerto Rico - he must have been far from realizing that the activities of the "chupacabras" were about to expand to international proportions!

And, since then, their presence and their doings have commenced in several other countries of Central America, and it is even said that, so far afield as Colombia, in South America, there have been a few deaths of animals due to these creatures.

But quite certainly one of the countries where (apart from Puerto Rico) they have been most evident and active, is Mexico, where they have been described as creatures "*having the physical characteristics of a vampire bat and a kangaroo, and with a touch of the features of an armadillo to complete the picture*".

An emergency search-and-rescue worker encountered one of the creatures at a reservoir near Agua Prieta, Sonora State, Mexico, and described it as "*a mixture between a turkey and a kangaroo, with a beak... and flying*".

The little town of Villalba, (Veracruz, Mexico) also received a visit from them, and they killed 20 hens there and drained them of their blood, through the usual

perforations. The hens had been roosting high up in trees [this is frequent in such countries. It is normal in Brazil. G.C.] The Villalba Chief of Police, Víctor Santiago, said:

"We can't explain it. Because it is difficult enough to catch *one* hen that is perched high up in a tree - but... *twenty!* It's a very weird, very complex case!"

In the nearby suburb of El Tuque, 16 ducks were massacred in similar fashion, while the farmers right through the State of Jalisco, on the Pacific Coast of Mexico, have had hundreds of cases of animals killed during the last few months.

A few weeks ago, one of these creatures was reportedly captured on land belonging to Alfonso Calderón, in the Mexican State of Sinaloa, but when a team sent by the Mexican Government arrived they found that it had already escaped, flying off towards the north.

IN GUATEMALA TOO.

Our Guatemalan friend and UFO-investigating colleague, Dr. Oscar Rafael Padilla Lara, President of the Investigative Association of Scientific Studies of Guatemala (AINECFOV) recently sent us an excellent report on the doings of these creatures in his country. In it he discusses certain events of this sort that happened in the region of Estanzuela and Zacapa, in Guatemala. His letter reads as follows:

"Some months ago I heard reports from the region of Estanzuela and Zacapa about the thing called hereabouts the "*Chupasangre*" ("Bloodsucker") - which I reckon

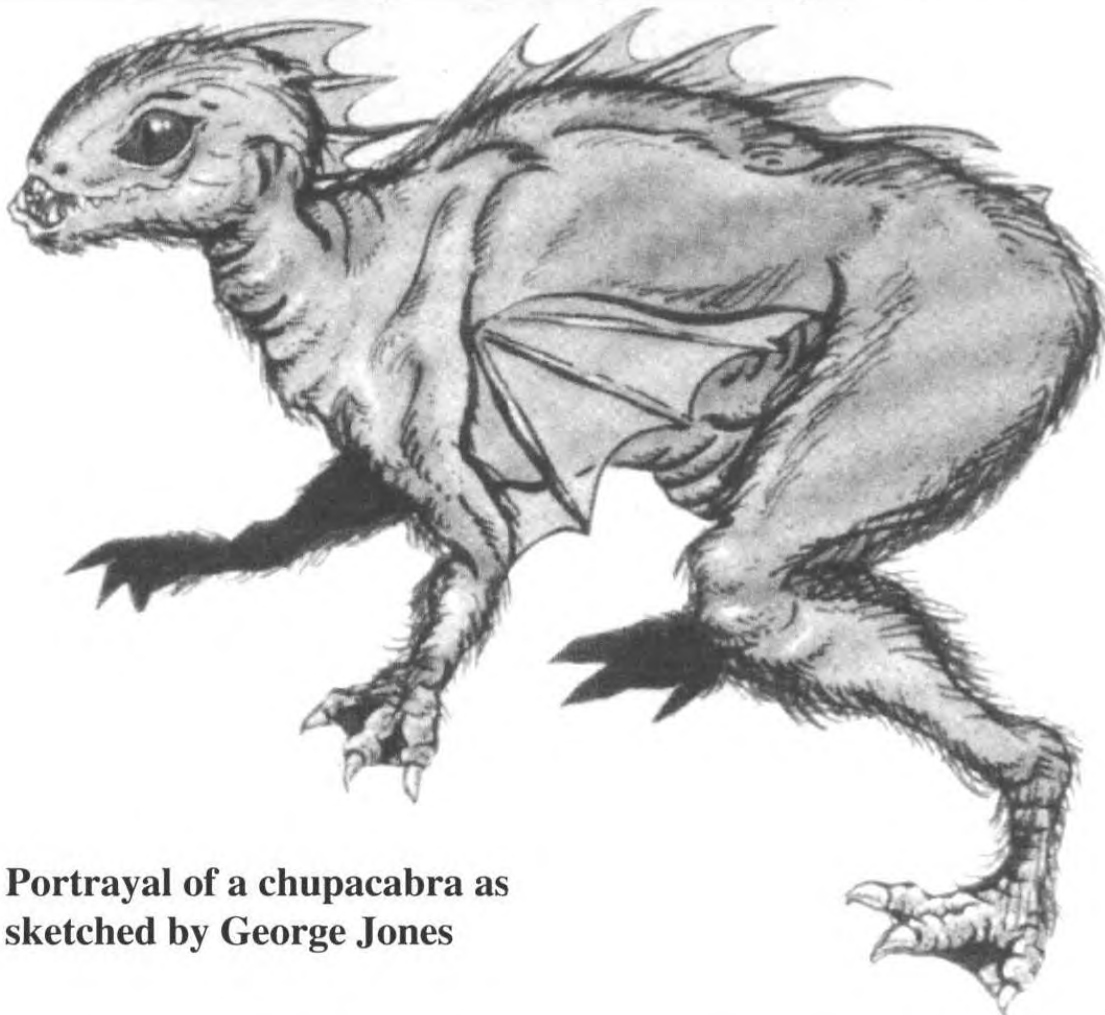

Portrayal of a chupacabra as sketched by George Jones

corresponds to what they call the “*chupacabras*” in Puerto Rico - but I was unwilling to take the reports seriously because, on various occasions, I have discovered that they did not seem accurate, or certain. But on this occasion I found, when I looked into it, that it was all certain. Having confirmed it all, I went to investigate, along with Señor Roland Castillo, Señor Miguel Alfredo Aguilera, and Señor Armando Vela. We got there at about 9.00 a.m. and, to my great surprise, I found that all the inhabitants of the region around that municipal centre knew about the creature.

“The business with the “*chupasangre*” in Guatemala began in the middle of October 1995, the person first affected being a woman named Galdámez, whose animals were the first known victims, and then the next was a lady professor, Alicia Fajardo de Cabrera, whose animals were involved on Saturday November 11, 1995, when she lost 150 hen chicks. To begin with, they were killing only poultry in pens. Later, adding up all the animals lost by various people, the number of killed animals came to over 200 (and the figure has since grown larger).

“When I interviewed Señora Fajardo de Cabrera about it, she told me that it had happened between 11.00 p.m. and 3.00 a.m. The next morning she said she heard the strange animal or entity arrive. She heard a humming sound, and a beating of wings, and she said that when the thing departed, it left behind a spiral mark on the ground [NOTE BY EDITOR JORGE MARTÍN: We have seen a similar effect in cases in Puerto Rico].

“The puzzling thing about this malignant being, as she terms it, is that it attacks birds in pens: small chicks, hens, cocks, ducks, turkeys, pigeons, and also wild birds such as quail. *And she adds, despite the fact that she has six very fierce dogs, the creature still managed to get in and do its dirty work.*

“As regards the method of attack, these creatures kill the animals and suck out their blood and other body fluids by means of two holes made in the neck. In the cases of the 150 hen chicks, it was found that every bird was lacking between half a glass and a glass of blood etc., which would give a total of some 5 gallons. So that the creature would have to be a large one to be able to absorb all that blood. [i.e. it is a five-gallon tanker! G.C.]

“Another anomaly is that after being dead for more than six hours, the bodies show no signs of *rigor mortis* and do not display the usual cadaverous signs of death.”

Another eyewitness, Señor Vicente Soza, aged 49, a stockbreeder, avers that he has seen a “chupacabra” on two occasions, both times at about 1.00 a.m., in January 1996. According to him, it looks like a black dog with a very long tail, and that, as it stood there in front of him, it grew in size and swelled up to the size of a large dog, and still stood there looking at him with deep red big eyes. Señor Rolando Fajardo and Señor Vitalino Galdámez, on the other hand, saw it more as a big shining black bird, like a cross between a vulture and a big bat, with blue eyes. Fajardo had fired at it, but without hitting it.

Other individuals who were eyewitnesses or victims are Professor Gonzalo Samayao, Dolores Echevarría, Héctor Portillo, Páblo Zúñiga, José Córdón and Haraldo Fajardo.

The veterinarians involved with these cases were Julio Morales Sandoval and Emilio Guzmán, along with other zootechnicians, biologists, lawyers, and newspapermen.

A small stream, called locally the “Quebrada del Jocote”, passes through the town, and it has some small caves along it large enough for a man to hide in, so such caves might be their hiding places.

The lady Professor Lilian Ramírez mentioned one particular incident, in which a young boy of 12 was alone in the house, waiting for his parents to return, when he encountered one of the creatures, which tried to enter the house. Then the parents arrived, they found the boy in a highly nervous, terrified state and with a high temperature, which the father then also acquired from him. [Possible result of radiation?].

Her husband, Sr. Federico Ramírez, emphasised that “the attacks have definitely occurred. But what is certain is that nobody has ever seen the animal or creature in the act of killing the animals, and we do not know for sure what the thing is”.

“On the other hand, Señor Julio Conde saw it on one occasion, and he is emphatic that it was walking along erect, just like a human, and furthermore he has noticed that the attacks are on a regular pattern, occurring with gaps of between 8 and 15 days. According to some people, the creatures get into the poultry pens by smashing through the wire meshing, *and when they come out through the holes they “lengthen” their bodies, as though possessed of no bones, but only of malleable cartilage, or as though they were like slugs or leeches, which can lengthen or shorten themselves.*”

SPECULATIONS.

On the basis of the foregoing descriptions, we might arrive at the following conjectures:

1. That this being or entity could be an antediluvian organism, prehistoric, or palaeontological, and on the basis of the fact that it has left plenty of traces on the spot, it could be a type of pterodactyl that has survived until our days.
2. That they could have come down from their lairs in the mountains on account of the forest fires on the Sierra de las Minas in our country (Puerto Rico), and they could simply be one species of our own wild animals, foxes, coyotes, anteaters, badgers, leopards, or weasels, which attack the domestic penned poultry - or indeed some species of gigantic vampire bat.
3. They might be some species of animal hitherto considered to be only mythological, such as the creatures depicted by gargoyles, some of which resemble them greatly.
4. Also, as some folk think, they could be transformations or transmutations of some animals into other animals, by means of witchcraft or satanism.
5. They could be animals produced by genetic experiments carried out by some terrestrial nation, but in

all cases they do show that they possess a certain degree of intelligence, since they can open doors closed with wire and have also got into completely closed cages.

FINAL CONCLUSIONS BY JORGE MARTÍN.

Looking at it all, and comparing it with the “Chupacabras” of Puerto Rico, Miami, Florida, and Los Angeles, plus other cases in Brazil and Venezuela, and other animal mutilation cases throughout the world - including also the so-called “*Sacalenguas*” cases [with tongues torn out] of El Salvador - my final conclusion must be that the “Chupasangre” of Guatemala is connected with entities of extraterrestrial origin.

Why do we reach this final conclusion? We reach it because the ‘*modus operandi*’ of all of these

anomalous creatures is similar, in that when they attack and kill the victims they do not tear and rip them, as an ordinary predator here would do, but confine themselves to extracting a certain quantity of blood from the victims along with certain specific organs, taken out via the same pattern of wounds. Furthermore, the fashion in which they appear and disappear, producing a powerful hum and a ‘circular energy’ (which creates the circular marks on the ground) is yet another factor to be considered. The radiation that has been found at the sites of some of the attacks is something else that we are going to have to take into account. Looking at all of this, it is my opinion that the entity must be of extraterrestrial origin, and I include it in the cases classified under the Third Type, Class B. ■

UFOS ESCORTED BY MYSTERIOUS “MILITARY MEN” IN BLACK? © BY JORGE MARTÍN, EDITOR OF *EVIDENCIA OVNI* (Puerto Rico), and FSR Consultant.

(Translation from Spanish. G.C.) (*EVIDENCIA OVNI* No.13 (1997))

The morning of January 21, 1997, will be an occasion that Señor Juan Hernández of Camuy, Puerto Rico, will never forget.

On that day, at about 1.30 am. Hernández was driving home to Camuy from Mayaguez, where he worked as a security guard, when he noticed a brilliant “star” in the sky - a “star” that suddenly seemed to be descending towards him.

In his own words: “I had crossed over the bridge over the river Camuy when I saw this light, apparently about a kilometre from me, and it was approaching. I stopped and got out. The light was now starting to change. From violet colour it was now turning to turquoise blue, and I could now see that it was a craft, and I estimated that it might be about 800 ft. wide and about 500 ft. long.

“It was vast, - enormous. It was triangular, and was now down to a height of about 80 - 100 ft. above me, and I could see lights on it, a row of iridescent lights as well as others that were changing colour all the time in sequence, red, yellow, blue, white. On top it had a cupola, inside which I could see the silhouette of what seemed to be a person, I would reckon, though I couldn’t see it very clearly. And it didn’t seem like a normal person, but tall, slender, with a strangely shaped head - *like a pear*, large in the upper part and smaller below at the jaws. The light was strong enough for me to see his eyes, which were big and dark, but I couldn’t see more details.

“Suddenly from the top part, the cupola, came a beam of light that shone on me. It wasn’t like the light of a torch, which becomes dispersed. As it came down, gradually it was controlled and keeping its shape, and, as it were, contained within itself, and it enveloped me. I was still standing there looking at the being in the cupola and now I felt a sensation of vast peace, a tranquility

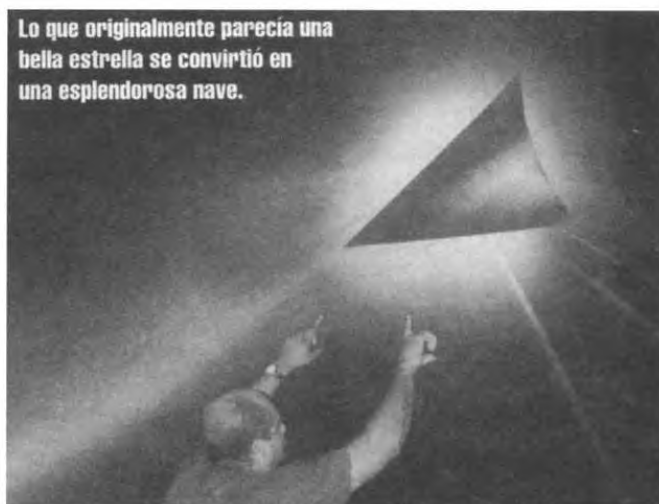

Lo que originalmente parecía una bella estrella se convirtió en una esplendorosa nave.

Fig. 1. What originally seemed to be a beautiful star then turned into a magnificent craft.

such as I had never known before.

“This seemed to last about three minutes or so, and I was able to see that in the centre on its underside the craft had, as it were, *blades* - about six or eight of them. It certainly wasn’t a helicopter. [See the eyewitness’s sketch in Fig. 2.] for, had it been, it would certainly have crashed. The blades, or whatever they were, were rotating very, very slowly, so it couldn’t have been them that was keeping it there hanging up in the air.

“It made no sound whatever. Then it withdrew the beam from me, and I saw it was starting to move. I got into the car, to follow it, but after I had gone only about 20 ft., a black 4 X 4 vehicle with darkened windows approached and blocked my way. It was a *Trooper* or a *Montero* [small vans? G.C.] I’m not sure which. I got out to ask its driver why he was barring my way like that,

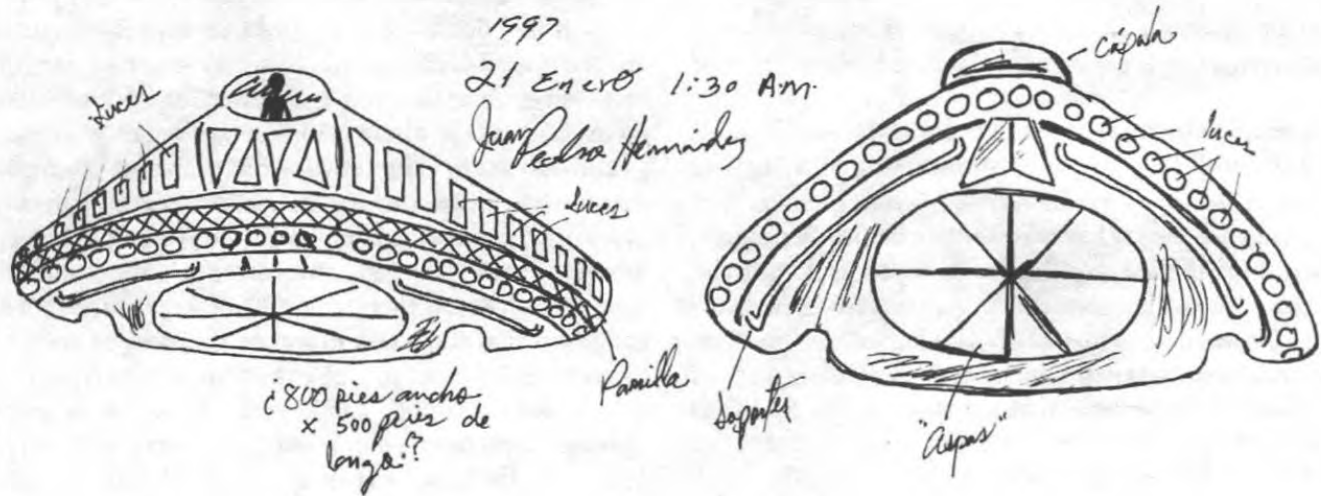

Fig. 2. Witness' sketch of the UFO showing "blades".

and requested him to let me by, and out came an individual dressed all in black. I asked him if he could see what I could see, and he said "If you're seeing it or are not seeing it is of no interest to me". And he told me not to follow it, and that I should let them do what they were going to do.

"He said this to me in a harsh, threatening fashion. He said that if I insisted on following it, something could happen to me".

I enquired whether he did not feel that the other might have said this rather in the sense of 'advice' since it wasn't known what the thing was? But, Hernández was adamant and insisted that the tone had been clearly threatening, and nothing less. Hernández continued: I replied: "Why can't I follow it? Why should 'something happen to me' if all I am doing is simply following a craft or an aeroplane or whatever it might be?" And he replied in an authoritarian tone: "You aren't going to follow it, and that's that!"

"At that point I walked closer to his vehicle and stood by his driving side door. And then he said to me: "That's as near as you'll come. Don't move from there!" From where I now stood I noticed that inside his vehicle there was a box with what looked like a radar and a panel with instrumentation on it - dials, meters, apparently sound meters, and all sorts of lights...."

"Where was all this equipment? "we asked. He replied: "It was all in the back of the van. It was like a radar set, because I have seen them and know them, and I could clearly see the panel, with the marker going round, and the point of light, apparently from the object or craft itself which was showing up on it.

"And inside the vehicle there were also three more individuals, also dressed in black. And one of them, who talked like a New Yorker - talking Spanish but with a half-American accent, suddenly said that two more craft were going to come. We all looked, and on the radarscope two more spots were indeed showing. And just at that

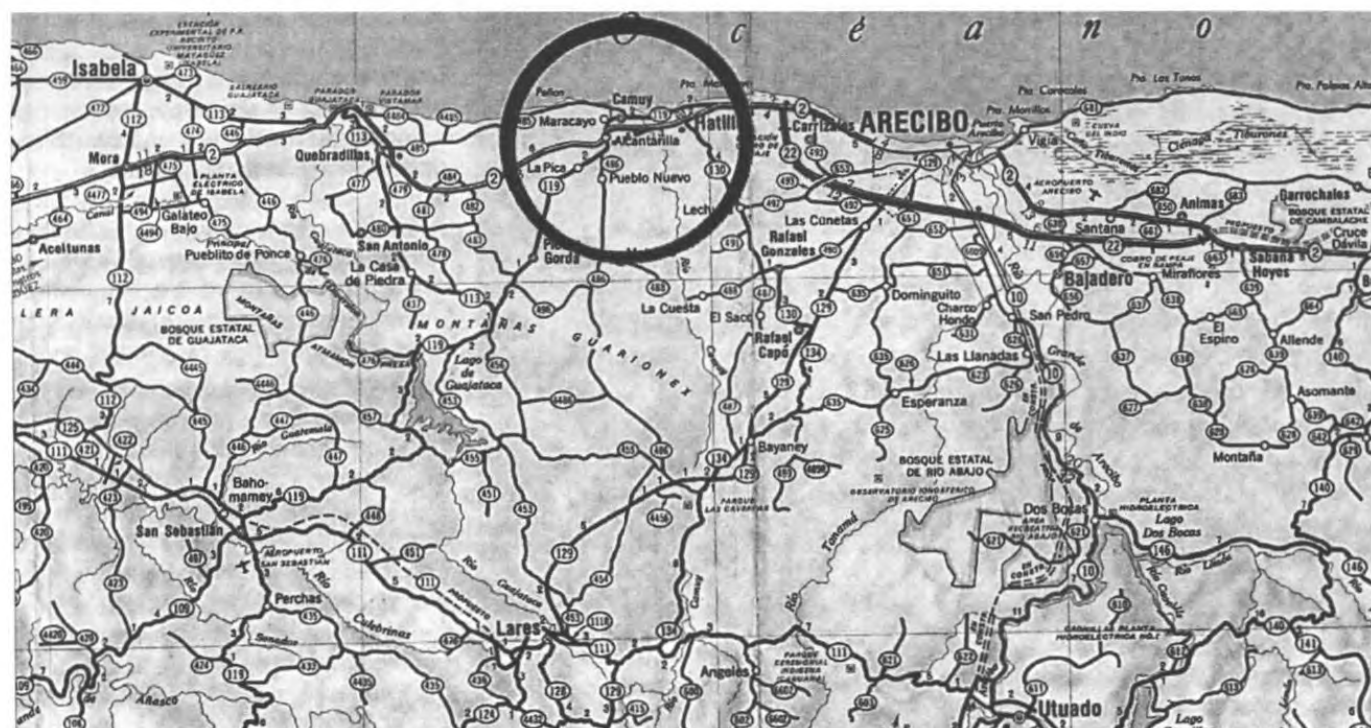

Fig. 3. Map showing location of Camuy, not far from Arecibo.

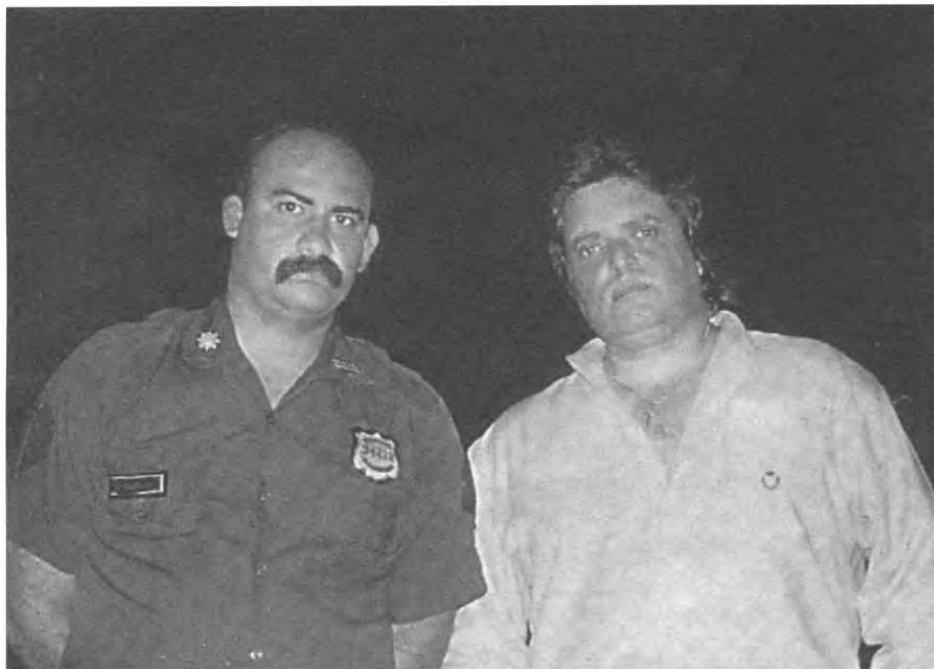

Fig. 4. Witness, Sr. Pedro Hernández next to Jorge Martín.

moment there started to be a roar from the sky, from something coming, though nothing was visible yet. Then, about half a minute later, two craft appeared, identical with the first one. *They were identical in everything, with the exception that these two craft made a noise.* The noise was just like the noise of turbine jets, and pretty loud. In fact it was unbearable, and I had to cover my ears as they went over.

“But - by the way - the other craft had made no noise! It had been silent. Then, as I watched, I noticed that the other craft - the first one - had started to move, and the other two were now pursuing it. We stood there watching. The first craft - the silent one - surrounded itself once more in the turquoise-blue light, and then it changed to a violet shade. The craft became completely enveloped in this violet glow and could no longer be seen - all you could see was a great ball of violet light.

“Then it started to rise, up and up and up, at high speed, finally becoming a tiny point of brilliant light lost among the stars. The other two craft rose only to a certain height, but it was clear that they could not reach the first one, and finally one of them went off to the left, towards Aguadilla, where the Ramey airport is, and the other one off towards the right.”

AT THIS POINT THE WITNESS SAID SOMETHING EXTREMELY IMPORTANT. He said:

“And, by the way, those two last craft couldn’t change colour and envelope themselves in that glow. Only the first craft enveloped itself in the light and vanished in Space. The other two didn’t. Furthermore, the first craft made no sound, and left no smoke trail, but the others left a line of smoke behind them... and those other two craft had on their back parts what looked like two big turbine jets, which seemed to be what was driving them, and they made the noise that, as we know, jets do. But the other craft, the first one - didn’t have them. I am absolutely sure of that”.

MYSTERIOUS PERSONNEL: MILITARY?

We returned to the matter of the presence of the mysterious person clad in black who had intervened with him, and we asked what he was like, and what details he could give us about the man.

He replied: “They did not identify themselves in any way whatsoever. Not as any sort of Government agents, nor did they have any type of military emblem or anything - they were merely dressed in black. You could sort of say it was the uniform used by the *Division de Saturación** of the Police Force, or by certain military people, of the Army, but

completely in black - like the SWAT kind, with dark glasses and a black hat.

“The hat had a triangle in front. This triangle was a patch, in the shape of a triangle and in the centre it had a black or dark blue colouring, and around the edges it had a phosphorescent yellow colour.

“Inside the triangle there were some letters. You could see them on the hat of the man who was at the radar, and, so far as I could see, they were a P, an E, an O, a V, a N, and one other letter.. I don’t know whether it was a J or what it was, because you couldn’t see it very clearly.

“Those people. I repeat, were dressed totally in black. I don’t know whether they were armed - at any rate I could not see any arms on the man who talked to me. They had no type of identification on them. No sort of badge, or distinguisher, no I.D. card - nothing. The vehicle, the 4 X 4 minivan, was also completely black and without identification marks of any kind. I took a good look at the number plate when they were leaving, but it wasn’t like the ones that we are familiar with here on the Island, because *it only had letters*, and they were the same letters as on the cap-badge.

“I asked them *why* I could not follow that craft, and they didn’t answer me. And again I said: “*I am seeing that thing. It’s incredible... Are you yourselves not seeing it?*” And they replied: “*It doesn’t interest us whether you are seeing it or not seeing it. Simply - don’t follow it! Period! And shut up!*”

“In my opinion, on the basis of my analysis of *their* attitude and *their* behaviour, they were *Military*. They were individuals just like us - they were slimly built, but physically excellent, very strong. They seemed to be Puerto Ricans. At least the one talking to me most was Puerto Rican. The one inside who said that the other two craft were coming, had a New York accent. There were four of them in all, so far as I could see.

“Among the equipment, they had a radar set and a machine that seemed to be recording the sounds from the craft, or something or other. I say that because I noticed that, when the first craft was there - which *didn’t* make any noise - a needle on the machine was tracing a straight



Fig. 5. José Quiñones and Marta Díaz at the location of the "celestial battles.

line on the paper coming out of it, but when the other two craft arrived, making the noise of turbines, the needle began to rise and to move and to make like *writing* on the paper. It was like when they give you an encephalographic reading, when a little bit of paper comes out with the recordings - something like that.... And on the other machines you could see what looked like meters, and there was something like a clock, which registered the decibels.

"I had by then moved off a bit in the direction of my car and I was still standing there, fascinated, looking at those three objects in the sky, because - I don't deny it - what I was seeing was really making a powerful impact on me. Then suddenly I heard a noise and was about to speak to them again, and I turned round and saw that they were already moving, and going off after those craft.

"Then I dashed to my own car and switched on and tried to follow them, and as they were already well ahead of me, I tried to take a short cut through one of the streets of the town and come out of Hatillo at another point, but by then they and their vehicle were out of sight and I couldn't find them."

We asked: "How do you yourself see this situation in which you were - the arrival of the first craft, and then of the other two which looked similar, but which had turbines apparently adapted to them, plus the presence and the behaviour of those mysterious unidentified individuals dressed in black?". He answered:

"In my honest opinion, the persons that intervened in this business have knowledge of those craft and are trying to imitate them, to copy them in every respect. With what purpose, I don't know - but my opinion is this: they are trying to present themselves to the public as being *them* (the ETs) and trying to show the public that those other folk, the supposed extraterrestrials, *are bad*, or are coming to devour us, to inflict damage, - all in order to create a false image of what those other personages - or whatever they are - can be.

"In my opinion the other two craft that I saw, which resembled the first one, were - so I think - the product of *terrestrial, human*, technology, maybe combined with

extraterrestrial technology that they've got or that they have captured. With what purpose... I don't know, but as there are animal mutilations appearing everywhere nowadays, all this leaves a nasty taste and a preoccupation in peoples' minds - a feeling that maybe somebody is trying to create this sort of situation where the public imagine that it is extra-terrestrials or some other sort of life that is coming here to this planet to exterminate the human race and seize control of the world. If I'm correct in that I don't know, but anyway that's my conception of it." [How "muddled up" this chap is! G.C.]

The witness also told us that, at the start, when he was confronted by only the first craft and the being whom he could see in its cupola, he experienced the feeling - already mentioned - of peace and tranquility, but that shortly afterwards, when the other two craft arrived, that pleasant sensation suddenly ended, and he then felt an ambience and a sensation of apprehension, heaviness and fear.

FURTHER INCIDENTS OF THE SAME KIND.

There have recently been a number of similar cases in Puerto Rico - and in all of them there has been the same sort of behaviour: A strange kind of craft of flying saucer type or triangular type appears in front of eyewitnesses and hovers stationary there and, in some cases, carries off animals - usually cattle - by means of a light beam and these animals are later found dead, and mutilated, with clear and perfect incisions and no blood.

But in some of these cases, and at the site of the incident, these same personnel, apparently military, and dressed in black and without any signs of identification, have also been seen. And with the same sort of 4 X 4 black vehicles, with 'smoked' windows, apparently escorting or protecting the mutilators' craft. And, moreover, trying to prevent people from being aware of their presence and of what they are doing.

BUT... WHO ARE THE CREWS OF THESE CRAFT? ARE THEY ETs, OR MILITARY PERSONNEL... OR BOTH? AND, IF SO, THEN ...WHY?

FINAL COMMENT.

In the case of Hernández, there was no animal mutilation as a feature (though there *was* a dairy farm quite close by).

But there were the two craft that seemed to him to be the products of terrestrial technology adapted *to look like* 'alien' or 'extraterrestrial' types of craft.

Well then - *why* - as he says - disguise terrestrial craft to make them look like extraterrestrial craft? (And in the case of Puerto Rico, it must mean that military personnel of the USA are seemingly involved in protecting the mutilators who - from the picture that appears - would allegedly be Extraterrestrials. And, furthermore, *why* should they be trying to prevent the public from becoming aware of this situation?

We find that we can only agree with eyewitness

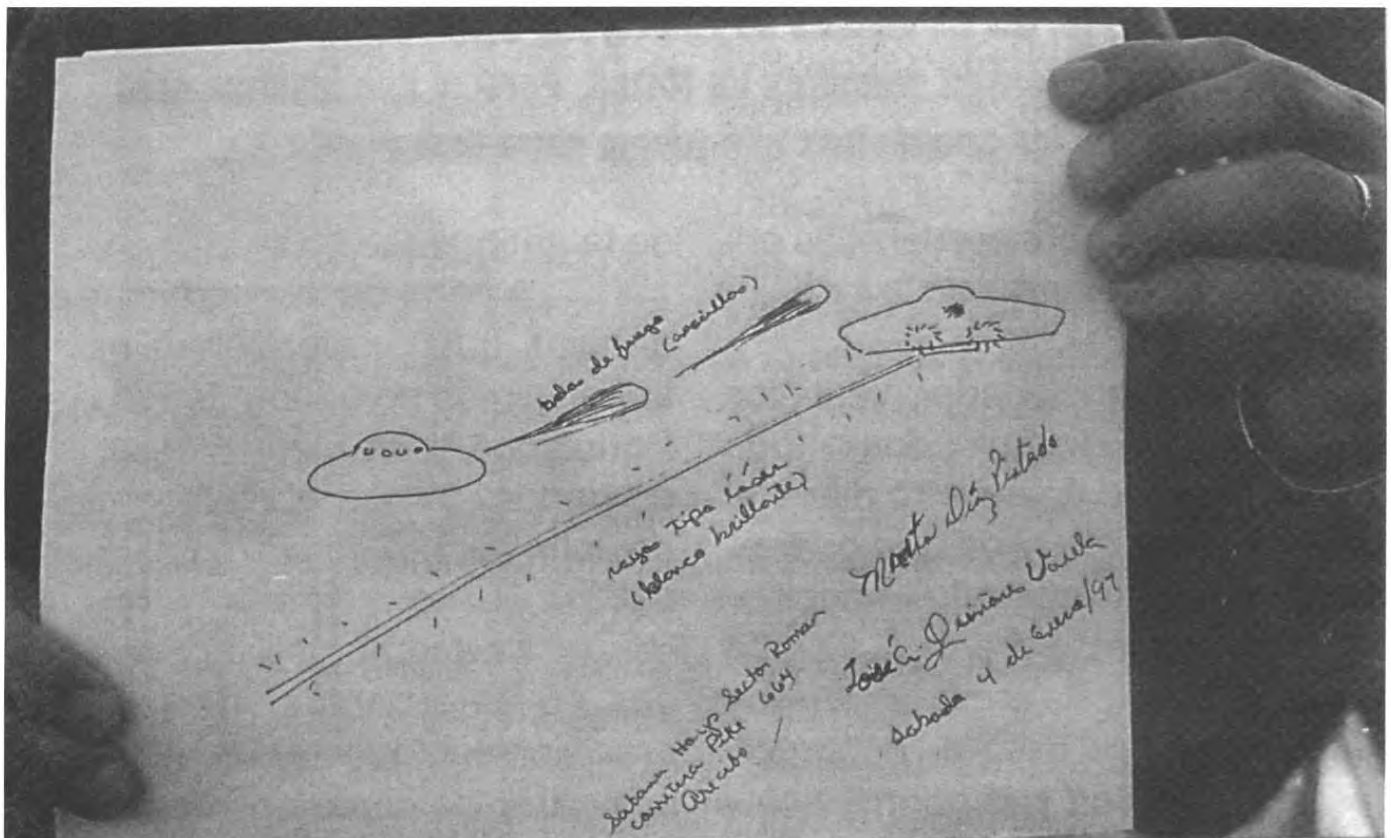

Fig. 6. Illustration by Sr. Quiñones of one of the battles he alleged to have seen.

Hernández in his feeling that “someone” desires to create a false scenario, in order - apparently - to promote the idea that the Extraterrestrials are real, but have hostile intentions and in reality want to conquer us and “devour” us all. [Is Jorge Martín being “taken in” too? G.C.]

“UFO BATTLES”?

Along with events such as the one described above, and UFO situations in the mountainous area of El Yunque (eastern end of the Island) and elsewhere, in which gigantic UFOs have been seen flying around overhead and even picking up “chupacabra” types of creatures by means of beams of light, there have been various other events that have been extremely disturbing, both for those who witnessed them, and for us who are students of this question. Because what has been seen was a situation wherein different types of flying saucers have been observed in what appear to be “battles” fought out in our skies.

Some of these incidents have occurred over Sabana Hoyos, in the Municipal Region of Arcibo, close to Camuy, where Hernández experienced the principal incident featured in this article.

From among these “battle incidents” we might make special mention of two or three that were observed by various local residents, including a Señor José Quiñones and a young lady named Marta Díaz Pintado. When we interviewed them about it, along with other witnesses, they told us how they had seen two different types of flying saucer appear in the sky and suddenly start attacking each other.

One of the types of UFO was discoidal, of an opaque metallic-grey colour, and with a cupola, and with a series of lights or illuminated windows around it - lights that

seemed to be rotating

The other type is fairly similar, but more “flattened” and longer, and it seems to have angles or corners. It too has a cupola, but smaller, and, unlike the first-mentioned type, it has two brilliant large white lights on its lower central part [see sketch by Señor Quinónes in Fig. 6] and a small base underneath.

According to all the eyewitnesses, while the UFOs make a series of rapid evolutions in the sky, seemingly each attempting to flee from the other, they fire at each other. The more elongated and flatter of the two shoots “laser type” light beams, of a very brilliant white colour, while the first-mentioned type, the more circular disc, fires very rapid yellowish “fireballs”.

Said Sr. Quiñones: “The strangest part of all is that I have seen all this a total of three times now - and it is always these same two types of craft - and although they go on shooting at each other for quite a while, neither of them seems to hit the other”.

This general picture supplied by the witnesses in the Sabana Hoyos district of Arcibo seems to us to be compatible with the idea of a put-up spectacle, something ‘staged’, the unfolding of a false scenario developed by some Governmental agency of the USA.*

Alright then. If so, why would they be doing that? Possibly because, as some people among the UFO-investigating community assert, as the alien/extraterrestrial presence in our world becomes ever more obvious, the Governments of the world - and especially the Americans - are preparing to reveal the reality of extraterrestrial life, but in doing so they will manipulate the news so as to make the population of our world believe that the visiting beings harbour hostile intentions, intentions dangerous to us,

thereby maintaining a control over human society by means of this massive deception of creating a new but false common enemy of external origin?

Could that be it? If so, why use Puerto Rico for it? In future issues we shall return to this and examine it more deeply.

NOTE BY EDITOR OF FSR.

* I have long considered Jorge Martín to be by far the wisest, most experienced, and certainly the most active and vigorous of the UFO investigators throughout the entire Spanish-American world, so I am really quite surprised to see him giving voice to such a weird and improbable theory as this!

That the eyewitness, Juan Hernández, should fall victim to this sort of wild idea is, however, possibly not so surprising. For he may very likely be under the alien mental influence, and there is plenty of reason to think that there are alien creatures around that delight in stirring up anti-governmental feelings throughout our world and promoting strife in general.

What a truly daft idea this is, that the Government of the United States should be acting as Hernández believes! And after all the mass of evidence that Jorge Martín has produced in his 13 or 14 issues of *EVIDENCIA OVNI*, Jorge must himself surely be totally convinced as to the utterly demonic nature of a very large part of the so-called "UFO activity", so how is it possible that he can, even for a moment, entertain such a concept!

I have good reason to think that nobody in our entire world today is more aware than Jorge Martín is of the fact that what we are experiencing is part of the titanic battle between the Forces of Darkness and the Light. And what have we seen *yet* that is more indicative of the presence of the Satanic Power in our world than the "*chupacabra*"?

As for the astonishing idea that the black-clothed men in the black van were "agents of the American Government" surely this is utter tosh. Surely it ought to be clear to every intelligent reader that they are far, far more likely to have been our dear old chums the MIBs!

I bet we'll soon have people earnestly assuring us that the MIBs and the Chupacabras are *themselves* the Higher Angelic Powers!

Finally, with regard to the idea of "battles between two sorts of UFOs", I find it very likely indeed that the people of Puerto Rico may be seeing precisely that! And I can think of two possible explanations for such a state of affairs.

The first explanation is that there could very likely be two species of Aliens, each possessed of craft that are not too dissimilar, who are fighting each other for the control of this Planet. It seems to me a very real possibility.

The second explanation might be - since we have received so many indications (from Colonel Philip J. Corso for example - that the USA have profited vastly from alien technology, - and indeed what is more likely? - that the Americans now have "saucer-shaped craft" of their very own and are trying them out in combat with the unpleasant creatures infesting Puerto Rico, an Allied and Associated State which the Americans are pledged to defend?

After all - as Colonel Corso has also confirmed, and as many of us have long suspected, the Governments of this planet are getting ready for the "Interplanetary War" that General Macarthur warned us of long, long ago, in his famous speech delivered in New York City and reported on in FSR at the time. For (again as Colonel Corso confirms), it seems clear that America's famous "*Star Wars Project*", so hated by all the pro-Commie rabble, was never designed for use against the Russians anyway, and I daresay the Russians too knew this, all along.

We will have more to say in the near future about General Macarthur, one of America's very greatest military leaders and statesmen of all time. As we shall show, and this is something that few today recall or even ever knew - he was actually one of the very first of the humans to become aware of the deadly threat from "aliens" and to warn about it. G.C.

TAILPIECE.

The latest reports received since the above was written now seem to indicate absolutely clearly that *two sorts of UFOs ARE* indeed being seen in Puerto Rico, one of them being used by "aliens" and the other by the U.S. forces *who appear to be allied with and under the control of - a second lot of "aliens"*. *So two lots of "Aliens" seem to be in conflict over possession of this planet - AND OF US, and one of these two lots of Aliens seems to have control over us at present. As to whether one of these lots of Aliens are "Goodies" and the other "Baddies" I suggest that so far we have no way of knowing. And it isn't necessary that either of the two factions should be "Goodies". "Baddies" have no reluctance about squabbling or killing each other, as everybody knows.*

As for the Angelic Powers - "Michael and his Cohorts" - I have never doubted for one second whether they exist. But they will have their own methods of operating. Some portion of what we tell the "UFO Phenomenon" may be their work. Perhaps it is too early to say.

Personally, therefore, I must repeat that I've no doubts as to the existence of the "U.S. Cavalry" nor do I doubt that, one of these days, we may see them "riding down over them thar hills". *But I don't see them yet.* G.C. ■

READERS' LETTERS

To Ken Mortimer, 2/Sept/02:

Dear Ken, Re: your article on Electromagnetic Gyroscopic Propulsion:

You are probably aware of the necessity for the rotating discs to carry an electric charge. I don't think you mentioned this.

In interstellar space there are vast regions of electromagnetic fields. These are studied in the field of magnetohydrodynamics.

A suggestion: Why not use solenoids with iron cores instead of those moving parts?

I am a friend of Bert Schwarz. He's a great guy.
Sincerely, Seymour Newman.

501 West 123 St.
New York, NY 10027

Fighters 'beaten by UFO'

Daily Mail, July 29, 2002

Dear Sir, As an avid reader of Flying Saucer Review for many years, I came across this article in the Daily

Mail, and thought I would send it to you. Other readers may also have sent it to you, but for the record it is a most recent sighting.

Yours sincerely, (Mrs) A.M. Tylee.

113 Holcombe Close,
Bathamton, Bath,
N.E. Somerset.
BA2 6UR

Two F-16 fighter jets armed with air-to-air missiles were scrambled to race across Washington in pursuit of a mysterious blue object travelling at 'phenomenal speed'.

The jets lost it somewhere over Waldorf, Maryland, about 30 miles from the capital.

Military spokesmen said radar had detected an unknown object, and two fighters from Andrews air force base were sent up to investigate.

They refused to speculate and would not describe it as a UFO.

Renny Rogers, who lives in Waldorf, said: "I saw this light blue object. There was one jet right behind it, chasing it, but the object was just leaving him in the dust."



We would like to take this opportunity of saying a very special thank you to all of our readers who have made donations. These have indeed helped to keep us afloat during the difficult times we are having, owing to dwindling subscriptions.

THANK YOU!

Uncovering the news you are not supposed to know.

natural health, human rights
suppressed news, UFOs
the unexplained, hidden history
future science and much more..

"Reading between the li(n)es"

NEXUS MAGAZINE

Sample issue £3.00.

1 year subscription £15.00 (6 issues)

Send cheque, PO,
payable to **NEXUS Magazine**,
or by VISA, Mastercard:

**NEXUS Magazine, 55 Queen's Road,
East Grinstead, West Sussex, RH19 1BG.
Tel: 01342-322854 ** Fax: 01342-324574**

BACK NUMBERS.

These contain a wealth of material, especially useful for serious students of the subject.

Trace the evolution of thought over years!
We are now offering a wider range of back numbers at reduced prices as follows:-
Sent by surface mail only.

Volumes 22 to 32: Regrettably these are no longer available.

Volumes 33 to 41: New A4 format, 1988-1996 inclusive, 4 larger loose issues per volume.
Cost Per Volume (incl. p.p): £7.00 UK, Overseas £8.00 or \$15.00

Volumes 44 & 45 are still £15 UK, Overseas £18 or \$35.00
Single issues are £4, overseas £5 or \$10.

THE HUMANOIDS.

A seminal work, first published in 1966. Edited by Charles Bowen, with contributions from Aimé Michel, Jacques Vallée, Gordon Creighton, Coral Lorenzen and Antonio Ribera. The first study ever made of the aliens!
Cost: £7.00 UK, overseas £8.00 or \$15.00
POSTAGE AND PACKING FREE, SURFACE MAIL ONLY

And while you are about it, what about buying an FSR tie, obtainable from the same address! Cost £7.00 or \$15.00.

All Payments to:
FSR Publications, Ltd,
PO Box 162
High Wycombe, Bucks.
HP13 5DZ

LIFE AND SOUL MAGAZINE

(FORMERLY REINCARNATION INTERNATIONAL)

The only publication exploring all aspects of immortality, including reincarnation, out-of-body experiences, spirit communication, karma, healing and parapsychological research.

Quarterly. 4 issues £12 (UK), £15 (Europe), £18 (world)

Cheques payable to "Karma Publishing Ltd" and send to: Dept. F, P.O. Box 119, Chipping Norton, OX7 6GR
Call **01993-832578** to pay by credit card.

THE CEREOLOGIST

(The Crop Circles Journal)

Published three times yearly

Editor: John Sayer

Single Copy: £3.00

Annual Subscription: £12 (UK), £15 (Europe), £18 or US\$35 (elsewhere), inc. p. & p.

Cheques and P.O.s made payable to:
The Cereologist, 17 Spindle Rd, Norwich, Norfolk. NR6 6JR
Tel: 01603 - 486722

<http://www.abel.co.uk/~sayer>
johnute@sayer.abel.co.uk

FLYING SAUCER REVIEW 1955-1994

Volume - Author- Article Index

By Edward G. Stewart

Large, softbound, 613 pages.

Price US\$ 60, plus handling/shipping costs (\$6 surface mail for international orders, and \$4 surface mail for US orders) Available from:

ARCTURUS BOOKS INC.

1443 S.E. Port St. Lucie Blvd.

Port St. Lucie

FLORIDA 34952, USA

Tel: (407) 398-0796 Fax: (407) 337-1701

LUMIERES DANS LA NUIT

The best UFO magazine in Continental Europe, now in its 41st year.

EDITOR: JOËL MESNARD.

Subscription Cost:-

France: 265F per annum.

Europe: 295F per annum.

The Americas and Africa:

325F per annum.

Australia: 345F per annum.

Payments to:-

Lumières dans La Nuit,

B.P. 3,

86800 Saint Julien-l'Ars,

FRANCE.

Our website address is:

<http://www.fsreview.net>